



Garantía de **Calidad**



ESTA LISTA DE PRECIOS PERTENECE A:

NOMBRE:

TIENDA:

DESCARGA LA LP 135 AQUÍ

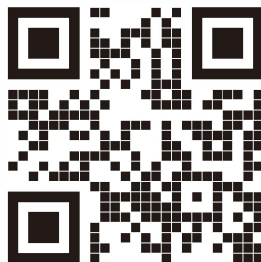

Garantía de **Calidad**



POR 73 AÑOS hemos mantenido la filosofía de fabricar todos nuestros productos, lo cual nos ha permitido llevar los estándares de calidad a niveles más altos, asegurándonos de ofrecerte la máxima experiencia en innovación, diseño, funcionamiento y durabilidad. Cada producto que desarrollamos es sometido a estrictas pruebas con el objetivo de que al usarlos, disfrutes una gran sensación de confort.

NUESTRA VOCACIÓN de ser fabricantes es lo que nos distingue y nos llena de mucho orgullo, porque con ella, año con año refrendamos nuestro compromiso hacia la innovación y la calidad, lo cual nos ha permitido llegar a otros países y conquistar la confianza de miles de personas, comercializando nuestros productos en más de 20 naciones, exportando nuestro lema de garantía de calidad a Estados Unidos, Canadá, Centroamérica, Sudamérica y el Caribe.

EN TODOS ESTOS AÑOS DE HISTORIA, hemos aprendido que lo más importante es brindarte el servicio más eficiente en asesoría, capacitación y servicio técnico especializado antes, durante y después de la compra. Por eso, día con día trabajamos para ofrecerte el mayor y mejor respaldo, tanto en garantía como en refacciones originales, que aseguren que tu Helvex siempre funcione.

Detrás de lo funcional y armonioso de los productos que creamos, existe un equipo de mujeres y hombres mexicanos, unidos por una regla de excelencia.

**- Ofrecer la máxima calidad -
Helvex, 73 años de ser la llave de México**

HELVEX®

Garantía de **Calidad**



**DESCARGA
EL FOLLETO
DE NUEVOS
PRODUCTOS**



HELVEX
Garantía de Calidad

**NUEVOS
PRODUCTOS
2023**



ÍNDICE



MANERALES

19

MEZCLADORAS Y MONOMANDOS

25

COMPLEMENTOS PARA LAVABO

57

ACCESORIOS

63

COCINA

109

REGADERAS

125

SALIDAS PARA TINA

167

COLADERAS

171

LLAVES PARA HOSPITAL

191



**LLAVES
ECONOMIZADORAS**

195

**LLAVES
ELECTRÓNICAS**

199

**ACONDICIONADOR
DE AGUAS DURAS**

205

**ACCESORIOS
INSTITUCIONALES**

207

FLUXÓMETROS

215

**MUEBLES SANITARIOS
Y LAVABOS**

225

**PAQUETES
INSTITUCIONALES**

263

ÍNDICE ALFANUMÉRICO

MODELO	DESCRIPCIÓN	PRECIO	PÁGINA
17	Portapapel con repisa para celular	\$ 1,486.00	107
22	Coladera corta de una boca lateral, de rejilla redonda removible	\$ 1,772.00	172
24	Coladera de una boca, de rejilla redonda	\$ 1,772.00	175
25	Coladera de tres bocas, rejilla redonda	\$ 1,972.00	180
26	Coladera de tres bocas, con tapa ciega redonda	\$ 2,032.00	182
27	Coladera alta de una boca, rejilla redonda de 25 cm	\$ 2,314.00	178
28	Coladera alta de tres bocas, rejilla redonda de 25 cm	\$ 2,472.00	182
34	Clásica. Portapapel vertical y/o de repuesto	\$ 1,517.00	67
100	Clásica. Jabonera de empotrar con agarradera	\$ 1,910.00	67
101	Clásica. Jabonera de empotrar con agarradera	\$ 1,717.00	67
104	Clásica. Portapapel de empotrar	\$ 1,730.00	68
105	Clásica. Toallero de barra	\$ 2,224.00	68
105-45	Clásica. Toallero de barra de 45 cm	\$ 2,072.00	68
106	Clásica. Gancho doble	\$ 743.00	68
107	Clásica. Portavasos cepillero	\$ 946.00	69
108	Clásica. Jabonera	\$ 1,096.00	69
109	Clásica. Toallero de argolla	\$ 1,099.00	69
110	Clásica. Portatoallas múltiple	\$ 4,457.00	70
114	Clásica. Portapapel de empotrar con cubierta	\$ 2,458.00	70
115	Clásica. Portapapel de empotrar con tubo antirrobo	\$ 2,086.00	70
117	Clásica. Portapapel	\$ 1,527.00	71
122	Clásica. Tendedero retráctil, longitud 3.25 m	\$ 1,840.00	71
123	Clásica. Destapador	\$ 696.00	71
124	Clásica. Portatoallas múltiple con toallero	\$ 5,650.00	71
158	Clásica. Agarradera para tina con jabonera de rejilla	\$ 4,788.00	72
205	Clásica II. Toallero de barra	\$ 2,224.00	73
205-45	Clásica II. Toallero de barra de 45 cm	\$ 2,072.00	73
206	Clásica II. Gancho doble	\$ 743.00	73
207	Clásica II. Portacepillos	\$ 946.00	73
208	Clásica II. Jabonera	\$ 1,092.00	74
209	Clásica II. Toallero de argolla	\$ 1,099.00	74
210	Clásica II. Portatoallas múltiple	\$ 4,457.00	74
215	Clásica II. Portapapel con tubo antirrobo	\$ 2,098.00	75
217	Clásica II. Portapapel	\$ 1,527.00	75
219	Clásica II. Portapapel doble con tubos antirrobo	\$ 3,359.00	75
223	Clásica II. Destapador	\$ 692.00	75
266	Clásica. Gancho multiusos reforzado	\$ 968.00	72
444	Coladera de cúpula para azotea	\$ 1,888.00	185
2104	Konos. Portapapel	\$ 1,448.00	84
2105	Konos. Toallero de barra	\$ 2,332.00	84
2106	Konos. Gancho doble	\$ 941.00	84
2107	Konos. Portacepillos	\$ 1,581.00	84
2108	Konos. Jabonera	\$ 1,602.00	85
2109	Konos. Toallero sencillo	\$ 1,527.00	85
2514	Coladera de rejilla redonda con campana	\$ 2,902.00	184
2584	Coladera de rejilla cuadrada, de acero inoxidable con campana	\$ 8,436.00	184
2714	Coladera de rejilla rectangular con campana	\$ 6,959.00	184
4954	Coladera de pretil para azotea	\$ 2,850.00	185
5424	Coladera de rejilla redonda, con canastilla para sedimentos	\$ 3,195.00	184
9105	Nuva. Toallero de barra	\$ 3,832.00	80
9106	Nuva. Gancho sencillo	\$ 1,501.00	80
9107	Nuva. Vaso cepillero de cristal	\$ 3,094.00	80
9109	Nuva. Toallero corto	\$ 2,374.00	80

ÍNDICE ALFANUMÉRICO

MODELO	DESCRIPCIÓN	PRECIO	PÁGINA
9117	Nuva. Portapapel	\$ 1,776.00	81
9124	Nuva. Portatoallas múltiple con toallero	\$ 5,890.00	81
9128	Nuva. Jabonera	\$ 2,965.00	81
14104	Kúbica. Portapapel	\$ 1,898.00	86
14105	Kúbica. Toallero de barra	\$ 4,135.00	86
14106	Kúbica. Gancho doble	\$ 1,608.00	86
14109	Kúbica. Toallero sencillo	\$ 2,545.00	86
15104	Premier. Portapapel	\$ 1,769.00	76
15105	Premier. Toallero de barra	\$ 3,166.00	76
15106	Premier. Gancho sencillo	\$ 773.00	76
15107	Premier. Portacepillos	\$ 1,595.00	76
15108	Premier. Jabonera	\$ 2,123.00	77
15109	Premier. Toallero sencillo	\$ 1,708.00	77
16104	Vértika. Portapapel	\$ 1,832.00	96
16105	Vértika. Toallero de barra	\$ 4,003.00	96
16106	Vértika. Gancho doble	\$ 1,544.00	96
16107	Vértika. Portacepillos	\$ 2,574.00	97
16108	Vértika. Jabonera	\$ 2,574.00	97
16109	Vértika. Toallero sencillo	\$ 2,445.00	97
20105	Máxima. Toallero de barra	\$ 3,166.00	88
20105-DN	◀ NUEVO Máxima. Toallero de barra. Acabado Duna	\$ 3,640.00	90
20105-EB	◀ NUEVO Máxima. Toallero de barra. Acabado Ébano	\$ 3,640.00	89
20105-TN	◀ NUEVO Máxima. Toallero de barra. Acabado Titanium	\$ 3,640.00	92
20106	Máxima. Gancho sencillo	\$ 773.00	88
20106-DN	◀ NUEVO Máxima. Gancho sencillo. Acabado Duna	\$ 889.00	90
20106-EB	◀ NUEVO Máxima. Gancho sencillo. Acabado Ébano	\$ 889.00	89
20106-TN	◀ NUEVO Máxima. Gancho sencillo. Acabado Titanium	\$ 889.00	92
20109	Máxima. Toallero sencillo	\$ 1,708.00	88
20109-DN	◀ NUEVO Máxima. Toallero sencillo. Acabado Duna	\$ 1,965.00	91
20109-EB	◀ NUEVO Máxima. Toallero sencillo. Acabado Ébano	\$ 1,965.00	89
20109-TN	◀ NUEVO Máxima. Toallero sencillo. Acabado Titanium	\$ 1,965.00	92
20117	Máxima. Portapapel	\$ 1,769.00	88
20117-DN	◀ NUEVO Máxima. Portapapel. Acabado Duna	\$ 2,034.00	91
20117-EB	◀ NUEVO Máxima. Portapapel. Acabado Ébano	\$ 2,034.00	89
20117-TN	◀ NUEVO Máxima. Portapapel. Acabado Titanium	\$ 2,034.00	92
110-38	Fluxómetro de manija para taza flux, spud de 38 mm. 6 L por descarga	\$ 7,604.00	215
110-38-3.5	◀ AHORRADOR Fluxómetro de manija para taza flux Nao, Nao17 y Nao a pared. 3. 5 L por descarga	\$ 7,604.00	215
110-WC-4.8	◀ AHORRADOR Fluxómetro de manija para taza flux, spud de 38 mm. 4.8 L por descarga	\$ 7,604.00	215
117-38	Fluxómetro de manija para taza flux, spud de 38 mm. 6 L por descarga	\$ 8,008.00	215
1342-35-CHL	Coladera de tres bocas, desagüe de contorno cuadrado	\$ 4,408.00	182
1342-35-CHLI	Coladera de tres bocas, desagüe de contorno cuadrado	\$ 4,408.00	182
1342-35CH	Coladera de tres bocas, rejilla cuadrada	\$ 3,800.00	183
1342-H	Coladera de tres bocas, rejilla redonda	\$ 2,822.00	183
1342-HL	Coladera de tres bocas, desagüe de contorno redondo	\$ 3,409.00	183
1342-HLI	Coladera de tres bocas, desagüe de contorno redondo	\$ 3,409.00	183
15104-EB	Premier. Portapapel	\$ 2,032.00	78
15105-EB	Premier. Toallero de barra	\$ 3,641.00	78
15106-EB	Premier. Gancho sencillo	\$ 889.00	78
15107-EB	Premier. Portacepillos	\$ 1,822.00	78
15108-EB	Premier. Jabonera	\$ 2,440.00	79
15109-EB	Premier. Toallero sencillo	\$ 1,963.00	79
185-19	Fluxómetro de manija para mingitorio. 3 L por descarga	\$ 7,604.00	218
185-19-0.5	◀ AHORRADOR Fluxómetro de manija para mingitorio. 0.5 L por descarga	\$ 7,604.00	218

ÍNDICE ALFANUMÉRICO

MODELO	DESCRIPCIÓN	PRECIO	PÁGINA
185-19-1	Flujómetro de manija para mingitorio. 1 L por descarga	\$ 7,604.00	218
22-CH	Coladera corta de una boca lateral, de rejilla cuadrada removible	\$ 1,939.00	172
22-CHL	Coladera corta de una boca lateral, desagüe de contorno cuadrado	\$ 2,248.00	172
22-CHLI	Coladera corta de una boca lateral, desagüe de contorno cuadrado	\$ 2,248.00	172
22-HL	Coladera corta de una boca lateral, desagüe de contorno redondo	\$ 2,087.00	173
22-HLI	Coladera corta de una boca lateral, desagüe de contorno redondo	\$ 2,087.00	173
22V	Coladera corta de una boca vertical, de rejilla redonda removible	\$ 1,772.00	173
22V-CH	Coladera corta de una boca vertical, de rejilla redonda removible	\$ 1,939.00	174
22V-CHL	Coladera corta de una boca vertical, desagüe de contorno cuadrado	\$ 2,248.00	174
22V-CHLI	Coladera corta de una boca vertical, desagüe de contorno cuadrado	\$ 2,248.00	174
22V-HL	Coladera corta de una boca vertical, desagüe de contorno redondo	\$ 2,087.00	175
22V-HLI	Coladera corta de una boca vertical, desagüe de contorno redondo	\$ 2,087.00	175
24-CH	Coladera de una boca, de rejilla cuadrada	\$ 1,939.00	176
24-CHL	Coladera de una boca, tapa redonda desagüe de contorno cuadrado	\$ 2,248.00	176
24-CHLI	Coladera de una boca, desagüe de contorno cuadrado	\$ 2,248.00	176
24-HL	Coladera de una boca, desagüe de contorno tapa redonda	\$ 2,087.00	177
24-HLI	Coladera de una boca, desagüe de contorno redondo	\$ 2,087.00	177
24-RHLI	Coladera rectangular de una boca, desagüe de contorno rectangular	\$ 5,139.00	177
24-RHLI-60	Coladera decorativa alargada de 60 cm	\$ 7,829.00	178
24-RHLI-90	Coladera decorativa alargada de 90 cm	\$ 10,277.00	178
25-CH	Coladera de tres bocas, rejilla cuadrada	\$ 2,128.00	180
25-CHL	Coladera de tres bocas, desagüe de contorno cuadrado	\$ 2,442.00	181
25-CHLI	Coladera cuadrada de tres bocas, desagüe de contorno	\$ 2,442.00	181
25-HL	Coladera de tres bocas, desagüe de contorno rejilla redonda	\$ 2,282.00	181
25-HLI	Coladera de tres bocas, desagüe de contorno redondo	\$ 2,282.00	181
282-35-CHL	Coladera de una boca desagüe de contorno cuadrado	\$ 5,139.00	179
282-35-CHLI	Coladera de una boca, desagüe de contorno cuadrado	\$ 5,139.00	179
282-35CH	Coladera de una boca, rejilla cuadrada	\$ 4,515.00	179
282-H	Coladera de una boca, rejilla redonda	\$ 3,315.00	179
282-HL	Coladera redonda de una boca, desagüe de contorno	\$ 3,908.00	180
282-HLI	Coladera de una boca, desagüe de contorno redondo	\$ 3,908.00	180
310-19	Flujómetro de pedal expuesto para mingitorio, spud de 19 mm. 3 L por descarga	\$ 9,146.00	217
310-19-0.5	← AHORRADOR Flujómetro de pedal expuesto para mingitorio, spud de 19 mm. 0.5 L por descarga	\$ 9,146.00	217
310-19-1	Flujómetro de pedal expuesto para mingitorio, spud de 19 mm. 1 L por descarga	\$ 9,146.00	217
310-38	Flujómetro de pedal expuesto para taza flux, spud de 38 mm. 6 L por descarga	\$ 9,146.00	216
310-38-3.5	← AHORRADOR Flujómetro de pedal expuesto para taza flux, spud de 38 mm. 3.5 L por descarga	\$ 9,146.00	216
310-WC-4.8	← AHORRADOR Flujómetro de pedal expuesto para taza flux, spud de 38 mm. 4.8 L por descarga	\$ 9,146.00	216
312-WC-4.8	← AHORRADOR Flujómetro de pedal expuesto para taza flux cuerpo oculto. 4.8 L por descarga	\$ 9,127.00	219
342-C	Rebosadero de rejilla cuadrada	\$ 1,168.00	186
342-CL	Rebosadero con desagüe de contorno cuadrado	\$ 1,340.00	186
342-R	Rebosadero de rejilla redonda	\$ 997.00	186
342-RL	Rebosadero con desagüe de contorno redondo	\$ 1,139.00	187
444-X	Coladera de cúpula para azotea	\$ 1,888.00	185
446-X	Coladera de cúpula para azotea	\$ 3,837.00	185
632-H	Rebosadero de rejilla rectangular de acero inoxidable	\$ 2,625.00	187
AC-110	Regadera de limpieza automática. Antirrobo con base al muro	\$ 3,320.00	130
AC110-8	← AHORRADOR Regadera de limpieza automática. Antirrobo con base al muro	\$ 3,320.00	130
AC10-TR011	Regadera de limpieza automática con válvula de control	\$ 2,974.00	130
AC20-TR011	Regadera de limpieza automática con válvula de control	\$ 3,777.00	130
AC50-TR011	Regadera de limpieza automática sin válvula de control	\$ 2,611.00	130
ACC-105	Access. Toallero de barra	\$ 2,046.00	63
ACC-105-EB	Access. Toallero de barra. Acabado Ébano	\$ 2,352.00	65
ACC-106	Access. Gancho sencillo	\$ 709.00	63

ÍNDICE ALFANUMÉRICO

MODELO	DESCRIPCIÓN	PRECIO	PÁGINA
ACC-106-EB	Access. Gancho sencillo. Acabado Ébano	\$ 814.00	65
ACC-107	Access. Portacepillos	\$ 933.00	63
ACC-107-EB	Access. Portacepillos. Acabado Ébano	\$ 1,072.00	66
ACC-108	Access. Jabonera	\$ 1,020.00	63
ACC-108-EB	Access. Jabonera. Acabado Ébano	\$ 1,172.00	66
ACC-109	Access. Toallero sencillo	\$ 1,104.00	64
ACC-109-EB	Access. Toallero sencillo. Acabado Ébano	\$ 1,269.00	66
ACC-117	Access. Portapapel	\$ 1,426.00	64
ACC-117-EB	Access. Portapapel. Acabado Ébano	\$ 1,640.00	66
AF-1	Asiento elongado para taza fluxómetro sin tapa	\$ 637.00	245
AF-2	Asiento plus elongado para taza fluxómetro sin tapa	\$ 1,271.00	245
AT-1	Asiento para WC elongado, frente abierto, cierre lento	\$ 1,160.00	240
AT-1-M	Asiento para WC elongado, frente abierto, cierre lento. Color marfil	\$ 1,160.00	240
AT-2	Asiento para WC, elongado, frente abierto, cierre estándar	\$ 736.00	240
AT-4	Asiento para WC elongado, con tapa envolvente, cierre lento	\$ 1,433.00	241
AT-5	Asiento para WC elongado, con tapa envolvente, cierre lento	\$ 1,160.00	241
ATE	Asiento electrónico. Incluye control remoto	\$ 24,936.00	242
ATM	Asiento tipo BIDEET mecánico	\$ 4,110.00	243
ATR-1	Asiento para WC redondo, frente abierto, cierre estándar	\$ 723.00	241
ATR-1-M	Asiento para WC redondo, frente abierto, cierre estándar. Color marfil	\$ 723.00	241
B-062-S	Barra angular Hockey 810 mm x 350 mm derecha Al	\$ 4,223.00	210
B-064-S	Barra angular Hockey 810 mm x 350 mm izquierda Al	\$ 4,223.00	210
B-066-S	Barra angular Boomerang 305 mm x 305 mm izquierda Al	\$ 3,167.00	210
B-305-S	Barra recta de seguridad 305 mm Al	\$ 1,860.00	208
B-470-S	Barra recta de seguridad 470 mm Al	\$ 1,860.00	208
B-610-S	Barra recta de seguridad 610 mm Al	\$ 1,971.00	208
B-700-S	Barra recta de seguridad 700 mm Al	\$ 2,021.00	208
BR-470	Barra de seguridad residencial antiderrapante	\$ 3,099.00	210
C-5	Flair. Juego de manerales grandes	\$ 1,371.00	19
C-12	Tritón. Juego de manerales grandes	\$ 1,390.00	19
C-14	Capri. Juego de manerales grandes	\$ 1,551.00	19
C-16	Rivoli. Juego de manerales grandes	\$ 1,551.00	19
C-20	Andros. Juego de manerales grandes	\$ 1,561.00	20
C-35	Trípoli. Juego de manerales grandes	\$ 1,551.00	20
C-37	Antiqua. Juego de manerales grandes	\$ 2,467.00	20
C-44	Antares. Juego de manerales grandes	\$ 1,447.00	20
C-45	Albatros. Juego de manerales grandes	\$ 1,447.00	21
C-46	Antea. Juego de manerales grandes	\$ 1,017.00	21
C-59	Ática. Juego de manerales grandes	\$ 1,447.00	21
C-62	Nuva. Juego de manerales grandes	\$ 2,862.00	21
C-65	Nuva. Juego de manerales grandes	\$ 2,862.00	22
C-67	Primma. Juego de manerales grandes	\$ 1,504.00	22
C-69	Kúbica. Juego de manerales grandes	\$ 2,982.00	22
C-70	Premier. Juego de manerales grandes	\$ 2,482.00	22
C-70-EB	Premier. Juego de manerales grandes. Acabado Ébano	\$ 2,853.00	23
C-73	Konos. Juego de manerales grandes	\$ 2,482.00	23
E-300	Elite. Monomando para fregadero	\$ 5,573.00	114
E-300-EB	Elite. Monomando para fregadero. Acabado Ébano	\$ 6,409.00	114
E-305	Gourmet. Monomando para fregadero profesional con resorte	\$ 15,377.00	115
E-306	Palma. Monomando para fregadero cabezal retráctil	\$ 13,260.00	116
E-307	Curvo. Monomando para fregadero cabezal retráctil magnético	\$ 12,384.00	117
E-308	Gourmet Twin. Monomando para fregadero profesional doble	\$ 17,235.00	118
E-309	Doria. Monomando para fregadero con dos tipos de chorro	\$ 7,889.00	119

ÍNDICE ALFANUMÉRICO

MODELO	DESCRIPCIÓN	PRECIO	PÁGINA
E-310	Doria. Monomando para fregadero sencillo de chorro fijo	\$ 6,978.00	120
E-310-EB	Doria. Monomando para fregadero sencillo de chorro fijo. Acabado Ébano	\$ 8,024.00	120
E-312	Adara. Monomando para fregadero, cabezal retráctil	\$ 9,452.00	121
E-32-EB	Nuva. Monomando para fregadero. Acabado Ébano	\$ 8,474.00	112
E-34	Novus. Monomando para fregadero	\$ 5,431.00	113
E-39	Ergo. Monomando para fregadero con cabezal retráctil	\$ 10,419.00	113
E-40	Ensamble triple de empotrar para regadera y tina	\$ 3,468.00	147
E-40-AQ	Ensamble triple de empotrar para regadera o tina	\$ 3,063.00	147
E-40-II	Ensamble triple de empotrar para regadera y tina	\$ 3,468.00	147
E-45	Novus. Monomando para regadera o tina	\$ 4,163.00	150
E-46	Nuva. Monomando para regadera o tina	\$ 5,481.00	154
E-47	Nuva. Monomando para regadera, tina o regadera manual	\$ 5,750.00	154
E-48	Kúbica. Monomando para regadera o tina	\$ 6,647.00	158
E-50	Ensamble triple de empotrar para regadera y tina	\$ 2,450.00	148
E-50-AQ	Ensamble triple de empotrar para regadera o tina	\$ 2,022.00	148
E-50-II	Ensamble triple de empotrar para regadera o tina	\$ 2,450.00	148
E-59	Explora. Monomando para regadera o tina	\$ 4,081.00	151
E-60	Juego de ensamblajes individuales de empotrar para regadera	\$ 1,390.00	148
E-60-AQ	Juego de ensamblajes individuales de empotrar para regadera	\$ 1,045.00	148
E-60-II	Juego de ensamblajes individuales de empotrar para regadera	\$ 1,390.00	148
E-61	Juego de ensamblajes individuales de empotrar para regadera	\$ 1,390.00	149
E-61-AQ	Juego de ensamblajes individuales de empotrar para regadera	\$ 1,045.00	149
E-61-II	Juego de ensamblajes individuales de empotrar para regadera	\$ 1,390.00	149
E-72	Mantiss. Monomando para regadera o tina	\$ 4,163.00	150
E-77	Aqua. Monomando para regadera o tina	\$ 4,188.00	150
E-700	Vértika. Monomando para regadera o tina	\$ 5,694.00	158
E-701	Vértika. Monomando para regadera, tina o regadera manual	\$ 6,267.00	158
E-702	Premier. Monomando para regadera o tina	\$ 5,258.00	156
E-702-EB	Premier. Monomando para regadera o tina. Acabado Ébano	\$ 6,051.00	156
E-703	Premier. Monomando para regadera, tina o regadera manual	\$ 5,960.00	157
E-705	Explora. Monomando para regadera, tina o regadera manual	\$ 4,779.00	151
E-708	Century. Monomando para regadera o tina	\$ 3,978.00	152
E-708-AU < NUEVO	Century. Monomando para regadera o tina. Acabado Aura	\$ 4,575.00	152
E-708-OB < NUEVO	Century. Monomando para regadera o tina. Acabado Obsidiana	\$ 4,575.00	152
E-709	Century. Monomando para regadera, tina o regadera con desviador	\$ 4,615.00	153
E-709-AU < NUEVO	Century. Monomando para regadera, tina o regadera con desviador. Aura	\$ 5,307.00	153
E-709-OB < NUEVO	Century. Monomando para regadera, tina o regadera con desviador. Obsidiana	\$ 5,307.00	153
E-710	Squadra. Monomando para regadera o tina	\$ 4,208.00	161
E-710-EB	Squadra. Monomando para regadera o tina. Acabado Ébano	\$ 4,839.00	161
E-711	Squadra. Monomando para regadera, tina o regadera manual	\$ 5,067.00	161
E-712	Máxima. Monomando para regadera o tina	\$ 4,182.00	162
E-712-DN < NUEVO	Máxima. Monomando para regadera o tina. Acabado Duna	\$ 4,809.00	163
E-712-EB < NUEVO	Máxima. Monomando para regadera o tina. Acabado Ébano	\$ 4,809.00	162
E-712-TN < NUEVO	Máxima. Monomando para regadera o tina. Acabado Titanium	\$ 4,809.00	163
E-713	Máxima. Monomando para regadera, tina o regadera con desviador	\$ 5,067.00	164
E-713-DN < NUEVO	Máxima. Monomando para regadera, tina o regadera con desviador. Duna	\$ 5,827.00	165
E-713-EB < NUEVO	Máxima. Monomando para regadera, tina o regadera con desviador. Ébano	\$ 5,827.00	164
E-713-TN < NUEVO	Máxima. Monomando para regadera, tina o regadera con desviador. Titanium	\$ 5,827.00	165
E-714	Nautilia. Monomando para regadera o tina	\$ 5,381.00	157
E-717-EB < NUEVO	Indus. Monomando para regadera o tina. Acabado Ébano	\$ 5,335.00	154
E-718-EB < NUEVO	Indus. Monomando para regadera o tina. Acabado Ébano	\$ 6,030.00	154
E-791	Century. Monomando para regadera, tina o regadera manual	\$ 5,986.00	153
E-793	Squadra. Monomando para regadera, tina o regadera manual	\$ 6,466.00	161

ÍNDICE ALFANUMÉRICO

MODELO		DESCRIPCIÓN	PRECIO	PÁGINA
E-907		Explora. Monomando de lavabo	\$ 5,561.00	44
E907-1.9	◀ AHORRADOR	Explora. Monomando de lavabo	\$ 5,561.00	44
E-907-CE		Explora. Monomando de lavabo	\$ 5,561.00	44
E907-CE-6	◀ AHORRADOR	Explora. Monomando de lavabo	\$ 5,561.00	44
E-908		Explora. Monomando de lavabo	\$ 5,158.00	44
E-908-CE		Explora. Monomando de lavabo	\$ 5,158.00	44
E-916		Konos. Monomando de lavabo	\$ 7,030.00	30
E-917		Clásica. Monomando de lavabo	\$ 6,043.00	31
E-917-AU	◀ NUEVO	Clásica. Monomando de lavabo. Acabado Aura	\$ 6,949.00	31
E-917-OB	◀ NUEVO	Clásica. Monomando de lavabo. Acabado Obsidiana	\$ 6,949.00	31
E-920		Álika. Monomando de lavabo	\$ 8,447.00	33
E-921		Álika alto. Monomando de lavabo	\$ 10,586.00	33
E-922		Bamboo. Monomando de lavabo	\$ 8,038.00	34
E-922-EB		Bamboo. Monomando de lavabo. Acabado Ébano	\$ 9,243.00	34
E-923		Bamboo alto. Monomando de lavabo	\$ 9,387.00	34
E-923-EB		Bamboo alto. Monomando de lavabo. Acabado Ébano	\$ 10,796.00	34
E-924		Nautilia. Monomando de lavabo	\$ 8,447.00	43
E-925		Nautilia alto. Monomando de lavabo	\$ 9,852.00	43
E-928		Century. Monomando de lavabo	\$ 5,269.00	32
E928-1.9	◀ AHORRADOR	Century. Monomando de lavabo	\$ 5,269.00	32
E-929		Squadra. Monomando de lavabo	\$ 5,436.00	42
E929-1.9	◀ AHORRADOR	Squadra. Monomando de lavabo	\$ 5,436.00	42
E-930	◀ Producto próximo a discontinuarse	Novara. Monomando de lavabo	\$ 7,220.00	42
E-937		Squadra alto. Monomando de lavabo	\$ 7,520.00	42
E-939		Land. Monomando de lavabo	\$ 6,043.00	48
E-939-EB	◀ NUEVO	Land. Monomando de lavabo. Acabado Ébano	\$ 6,949.00	48
E-940		Alba. Monomando de lavabo	\$ 8,038.00	49
E-941		Premier II. Monomando de lavabo	\$ 6,518.00	41
E-941-EB		Premier II. Monomando de lavabo. Acabado Ébano	\$ 7,497.00	41
E-943		Century alto. Monomando de lavabo	\$ 6,898.00	32
E-948		Scala. Monomando de lavabo	\$ 7,670.00	36
E-948-EB		Scala. Monomando de lavabo. Acabado Ébano	\$ 8,821.00	36
E-949		Scala alto. Monomando de lavabo	\$ 8,922.00	36
E-949-EB		Scala alto. Monomando de lavabo. Acabado Ébano	\$ 10,259.00	36
E-950-EB		Indus. Monomando de lavabo. Acabado Ébano	\$ 9,243.00	37
E-951-EB		Indus alto. Monomando de lavabo. Acabado Ébano	\$ 10,796.00	37
EP-3003		Nuva. Monomando de lavabo a pared	\$ 10,343.00	53
EP3003-1.9	◀ AHORRADOR	Nuva. Monomando de lavabo a pared	\$ 10,343.00	53
EP-3005		Kúbica . Monomando de lavabo a pared	\$ 12,308.00	53
EP-3007		Vértika. Monomando de lavabo a pared	\$ 11,015.00	54
EP-3007-DN	◀ NUEVO	Vértika. Monomando de lavabo a pared. Acabado Duna	\$ 12,667.00	54
EP-3007-EB		Vértika. Monomando de lavabo a pared. Acabado Ébano	\$ 12,667.00	54
EP-3007-TN	◀ NUEVO	Vértika. Monomando de lavabo a pared. Acabado Titanium	\$ 12,667.00	54
EP-905		Vértika. Monomando de lavabo	\$ 9,308.00	37
EP-909		Premier. Monomando de lavabo	\$ 7,099.00	39
EP-909-EB		Premier. Monomando de lavabo. Acabado Ébano	\$ 8,162.00	39
EP-932		Máxima mediano. Monomando de lavabo	\$ 7,304.00	46
EP-932-DN	◀ NUEVO	Máxima mediano. Monomando de lavabo. Acabado Duna	\$ 8,400.00	46
EP-932-EB	◀ NUEVO	Máxima mediano. Monomando de lavabo. Acabado Ébano	\$ 8,400.00	46
EP-932-TN	◀ NUEVO	Máxima mediano. Monomando de lavabo. Acabado Titanium	\$ 8,400.00	46
EP-933		Máxima alto. Monomando de lavabo	\$ 8,652.00	47
EP-933-DN	◀ NUEVO	Máxima alto. Monomando de lavabo. Acabado Duna	\$ 9,950.00	47
EP-933-EB	◀ NUEVO	Máxima alto. Monomando de lavabo. Acabado Ébano	\$ 9,950.00	47

MODELO		DESCRIPCIÓN	PRECIO	PÁGINA
EP-933-TN	◀ NUEVO	Máxima alto. Monomando de lavabo. Acabado Titanium	\$ 9,950.00	47
EP-938		Premier alto. Monomando de lavabo	\$ 9,122.00	40
EP-938-EB		Premier alto. Monomando de lavabo. Acabado Ébano	\$ 10,489.00	40
EP-94		Kúbica. Monomando de lavabo	\$ 10,161.00	42
EP-945		Nuva mediano. Monomando de lavabo	\$ 11,655.00	38
EP-947		Nuva alto. Monomando de lavabo	\$ 11,964.00	38
EP-99		Nuva. Monomando de lavabo	\$ 9,674.00	38
EP99-1.9	◀ AHORRADOR	Nuva. Monomando de lavabo	\$ 9,674.00	38
ES-001		Espejo de doble vista giratorio con aumento de 3x	\$ 5,699.00	106
ES-003		Espejo retráctil, aumento de 5x, con luz led	\$ 7,988.00	106
FB-110-38		Fluxómetro de sensor electrónico de baterías para taza flux, 6 L por descarga	\$ 20,435.00	222
FB-110-38-3.5	◀ AHORRADOR	Fluxómetro de sensor electrónico de baterías para tazas flux, 3.5 L por descarga	\$ 20,435.00	222
FB-110-WC-4.8	◀ AHORRADOR	Fluxómetro de sensor electrónico de baterías para taza flux, 4.8 L por descarga	\$ 20,435.00	222
FB-185-19		Fluxómetro de sensor electrónico de baterías para mingitorio, 3 L por descarga	\$ 20,435.00	223
FB-185-19-0.5	◀ AHORRADOR	Fluxómetro de sensor electrónico de baterías para mingitorio, 0.5 L por descarga	\$ 20,435.00	223
FB-185-19-1		Fluxómetro de sensor electrónico de baterías para mingitorio, 1 L por descarga	\$ 20,435.00	223
FC-110-38-3.5	◀ AHORRADOR	Fluxómetro de sensor electrónico para taza flux, 3.5 L por descarga	\$ 20,435.00	220
FC-110-WC-4.8	◀ AHORRADOR	Fluxómetro de sensor electrónico de corriente para taza flux, 4.8 L por descarga	\$ 20,435.00	220
FC-185-19		Fluxómetro de sensor electrónico para mingitorio, 3 L por descarga	\$ 20,435.00	221
FC-185-19-0.5	◀ AHORRADOR	Fluxómetro de sensor electrónico de corriente para mingitorio, 0.5 L por descarga	\$ 20,435.00	221
FC-185-19-1		Fluxómetro de sensor electrónico para mingitorio, 1 L por descarga	\$ 20,435.00	221
FERRY 1-1		Paquete institucional con fluxómetro de manija y mingitorio	\$ 9,112.00	267
FERRY FB-1		Paquete institucional con fluxómetro de sensor de baterías y mingitorio	\$ 14,746.00	268
FERRY FC-1		Paquete institucional con fluxómetro de sensor de corriente y mingitorio	\$ 14,746.00	268
H-100		Regadera de chorro fijo	\$ 2,365.00	125
H100-6	◀ AHORRADOR	Regadera de chorro fijo	\$ 2,365.00	125
H-102		Konos. Regadera de chorro fijo	\$ 1,096.00	125
H-105		Regadera de chorro fijo	\$ 3,771.00	125
H-13341G		Mezcladora de hospital 8" a 12" con cuello de ganso giratorio	\$ 7,225.00	193
H13341G-1.9	◀ AHORRADOR	Mezcladora de hospital 8" a 12" con cuello de ganso giratorio	\$ 7,225.00	193
H-200		Óptima. Regadera de chorro fijo	\$ 1,427.00	125
H200-6	◀ AHORRADOR	Óptima. Regadera de chorro fijo	\$ 1,427.00	125
H-201		Explora. Regadera de chorro fijo	\$ 1,656.00	126
H201-6	◀ AHORRADOR	Explora. Regadera de chorro fijo	\$ 1,656.00	126
H-201-AU	◀ NUEVO	Explora. Regadera de chorro fijo. Acabado Aura	\$ 1,904.00	126
H-201-EB	◀ NUEVO	Explora. Regadera de chorro fijo. Acabado Ébano	\$ 1,904.00	126
H-201-OB	◀ NUEVO	Explora. Regadera de chorro fijo. Acabado Obsidiana	\$ 1,904.00	126
H-202		Iguazú. Regadera de chorro vigorizante	\$ 1,578.00	127
H-202-EB		Iguazú. Regadera de chorro vigorizante. Acabado Ébano	\$ 1,815.00	127
H-3002		Kúbica. Regadera de chorro fijo, plato ancho	\$ 10,785.00	131
H-3003		Regadera de chorro fijo con sistema anticalcáreo plato ancho	\$ 3,406.00	131
H3003-8	◀ AHORRADOR	Regadera de chorro fijo con sistema anticalcáreo plato ancho	\$ 3,406.00	131
H-3004		Regadera de chorro fijo con sistema anticalcáreo plato ancho	\$ 3,406.00	131
H-3005		Premier. Regadera de chorro fijo con plato ancho	\$ 5,723.00	132
H3005-6	◀ AHORRADOR	Premier. Regadera de chorro fijo con plato ancho	\$ 5,723.00	132
H-3006		Kúbica. Regadera de chorro fijo con plato ancho	\$ 7,658.00	131
H3006-6	◀ AHORRADOR	Kúbica. Regadera de chorro fijo con plato ancho	\$ 7,658.00	134
H-3007		Regadera de chorro fijo con plato ancho	\$ 10,520.00	132
H-3008		Regadera redonda, plato ancho. Ultraplana de chorro fijo	\$ 9,373.00	136
H-3009		Regadera cuadrada, plato ancho. Ultraplana de chorro fijo	\$ 9,605.00	136
H-3010		Regadera redonda, plato ancho. Ultraplana de chorro fijo	\$ 9,405.00	137
H-3011		Regadera cuadrada, plato ancho. Ultraplana de chorro fijo	\$ 9,637.00	137
H-3013		Regadera cuadrada, plato ancho. Ultraplana de chorro fijo	\$ 14,701.00	137

ÍNDICE ALFANUMÉRICO

MODELO		DESCRIPCIÓN	PRECIO	PÁGINA
H-3300		Regadera multichorro. Con botón de cambios en el plato	\$ 2,298.00	138
H-3301-C/G		Regadera multichorro. Con palanca de cambios en el plato	\$ 2,824.00	138
H-3302		Regadera redonda multichorro de plato ancho	\$ 3,976.00	139
H-3302-C/B		Regadera redonda multichorro de plato ancho	\$ 3,976.00	139
H-3303		Regadera cuadrada multichorro de plato ancho	\$ 3,976.00	139
H-3303-C/B		Regadera cuadrada multichorro de plato ancho	\$ 3,976.00	139
H-500		Regadera de chorro fijo	\$ 1,675.00	128
H500-6	◀ AHORRADOR	Regadera de chorro fijo	\$ 1,724.00	128
H500-8	◀ AHORRADOR	Regadera de chorro fijo	\$ 1,724.00	128
H-600		Regadera de chorro fijo	\$ 1,427.00	128
H-7190		Desagüe para tina con sistema de push	\$ 3,376.00	169
H-8801		Contra-canasta para fregadero	\$ 2,413.00	122
H-8802	◀ NUEVO	Contra-canasta para fregadero con canastilla removible	\$ 1,476.00	122
H-900	◀ AHORRADOR	Nuva. Regadera de chorro fijo	\$ 2,960.00	129
H-904	◀ Producto próximo a discontinuarse	Vértika. Regadera de chorro fijo	\$ 4,156.00	129
H1000-TR011		Regadera de chorro regulable	\$ 3,801.00	131
H3005-TR035-AU	◀ NUEVO	Premier. Regadera de chorro fijo con plato ancho. Acabado Aura	\$ 8,437.00	133
H3005-TR035-EB		Premier. Regadera de chorro fijo con plato ancho. Acabado Ébano	\$ 8,437.00	133
H3005-TR035-OB	◀ NUEVO	Premier. Regadera de chorro fijo con plato ancho. Acabado Obsidiana	\$ 8,437.00	133
H3006-TR035-EB		Kúbica. Regadera de chorro fijo con plato ancho. Acabado Ébano	\$ 10,664.00	134
H3006-TR036-DN	◀ NUEVO	Kúbica. Regadera de chorro fijo con plato ancho. Acabado Duna	\$ 10,664.00	135
H3006-TR036-TN	◀ NUEVO	Kúbica. Regadera de chorro fijo con plato ancho. Acabado Titanium	\$ 10,664.00	135
HM-14		Antares. Mezcladora de lavabo 4"	\$ 5,130.00	25
HM-17		Albatros. Mezcladora de lavabo 4"	\$ 4,956.00	25
HM-18		Antea. Mezcladora de lavabo 4"	\$ 4,894.00	25
HM-21		Ática. Mezcladora de lavabo 4"	\$ 5,130.00	25
HM-22		Acaya. Mezcladora de lavabo 4"	\$ 4,894.00	26
HM-37		Albatros. Mezcladora para fregadero	\$ 5,215.00	109
HM-38		Flamingo. Mezcladora para fregadero	\$ 5,215.00	109
HOT-105		Explora. Toallero de barra	\$ 2,433.00	82
HOT-105-45		Explora. Toallero de barra de 45 cm	\$ 2,266.00	82
HOT-106		Explora. Gancho sencillo	\$ 821.00	82
HOT-107		Explora. Portacepillos	\$ 1,191.00	82
HOT-108		Explora. Jabonera	\$ 1,186.00	83
HOT-109		Explora. Toallero sencillo	\$ 1,618.00	83
HOT-117		Explora. Portapapel	\$ 1,559.00	83
IG-20		Interceptor de grasa con canastilla para sedimentos sólidos	\$ 20,701.00	188
IG-20-PTM		Interceptor de grasa de polietileno con tapa metálica	\$ 16,325.00	188
IG-40		Interceptor de grasa con canastilla para sedimentos sólidos	\$ 35,863.00	188
LUS-100		Lusitania. Monomando de lavabo	\$ 3,039.00	49
LUS-101		Lusitania alto. Monomando de lavabo	\$ 4,132.00	49
LUS-200		Lusitania. Monomando para regadera o tina	\$ 2,123.00	158
LV ALASKA	◀ NUEVO	Lavabo de sobreponer sin rebosadero	\$ 3,695.00	252
LV ANNI	◀ NUEVO	Lavabo de una perforación de sobreponer con rebosadero	\$ 2,091.00	252
LV CASSINI		Lavabo de sobreponer sin rebosadero	\$ 1,936.00	254
LV CASSINI M		Lavabo de sobreponer sin rebosadero. Color marfil	\$ 1,936.00	254
LV CLAP		Lavabo de sobreponer sin rebosadero	\$ 2 103.00	254
LV ELIPSIS	◀ NUEVO	Lavabo de sobrecubierta sin rebosadero	\$ 1,403.00	258
LV FUTURA1		Lavabo de una perforación de sobreponer con rebosadero	\$ 3,695.00	255
LV FUTURA1 M		Lavabo de una perforación de sobreponer con rebosadero. Color marfil	\$ 3,695.00	255
LV LUCERNA1		Lavabo de una perforación de sobreponer con rebosadero	\$ 3,695.00	255
LV LUCERNA1 M		Lavabo de una perforación de sobreponer con rebosadero. Color marfil	\$ 3,695.00	255
LV LUCERNA3		Lavabo de tres perforaciones de sobreponer con rebosadero	\$ 3,695.00	256

MODELO		DESCRIPCIÓN	PRECIO	PÁGINA
LV LUCERNA3 M		Lavabo de tres perforaciones de sobreponer con rebosadero. Color marfil	\$ 3,695.00	256
LV LUGANO		Lavabo de bajocubierta con rebosadero	\$ 1,762.00	259
LV MARCUS		Lavabo de sobrecubierta con rebosadero	\$ 2,203.00	258
LV MARCUS M		Lavabo de sobrecubierta con rebosadero. Color marfil	\$ 2,203.00	258
LV MARCUS BC		Lavabo de bajocubierta con rebosadero	\$ 2,385.00	259
LV MARCUS BC M		Lavabo de bajocubierta con rebosadero. Color marfil	\$ 2,385.00	259
LV MOREA		Lavabo de sobreponer sin rebosadero	\$ 1,403.00	256
LV MOREA EB	◀ NUEVO	Lavabo de sobreponer sin rebosadero. Color Ébano	\$ 1,838.00	256
LV MOREA1		Lavabo de una perforación de sobreponer con rebosadero	\$ 1,578.00	257
LV NARI	◀ NUEVO	Lavabo de sobreponer sin rebosadero	\$ 3,695.00	252
LV SANTORINI		Lavabo de sobreponer sin rebosadero	\$ 1,757.00	257
LV SANTORINI1		Lavabo de una perforación de sobreponer con rebosadero	\$ 2,091.00	257
LV SIRA	◀ NUEVO	Lavabo de sobreponer sin rebosadero	\$ 3,695.00	252
LV STALA		Lavabo de doble instalación sin rebosadero	\$ 2,260.00	258
LV TRAZZO		Lavabo de sobreponer sin rebosadero	\$ 2,215.00	256
LV TRAZZO M		Lavabo de sobreponer sin rebosadero. Color marfil	\$ 2,215.00	256
M-1005		Clásica. Mezcladora de lavabo 8" a 12"	\$ 7,904.00	29
M-1006		Nautilia. Mezcladora de lavabo 8" a 12"	\$ 11,081.00	29
MB-1011		Secador de Manos. Con botón accionador	\$ 9,142.00	211
MB-1012		Secador de Manos TURBO. Con sensor	\$ 14,631.00	211
MB-1012-AI		Secador de Manos TURBO. Con sensor	\$ 18,106.00	211
MB-1012-AIB		Secador de Manos TURBO. Con sensor	\$ 18,106.00	211
MB-1100		Dosificador electrónico con sensor para jabón líquido	\$ 6,636.00	212
MB-1101		Dosificador electrónico con sensor para jabón de espuma	\$ 7,773.00	212
MB-1102-AIB		Dosificador electrónico con sensor para jabón líquido	\$ 6,636.00	212
MB-1103-AIB		Dosificador electrónico con sensor para jabón de espuma	\$ 7,773.00	212
ME-302		Tritón. Mezcladora para fregadero	\$ 5,167.00	109
ME-303		Premier. Mezcladora para fregadero con cabezal retráctil magnético	\$ 9,855.00	110
ME-304		Premier. Mezcladora para fregadero. Cabezal movable 360°	\$ 8,953.00	111
MEP-2004		Iguazú. Mezcladora de lavabo 8" a 12"	\$ 6,436.00	27
MEP-2006		Nuva. Mezcladora de lavabo 8" a 12"	\$ 10,394.00	27
MEP2006-1.9	◀ AHORRADOR	Nuva. Mezcladora de lavabo 8" a 12"	\$ 10,394.00	27
MEP-2115		Premier. Mezcladora de lavabo 8" a 12"	\$ 11,225.00	27
MG FERRY	◀ AHORRADOR	Mingitorio flujo tipo cascada	\$ 8,691.00	247
MG GOBI TDS2	◀ AHORRADOR	Mingitorio seco con sistema TDS2	\$ 11,714.00	250
MG MOJAVE	◀ AHORRADOR	Mingitorio flujo tipo cascada	\$ 6,653.00	247
MG MOJAVE TDS2	◀ AHORRADOR	Mingitorio seco con sistema TDS2	\$ 8,965.00	249
MG NEGEV TDS2	◀ AHORRADOR	Mingitorio seco con sistema TDS2	\$ 11,714.00	249
MI-01-S/C		Elite. Mezcladora de lavabo 4"	\$ 3,577.00	26
MI01-S/C-1.9	◀ AHORRADOR	Elite. Mezcladora de lavabo 4"	\$ 3,577.00	26
MI-02-S/C		Primma. Mezcladora de lavabo 4"	\$ 4,051.00	26
MP-1000		Vértika. Mezcladora de lavabo 8" a 12"	\$ 11,753.00	28
MP-1000-DN	◀ NUEVO	Vértika. Mezcladora de lavabo 8" a 12". Acabado Duna	\$ 13,516.00	28
MP-1000-TN	◀ NUEVO	Vértika. Mezcladora de lavabo 8" a 12". Acabado Titanium	\$ 13,516.00	28
MR-1001		Vértika. Mezcladora individual de empotrar para regadera	\$ 3,665.00	149
MR-1005		Clásica. Mezcladora individual de empotrar para regadera	\$ 2,449.00	149
NAO 1-3.5		Paquete institucional con fluxómetro de manija y taza	\$ 8,520.00	263
NAO FB-3.5		Paquete institucional con fluxómetro de sensor de baterías y taza	\$ 14,213.00	264
NAO FC-3.5		Paquete institucional con fluxómetro de sensor de corriente y taza	\$ 14,213.00	266
NAO17 1-3.5		Paquete institucional con fluxómetro de manija y taza	\$ 8,520.00	264
NAO17 FB-3.5		Paquete institucional con fluxómetro de sensor de baterías y taza	\$ 14,213.00	265
NAO17 FC-3.5		Paquete institucional con fluxómetro de sensor de corriente y taza	\$ 14,213.00	267
OP CAPRI PLUS	◀ AHORRADOR	Inodoro cuadrado. Una sola pieza. Descarga de 4.8 LPD	\$ 11,919.00	226

ÍNDICE ALFANUMÉRICO

MODELO		DESCRIPCIÓN	PRECIO	PÁGINA
OP RIVOLI PLUS	◀ AHORRADOR	Inodoro elongado. Una sola pieza. Descarga de 4.8 LPD	\$ 11,919.00	225
PD-01-AI		Pedestal para dosificadores de jabón o gel	\$ 3,918.00	213
PIA-100		Piazza. Monomando de lavabo	\$ 3,039.00	50
PIA-100-EB	◀ NUEVO	Piazza. Monomando de lavabo. Acabado Ébano	\$ 3,495.00	50
PIA-101		Piazza alto. Monomando de lavabo	\$ 4,132.00	50
PIA-101-EB	◀ NUEVO	Piazza alto. Monomando de lavabo. Acabado Ébano	\$ 4,752.00	50
PIA-105		Piazza. Toallero de barra	\$ 1,319.00	93
PIA-105-EB	◀ NUEVO	Piazza. Toallero de barra. Acabado Ébano	\$ 1,517.00	94
PIA-106		Piazza. Gancho sencillo	\$ 389.00	93
PIA-106-EB	◀ NUEVO	Piazza. Gancho sencillo. Acabado Ébano	\$ 447.00	94
PIA-109		Piazza. Toallero sencillo	\$ 593.00	93
PIA-109-EB	◀ NUEVO	Piazza. Toallero sencillo. Acabado Ébano	\$ 682.00	94
PIA-117		Piazza. Portapapel	\$ 618.00	93
PIA-117-EB	◀ NUEVO	Piazza. Portapapel. Acabado Ébano	\$ 711.00	94
PIA-200		Piazza. Monomando para regadera	\$ 2,123.00	159
PIA-200-EB	◀ NUEVO	Piazza. Monomando para regadera. Acabado Ébano	\$ 2,441.00	159
PIU-05		Piura. Toallero de barra	\$ 4,352.00	95
PIU-06		Piura. Gancho sencillo	\$ 1,709.00	95
PIU-09		Piura. Toallero sencillo	\$ 2,703.00	95
PIU-100		Piura. Monomando de lavabo	\$ 10,795.00	52
PIU-101		Piura alto. Monomando de lavabo	\$ 13,597.00	52
PIU-17		Piura. Portapapel	\$ 2,019.00	95
PIU-200		Piura. Monomando para regadera o tina	\$ 7,040.00	165
PIU-201		Piura. Monomando para regadera, tina o regadera manual	\$ 8,014.00	165
REJ-01		Jabonera de rejilla rectangular	\$ 1,976.00	105
REJ-02		Repisa de rejilla esquinera	\$ 2,399.00	105
REJ-03		Repisa de rejilla semicircular doble	\$ 5,767.00	105
REJ-04		Repisa de rejilla rectangular doble	\$ 7,168.00	105
REJ-05		Repisa de rejilla esquinera doble	\$ 7,981.00	106
RM-7		Futura. Regadera manual	\$ 7,396.00	142
RM7-6	◀ AHORRADOR	Futura. Regadera manual	\$ 7,396.00	142
RM-14		Regadera manual	\$ 7,396.00	142
RM-15		Regadera manual	\$ 7,396.00	143
RM-17		Futura II. Regadera manual	\$ 7,396.00	143
RM-22		Nuva. Regadera manual de altura deslizable	\$ 5,812.00	145
RM22-6	◀ AHORRADOR	Nuva. Regadera manual de altura deslizable	\$ 5,812.00	145
RM-23		Regadera manual de altura deslizable	\$ 6,059.00	145
RM-24		Regadera manual de altura deslizable	\$ 7,192.00	146
RM-27		Regadera manual de altura deslizable	\$ 5,827.00	146
RM-28		Regadera manual de altura deslizable	\$ 5,348.00	146
RM-29		Regadera manual de altura deslizable	\$ 6,336.00	146
RM-30	◀ NUEVO	Whip. Regadera manual con soporte movible	\$ 4,238.00	144
RM-30-EB	◀ NUEVO	Whip. Regadera manual con soporte movible. Acabado Ébano	\$ 4,874.00	144
RM12-H101		Nuva. Regadera manual	\$ 7,396.00	143
SS-1		Acondicionador para aguas duras de corriente Sinsarro	\$ 7,781.00	205
S-TZF-P		Soporte para taza TZF Nao a Pared ajustable para dos alturas	\$ 4,511.00	246
TANQUE AUSTRAL		Descarga de 3.8 LPD. Botón accionador	\$ 1,825.00	231
TANQUE AUSTRAL P	◀ NUEVO	Descarga de 3.8 LPD. Palanca accionadora	\$ 1,825.00	232
TANQUE BOLMEN16		Descarga de 4.8 LPD. Botón accionador	\$ 2,221.00	233
TANQUE BOLMEN16 M		Descarga de 4.8 LPD. Botón accionador. Color marfil	\$ 2,221.00	233
TANQUE DRAKAR16		Descarga de 4.8 LPD. Botón accionador	\$ 1,820.00	234
TANQUE MIURA16		Descarga de 4.8 LPD. Botón accionador	\$ 3,703.00	230
TANQUE MIURA16 TCC		Descarga de 4.8 LPD. Botón de sensor y botón lateral manual	\$ 7,802.00	229

ÍNDICE ALFANUMÉRICO

MODELO		DESCRIPCIÓN	PRECIO	PÁGINA
TANQUE MURANO		Descarga de 4.8 LPD. Botón accionador	\$ 4,264.00	227
TANQUE OLIMPIA		Descarga de 3.8 LPD. Botón accionador	\$ 1,620.00	235
TANQUE OLIMPIA M		Descarga de 3.8 LPD. Botón accionador. Color marfil	\$ 1,620.00	235
TANQUE OPTION		Descarga de 4.8 LPD. Botón accionador	\$ 1,550.00	236
TANQUE OPTION P	◀ NUEVO	Descarga de 4.8 LPD. Palanca accionadora	\$ 1,550.00	237
TANQUE RÓDANO16		Descarga de 4.8 LPD. Botón accionador	\$ 2,221.00	238
TANQUE RÓDANO16 M		Descarga de 4.8 LPD. Botón accionador. Color marfil	\$ 2,221.00	238
TANQUE SUSTENTA	◀ NUEVO	Descarga de 2.5 LPD. Botón accionador	\$ 1,776.00	239
TAZA AUSTRAL		Taza elongada compacta y trampa expuesta	\$ 2,144.00	231
TAZA BOLMEN16		Taza elongada y trampa expuesta de altura confortable	\$ 3,334.00	233
TAZA BOLMEN16 M		Taza elongada y trampa expuesta de altura confortable. Color marfil	\$ 3,334.00	233
TAZA DRAKAR16		Taza elongada y trampa expuesta de altura confortable	\$ 2,725.00	234
TAZA MIURA16		Taza elongada y trampa oculta. Desalojo perfecto	\$ 5,555.00	229
TAZA MURANO		Taza elongada y trampa oculta de altura confortable	\$ 6,398.00	227
TAZA OLIMPIA		Taza redonda y trampa expuesta.	\$ 2,435.00	235
TAZA OLIMPIA M		Taza redonda y trampa expuesta. Color marfil	\$ 2,435.00	235
TAZA OPTION		Taza elongada compacta y trampa expuesta	\$ 2,329.00	236
TAZA RÓDANO16		Taza elongada y trampa expuesta de altura confortabe	\$ 3,334.00	238
TAZA RÓDANO16 M		Taza elongada y trampa expuesta de altura confortabe. Color marfil	\$ 3,334.00	238
TAZA SUSTENTA	◀ NUEVO	Taza elongada y trampa expuesta de altura confortabe	\$ 2,663.00	239
TH-001		Tubo extensión de 37 cm para contra de lavabo	\$ 590.00	59
TH-058		Contra con rejilla para lavabo con rebosadero	\$ 1,504.00	57
TH-059		Contra con rejilla para lavabo sin rebosadero	\$ 1,504.00	57
TH-062		Contra tipo hongo para lavabo con rebosadero	\$ 1,454.00	57
TH-063		Contra tipo hongo para lavabo sin rebosadero	\$ 1,454.00	57
TH-064		Contra de push para lavabo con rebosadero	\$ 1,742.00	58
TH-064-EB		Contra de push para lavabo con rebosadero. Acabado Ébano	\$ 2,003.00	58
TH-065		Contra de push para lavabo sin rebosadero	\$ 1,742.00	58
TH-065-EB		Contra de push para lavabo sin rebosadero. Acabado Ébano	\$ 2,003.00	58
TH-100		Maneral central	\$ 773.00	23
TH-101		Maneral central	\$ 1,114.00	23
TH-148		Elite. Salida para tina a pared	\$ 2,471.00	167
TR-011		Brazo y chapetón para regadera	\$ 632.00	140
TR-012		Brazo y chapetón para regadera	\$ 695.00	140
TR-013		Brazo y chapetón cuadrado para regadera	\$ 805.00	140
TR-035		Brazo y chapetón angular para regadera de plato ancho	\$ 1,580.00	140
TR-036		Brazo y chapetón cuadrado para regadera de plato ancho	\$ 2,258.00	141
TR-037		Brazo y chapetón al techo redondo para regadera	\$ 1,508.00	141
TR-038		Brazo y chapetón al techo cuadrado para regadera	\$ 1,998.00	141
TR-039		Brazo y chapetón angular para regadera	\$ 2,595.00	141
TUB-05	◀ NUEVO	Tubular. Toallero de barra	\$ 2,224.00	98
TUB-05-AU	◀ NUEVO	Tubular. Toallero de barra. Acabado Aura	\$ 2,558.00	101
TUB-05-EB	◀ NUEVO	Tubular. Toallero de barra. Acabado Ébano	\$ 2,558.00	99
TUB-05-OB	◀ NUEVO	Tubular. Toallero de barra. Acabado Obsidiana	\$ 2,558.00	103
TUB-06	◀ NUEVO	Tubular. Gancho sencillo	\$ 743.00	98
TUB-06-AU	◀ NUEVO	Tubular. Gancho sencillo. Acabado Aura	\$ 855.00	101
TUB-06-EB	◀ NUEVO	Tubular. Gancho sencillo. Acabado Ébano	\$ 855.00	99
TUB-06-OB	◀ NUEVO	Tubular. Gancho sencillo. Acabado Obsidiana	\$ 855.00	103
TUB-09	◀ NUEVO	Tubular. Toallero sencillo	\$ 1,099.00	98
TUB-09-AU	◀ NUEVO	Tubular. Toallero sencillo. Acabado Aura	\$ 1,265.00	102
TUB-09-EB	◀ NUEVO	Tubular. Toallero sencillo. Acabado Ébano	\$ 1,265.00	100
TUB-09-OB	◀ NUEVO	Tubular. Toallero sencillo. Acabado Obsidiana	\$ 1,265.00	104
TUB-10	◀ NUEVO	Tubular. Portatoallas múltiple	\$ 4,457.00	98

ÍNDICE ALFANUMÉRICO

MODELO	DESCRIPCIÓN	PRECIO	PÁGINA
TUB-10-AU	◀ NUEVO Tubular. Portatoallas múltiple. Acabado Aura	\$ 5,126.00	102
TUB-10-EB	◀ NUEVO Tubular. Portatoallas múltiple. Acabado Ébano	\$ 5,126.00	100
TUB-10-OB	◀ NUEVO Tubular. Portatoallas múltiple. Acabado Obsidiana	\$ 5,126.00	104
TUB-17	◀ NUEVO Tubular. Portapapel sencillo	\$ 1,527.00	99
TUB-17-AU	◀ NUEVO Tubular. Portapapel sencillo. Acabado Aura	\$ 1,755.00	103
TUB-17-EB	◀ NUEVO Tubular. Portapapel sencillo. Acabado Ébano	\$ 1,755.00	101
TUB-17-OB	◀ NUEVO Tubular. Portapapel sencillo. Acabado Obsidiana	\$ 1,755.00	104
TUB-35	◀ NUEVO Tubular. Portapapel con soporte de apoyo tipo barra de seguridad	\$ 2,290.00	99
TUB-35-AU	◀ NUEVO Tubular. Portapapel con soporte de apoyo tipo barra de seguridad	\$ 2,633.00	103
TUB-35-EB	◀ NUEVO Tubular. Portapapel con soporte de apoyo tipo barra de seguridad	\$ 2,633.00	101
TUB-35-OB	◀ NUEVO Tubular. Portapapel con soporte de apoyo tipo barra de seguridad	\$ 2,633.00	104
TV-002	◀ NUEVO Fusión. Salida electrónica con dispensador de jabón	\$ 16,334.00	199
TV-012	Válvula de paso roscable	\$ 807.00	261
TV-016	Césped para lavabo con registro	\$ 1,725.00	60
TV-016-EB	◀ NUEVO Césped para lavabo con registro. Acabado Ébano	\$ 1,984.00	60
TV-016-40	Césped para lavabo de 40 cm de largo con registro	\$ 2,163.00	60
TV-016-40-EB	◀ NUEVO Césped para lavabo de 40 cm de largo con registro. Acabado Ébano	\$ 2,487.00	60
TV-017	Césped para lavabo con registro	\$ 1,999.00	61
TV-017-EB	◀ NUEVO Césped para lavabo con registro. Acabado Ébano	\$ 2,299.00	61
TV-017-40	Césped para lavabo de 40 cm de largo con registro	\$ 2,295.00	61
TV-017-40-EB	◀ NUEVO Césped para lavabo de 40 cm de largo con registro. Acabado Ébano	\$ 2,639.00	61
TV-030	Césped para fregadero con registro	\$ 2,481.00	123
TV-031	Conexión para céspol. Tarja doble	\$ 2,220.00	123
TV-060	Nuva. Salida para tina a pared	\$ 3,537.00	167
TV-061	Nuva. Salida para tina a pared	\$ 3,829.00	167
TV-062	Premier. Salida para tina a pared	\$ 2,621.00	167
TV-062-EB	Premier. Salida para tina a pared. Acabado Ébano	\$ 3,015.00	168
TV-064	Olimpo. Salida para tina a pared	\$ 2,187.00	168
TV-069	Vértika. Salida para tina a pared	\$ 3,940.00	168
TV-081	Vértika. Salida para tina a piso	\$ 7,016.00	168
TV-100	Llave de lavabo economizadora a pared	\$ 3,874.00	195
TV-105	Llave de lavabo economizadora	\$ 3,692.00	195
TV105-2	◀ AHORRADOR Llave de lavabo economizadora	\$ 3,692.00	195
TV-106	Stala. Llave de lavabo economizadora	\$ 3,479.00	196
TV-121	Llave de lavabo temporizadora a pared	\$ 4,452.00	196
TV121-1.9	◀ AHORRADOR Llave de lavabo economizadora a pared	\$ 4,452.00	196
TV-122	Llave de lavabo temporizadora a piso	\$ 4,245.00	196
TV122-1.9	◀ AHORRADOR Llave de lavabo economizadora a piso	\$ 4,245.00	196
TV-190	Nimbus. Llave de lavabo electrónica de proximidad. De baterías de litio 6V	\$ 16,145.00	200
TV190-1.9	◀ AHORRADOR Nimbus. Llave de lavabo electrónica de proximidad. De baterías de litio 6V	\$ 16,145.00	200
TV-200	Nuva. Llave de lavabo electrónica de sensor a pared. De baterías alcalinas AA	\$ 15,545.00	200
TV-200-C	Nuva. Llave de lavabo electrónica de sensor a pared. De corriente	\$ 16,379.00	200
TV-201	Llave de lavabo electrónica de sensor a pared. De baterías alcalinas AA	\$ 15,545.00	191
TV201-1.9	◀ AHORRADOR Llave de lavabo electrónica de sensor a pared. De baterías alcalinas AA	\$ 15,545.00	191
TV-201-C	Llave de lavabo electrónica de sensor a pared. De corriente	\$ 16,379.00	191
TV201-C-1.9	◀ AHORRADOR Llave de lavabo electrónica de sensor a pared. De corriente	\$ 16,379.00	191
TV-203	Llave de lavabo electrónica de sensor a pared. De baterías alcalinas AA	\$ 15,545.00	192
TV203-1.9	◀ AHORRADOR Llave de lavabo electrónica de sensor a pared. De baterías alcalinas AA	\$ 15,545.00	192
TV-203-C	Llave de lavabo electrónica de sensor a pared. De corriente	\$ 16,379.00	192
TV203-C-1.9	◀ AHORRADOR Llave de lavabo electrónica de sensor a pared. De corriente	\$ 16,379.00	192
TV-296	Argos. Llave de lavabo electrónica de sensor. De baterías alcalinas AA	\$ 14,221.00	201
TV296-1.9	◀ AHORRADOR Argos. Llave de lavabo electrónica de sensor. De baterías alcalinas AA	\$ 14,221.00	201
TV-296-C	Argos. Llave de lavabo electrónica de sensor. De corriente	\$ 14,982.00	201

ÍNDICE ALFANUMÉRICO

MODELO	DESCRIPCIÓN	PRECIO	PÁGINA
TV296-C-1.9	◀ AHORRADOR Argos. Llave de lavabo electrónica de sensor. De corriente	\$ 14,982.00	201
TV-297	Alfa. Llave de lavabo electrónica de sensor. De baterías alcalinas AA	\$ 15,545.00	201
TV297-1.9	◀ AHORRADOR Alfa. Llave de lavabo electrónica de sensor. De baterías alcalinas AA	\$ 15,545.00	201
TV-297-C	Alfa. Llave de lavabo electrónica de sensor. De corriente	\$ 16,379.00	201
TV297-C-1.9	◀ AHORRADOR Alfa. Llave de lavabo electrónica de sensor. De corriente	\$ 16,379.00	201
TV-298	Omega. Llave de lavabo electrónica de sensor. De baterías alcalinas AA	\$ 15,545.00	202
TV298-1.9	◀ AHORRADOR Omega. Llave de lavabo electrónica de sensor. De baterías alcalinas AA	\$ 15,545.00	202
TV-298-C	Omega. Llave de lavabo electrónica de sensor. De corriente	\$ 16,379.00	202
TV298-C-1.9	◀ AHORRADOR Omega. Llave de lavabo electrónica de sensor. De corriente	\$ 16,379.00	202
TV-302	Líquida. Llave de lavabo electrónica de sensor. De baterías alcalinas AA	\$ 15,545.00	203
TV302-1.5	◀ AHORRADOR Líquida. Llave de lavabo electrónica de sensor. De baterías alcalinas AA	\$ 15,545.00	203
TV-302-C	Líquida. Llave de lavabo electrónica de sensor. De corriente	\$ 16,379.00	203
TV302-C-1.5	◀ AHORRADOR Líquida. Llave de lavabo electrónica de sensor. De corriente	\$ 16,379.00	203
TV-304	Forza. Llave de lavabo electrónica de sensor. De baterías alcalinas AA	\$ 14,221.00	204
TV304-1.5	◀ AHORRADOR Forza. Llave de lavabo electrónica de sensor. De baterías alcalinas AA	\$ 14,221.00	204
TV-304-C	Forza. Llave de lavabo electrónica de sensor. De corriente	\$ 14,982.00	204
TV304-C-1.5	◀ AHORRADOR Forza. Llave de lavabo electrónica de sensor. De corriente	\$ 14,982.00	204
TV-305	Llave de lavabo electrónica de sensor. De baterías alcalinas AA	\$ 12,087.00	204
TZF NAO	◀ AHORRADOR Taza para fluxómetro, elongada, trampa expuesta	\$ 5,165.00	244
TZF NAO P	◀ AHORRADOR Taza para fluxómetro a pared. Trampa semi oculta	\$ 5,580.00	246
TZF NAO17	◀ AHORRADOR Taza para fluxómetro, elongada, trampa expuesta. Altura confortable	\$ 5,165.00	244
V.D.1176	Válvula de drenaje antirretorno. Para tubo de albañal	\$ 9,143.00	189
V.D.1176-6	Válvula de drenaje antirretorno. Para tubo de PVC sanitario de 6"	\$ 9,143.00	189
VCG-2	Llave de hospital con cuello de ganso giratorio manija corta	\$ 4,040.00	193
VCG-2T	Llave de hospital con cuello de ganso giratorio. Maneral Tritón	\$ 4,040.00	193
VCG2-1.9	◀ AHORRADOR Llave de hospital con cuello de ganso giratorio manija corta	\$ 4,040.00	185
WC AUSTRAL	◀ AHORRADOR Inodoro, taza y tanque elongado compacto. Trampa expuesta	\$ 3,969.00	231
WC AUSTRAL P	◀ AHORRADOR Inodoro, taza y tanque elongado compacto. Trampa expuesta	\$ 3,969.00	232
WC BOLMEN16	◀ AHORRADOR Taza elongada y trampa oculta de altura confortable	\$ 5,555.00	233
WC BOLMEN16 M	◀ AHORRADOR Taza elongada y trampa oculta de altura confortable. Color marfil	\$ 5,555.00	233
WC DRAKAR16	◀ AHORRADOR Inodoro, taza y tanque elongado. Trampa expuesta	\$ 4,545.00	234
WC MIURA16	◀ AHORRADOR Inodoro, taza y tanque Elongado. Trampa oculta	\$ 9,258.00	230
WC MIURA16 TCC	◀ AHORRADOR Inodoro, taza y tanque elongado. Tecnología Cero Contacto	\$ 13,357.00	229
WC MURANO	◀ AHORRADOR Inodoro, taza y tanque elongado. Trampa oculta	\$ 10,662.00	227
WC OLIMPIA	◀ AHORRADOR Inodoro, taza y tanque redondo. Trampa expuesta	\$ 4,055.00	235
WC OLIMPIA M	◀ AHORRADOR Inodoro, taza y tanque redondo. Trampa expuesta. Color marfil	\$ 4,055.00	235
WC OPTION	◀ AHORRADOR Inodoro, taza y tanque elongado compacto. Trampa expuesta	\$ 3,879.00	236
WC OPTION P	◀ NUEVO Inodoro, taza y tanque elongado compacto. Palanca accionadora	\$ 3,879.00	237
WC RÓDANO16	◀ AHORRADOR Inodoro, taza y tanque elongado. Trampa expuesta	\$ 5,555.00	238
WC RÓDANO16 M	◀ AHORRADOR Inodoro, taza y tanque elongado. Trampa expuesta. Color marfil	\$ 5,555.00	238
WC SUSTENTA	◀ NUEVO Inodoro, taza y tanque elongado. Trampa expuesta. Descarga 2.5 LPD	\$ 4,439.00	239

ACABADOS

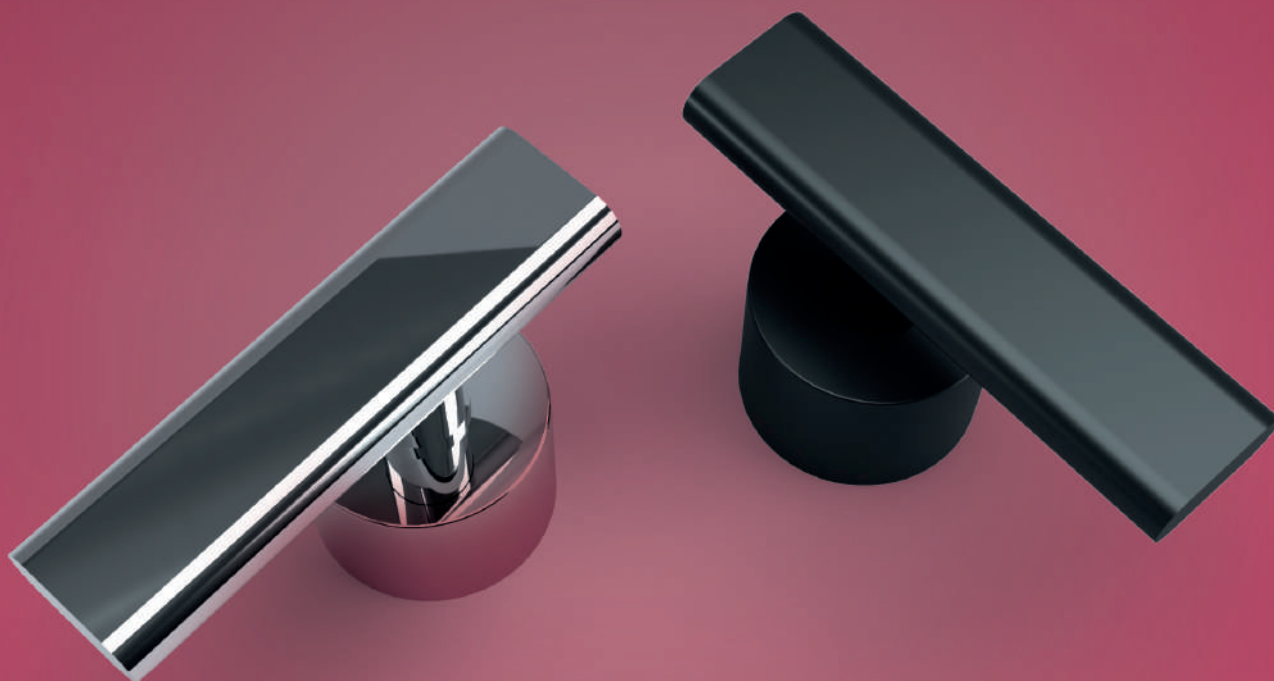

CR

Cromo



EB

Ébano

MANERALES



Redondos.



Cuadrados.



Cruceta.



Palanca.



Visite nuestra página web para consultar y descargar fichas técnicas e instructivos de instalación.
helvex.com     



HELVEX[®]

Garantía de Calidad



Garantía Helvex en acabado cromo de 10 años
y resto de acabados 2 años.

MANERALES

FLAIR

C-5

Acrílico transparente

\$ 1,371.00

Juego de manerales grandes.



Dimensiones:
vista frontal

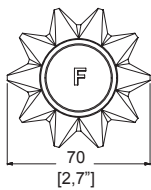

Dimensiones:
vista lateral

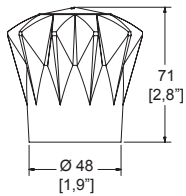

Cuerpo de latón.
Acrílico transparente.

TRITÓN

C-12

Cromo

\$ 1,390.00

Juego de manerales grandes.



Dimensiones:
vista frontal

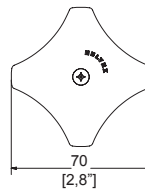

Dimensiones:
vista lateral

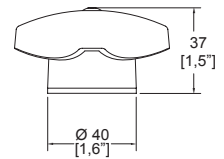

Acabado.



CAPRI

C-14

Cromo

\$ 1,551.00

Juego de manerales grandes.



Dimensiones:
vista frontal

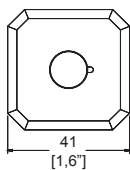

Dimensiones:
vista lateral

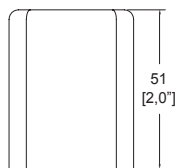

Acabado.



RIVOLI

C-16

Cromo

\$ 1,551.00

Juego de manerales grandes.



Dimensiones:
vista frontal

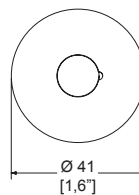

Dimensiones:
vista lateral

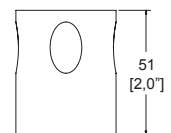

Acabado.



ANDROS

C-20

Cromo

\$ 1,561.00

Juego de manerales grandes.



Dimensiones:
vista frontal

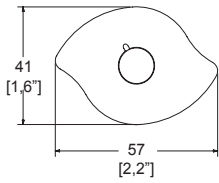

Dimensiones:
vista lateral

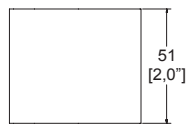

Acabado.

CR

TRÍPOLI

C-35

Cromo

\$ 1,551.00

Juego de manerales grandes.



Dimensiones:
vista frontal

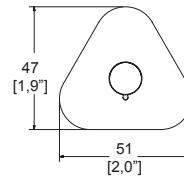

Dimensiones:
vista lateral

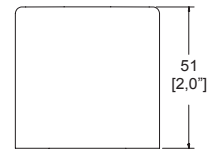

Acabado.

CR

ANTIQUA

C-37

Cromo

\$ 2,467.00

Juego de manerales grandes.



Dimensiones:
vista frontal

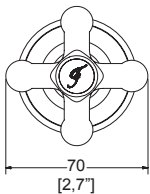

Dimensiones:
vista lateral

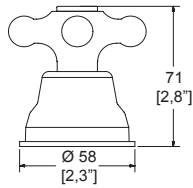

Incluye chapetones.

CR

ANTARES

C-44

Cromo

\$ 1,447.00

Juego de manerales grandes.



Dimensiones:
vista frontal

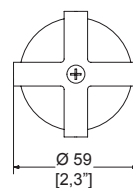

Dimensiones:
vista lateral

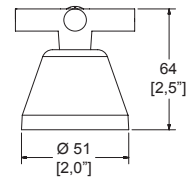

Incluye chapetones.

CR

MANERALES

ALBATROS

C-45

Cromo

\$ 1,447.00

Juego de manerales grandes.



Dimensiones:
vista frontal

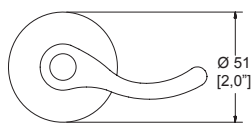

Dimensiones:
vista lateral

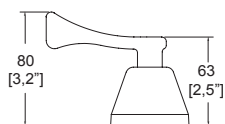

Incluye chapetones.

CR

ANTEA

C-46

Cromo

\$ 1,017.00

Juego de manerales grandes.



Dimensiones:
vista frontal

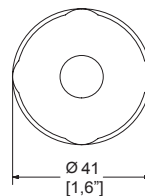

Dimensiones:
vista lateral

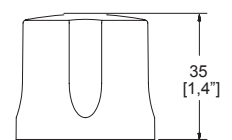

Acabado.

CR

ÁTICA

C-59

Cromo

\$ 1,447.00

Juego de manerales grandes.



Dimensiones:
vista frontal

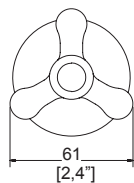

Dimensiones:
vista lateral

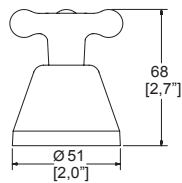

Incluye chapetones.

CR

NUVA

C-62

Cromo

\$ 2,862.00

Juego de manerales grandes.



Dimensiones:
vista frontal

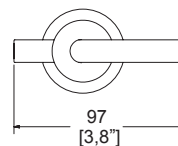

Dimensiones:
vista lateral

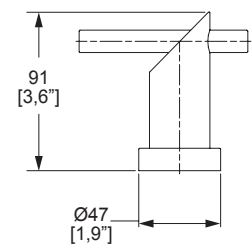

Incluye chapetones.

CR

NUVA

C-65

Cromo

\$ 2,862.00

Juego de manerales grandes.



Dimensiones:
vista frontal

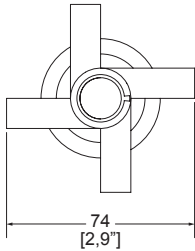

Dimensiones:
vista lateral

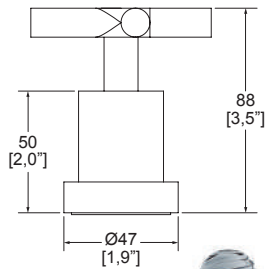

CR

Incluye chapetones.

PRIMMA

C-67

Cromo

\$ 1,504.00

Juego de manerales grandes.



Dimensiones:
vista frontal

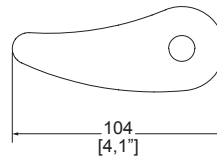

Dimensiones:
vista lateral

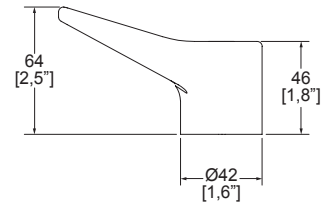

CR

Acabado.

KÚBICA

C-69

Cromo

\$ 2,982.00

Juego de manerales grandes.

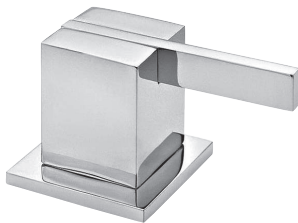

Dimensiones:
vista frontal

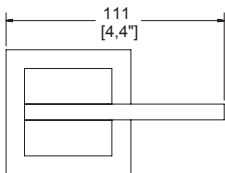

Dimensiones:
vista lateral

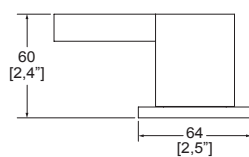

CR

Incluye chapetones.

PREMIER

C-70

Cromo

\$ 2,482.00

Juego de manerales grandes.



Dimensiones:
vista frontal

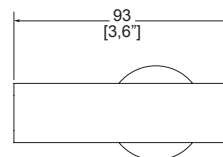

Dimensiones:
vista lateral

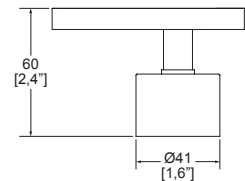

CR

Acabado.

MANERALES

PREMIER

C-70-EB

Ébano

\$ 2,853.00

Juego de manerales grandes.



Dimensiones:
vista frontal

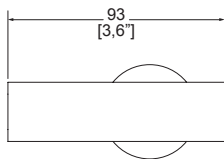

Dimensiones:
vista lateral

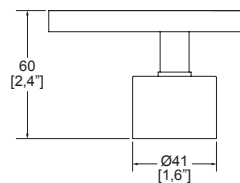

Incluye chapetones.



EB

KONOS

C-73

Cromo

\$ 2,482.00

Juego de manerales grandes.



Dimensiones:
vista frontal

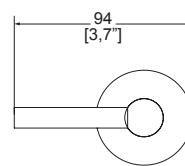

Dimensiones:
vista lateral

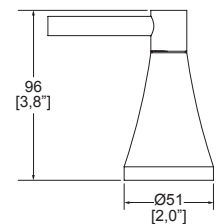

Acabado.



CR

TH-100

Cromo

\$ 773.00

Maneral central.



Dimensiones:
vista frontal

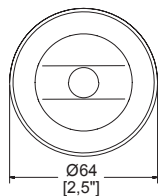

Dimensiones:
vista lateral

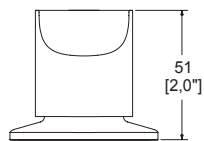

Incluye chapetón.



CR

TH-101

Cromo

\$ 1,114.00

Maneral central.



Dimensiones:
vista frontal

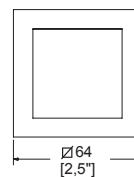

Dimensiones:
vista lateral

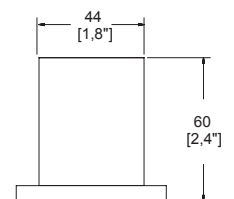

Incluye chapetón.



CR

ACABADOS

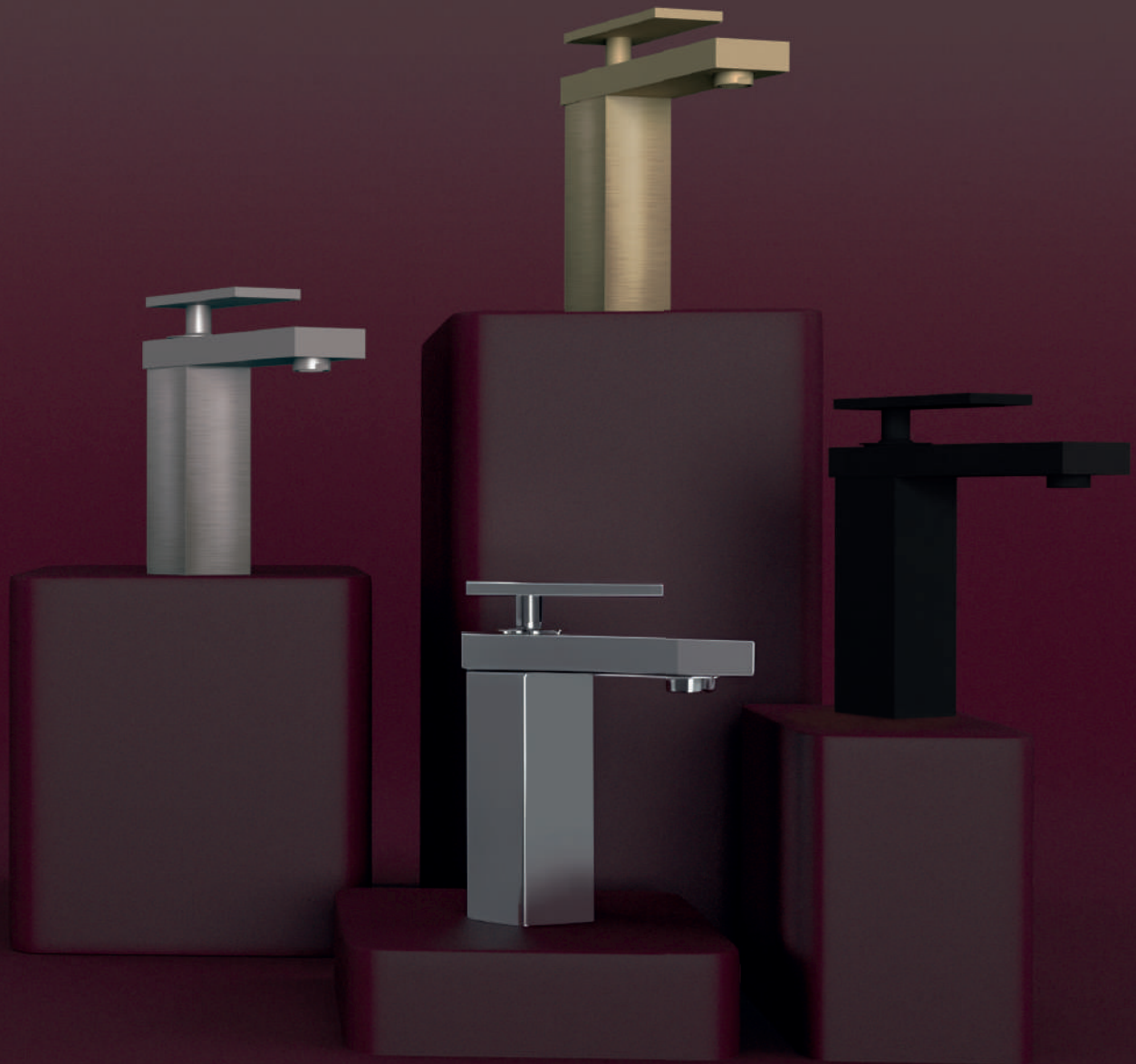

CR
Cromo



EB
Ébano



AU
Aura



DN
Duna



TN
Titanium

MEZCLADORAS Y MONOMANDOS



Mezcladoras 4".



Mezcladoras
de 8" a 12".



Monomandos
de lavabo.



Monomandos
a pared.



Visite nuestra página web para consultar y descargar
fichas técnicas e instructivos de instalación.
helvex.com     

MEZCLADORAS Y MONOMANDOS



Cartucho de disco de cerámico que garantiza un funcionamiento suave y un rendimiento duradero.

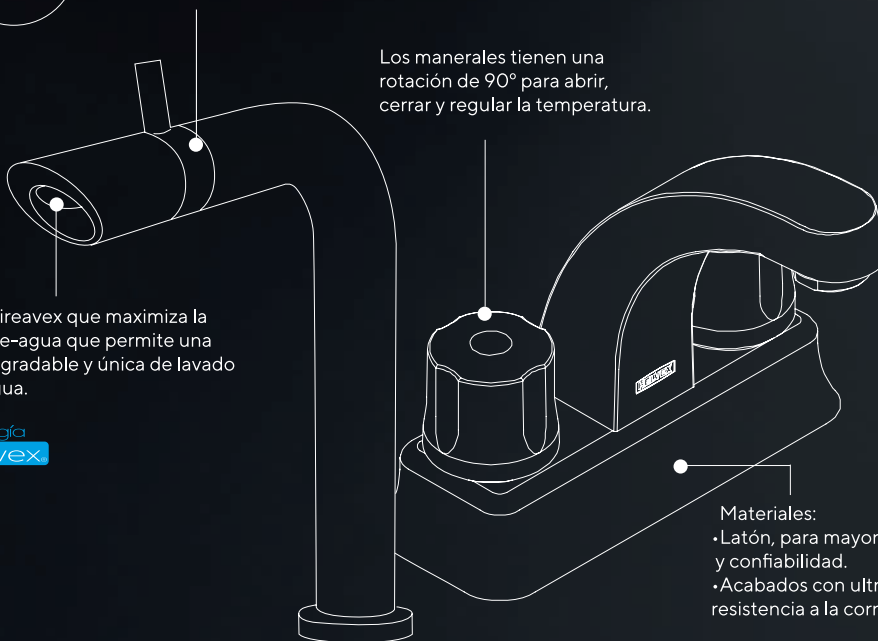

Los manerales tienen una rotación de 90° para abrir, cerrar y regular la temperatura.

Tecnología Aireavex que maximiza la mezcla de aire-agua que permite una experiencia agradable y única de lavado ahorrando agua.



Materiales:
• Latón, para mayor durabilidad y confiabilidad.
• Acabados con ultra alta resistencia a la corrosión.



Productos con uso eficiente de agua.

NMX

NMX-C-415-ONNCC-2015 "Industria de la Construcción - Válvulas y Grifos para Agua - Especificaciones y Métodos de ensayo".



Garantía Helvex en acabado cromo de 10 años y resto de acabados 2 años.

Fácil instalación y mantenimiento.

*Sólo aplica con productos Ecolvex:
MEP2006-1.9, MI01-S/C-1.9, MI02-S/C-1.9, E907-1.9, EP99-1.9, E928-1.9, E929-1.9, y EP3003-1.9

TIPOS DE CONTRAS



CONTRA DE PUSH

Presione **LA TAPA** para cerrar la contra y vuelva a **PRESIONAR** para abrirla y dejar drenar **EL AGUA**



CONTRA DE HONGO

El agua drenará alrededor de **LA TAPA**



CONTRA DE REJILLA

El agua drenará a través de **LA REJILLA**

HELVEX

Garantía de Calidad

MEZCLADORAS 4" INCLUYEN MANERALES

ANTARES

HM-14

Cromo

\$ 5,130.00

Mezcladora de lavabo 4".
Incluye contra de rejilla.



Dimensiones:
vista frontal

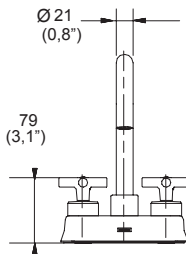

Dimensiones:
vista lateral

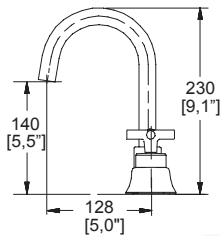

Incluye inserto para usarse con lavabos sin rebosadero.
Presión mínima requerida 0.25 kg/cm².

CR

ALBATROS

HM-17

Cromo

\$ 4,956.00

Mezcladora de lavabo 4".
Incluye contra de rejilla.



Dimensiones:
vista frontal

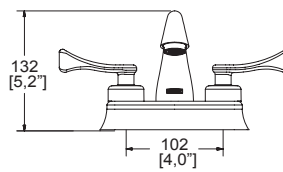

Dimensiones:
vista lateral

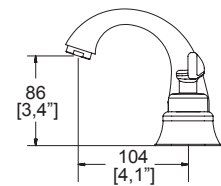

Incluye inserto para usarse con lavabos sin rebosadero.
Presión mínima requerida 0.25 kg/cm².

CR

ANTEA

HM-18

Cromo

\$ 4,894.00

Mezcladora de lavabo 4".
Incluye contra de rejilla.



Dimensiones:
vista frontal

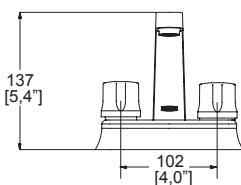

Dimensiones:
vista lateral

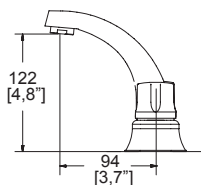

Incluye inserto para usarse con lavabos sin rebosadero.
Presión mínima requerida 0.25 kg/cm².

CR

ÁTICA

HM-21

Cromo

\$ 5,130.00

Mezcladora de lavabo 4".
Incluye contra de rejilla.



Dimensiones:
vista frontal

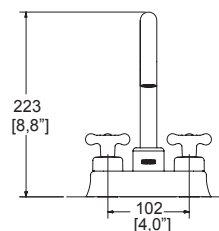

Dimensiones:
vista lateral

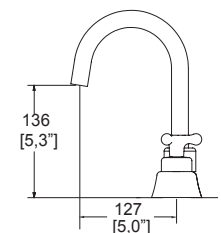

Incluye inserto para usarse con lavabos sin rebosadero.
Presión mínima requerida 0.25 kg/cm².

CR

ACAYA

HM-22

Cromo

\$ 4,894.00

Mezcladora de lavabo 4".
Incluye contra de rejilla.



Dimensiones:
vista frontal

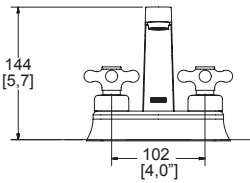

Dimensiones:
vista lateral

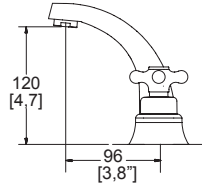

Incluye inserto para usarse con lavabos sin rebosadero.
Presión mínima requerida 0.25 kg/cm².



CR

ELITE

MI-01-S/C

Cromo

\$ 3,577.00

Mezcladora de lavabo 4".
No incluye contra.



Modelo ahorrador
MI01-S/C-1.9



Dimensiones:
vista frontal

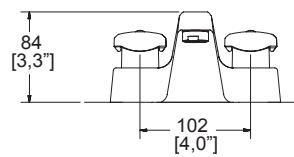

Dimensiones:
vista lateral

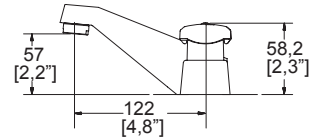

Presión mínima requerida 0.25 kg/cm².

NMX NMX-C-415-ONNCCE-2015



CR

PRIMMA

MI-02-S/C

Cromo

\$ 4,051.00

Mezcladora de lavabo 4".
No incluye contra.



Dimensiones:
vista frontal

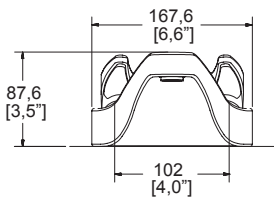

Dimensiones:
vista lateral

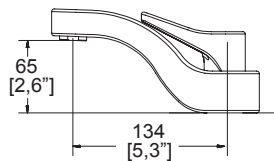

Presión mínima requerida 0.25 kg/cm².



CR



MEZCLADORAS 8" a 12" INCLUYEN MANERALES

IGUAZÚ MEP-2004

Cromo

\$ 6,436.00

Mezcladora de lavabo
8" a 12".
Incluye contra de push.



Dimensiones:
vista frontal

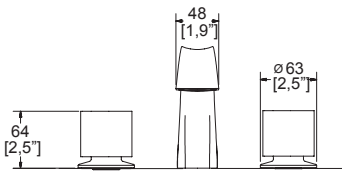

Dimensiones:
vista lateral

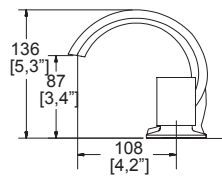

Incluye inserto para usarse con lavabos sin rebosadero.
Presión mínima requerida 0.25 kg/cm².

CR

NUVA MEP-2006

Cromo

\$ 10,394.00

Mezcladora de lavabo
8" a 12".
Incluye contra de push.

 Modelo ahorrador
MEP2006-1.9



Dimensiones:
vista frontal

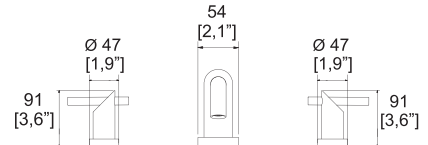

Dimensiones:
vista lateral

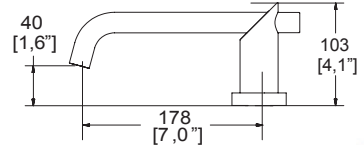

Incluye inserto para usarse con lavabos sin rebosadero.
Presión mínima requerida 0.25 kg/cm².

NMX NMX-C-415-ONNCCE-2015

CR

PREMIER MEP-2115

Cromo

\$ 11,225.00

Mezcladora de lavabo
8" a 12".
Incluye contra de push.



Dimensiones:
vista frontal

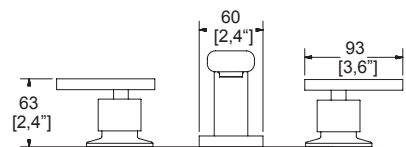

Dimensiones:
vista lateral

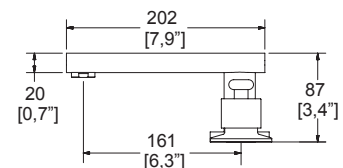

Incluye inserto para usarse con lavabos sin rebosadero.
Presión mínima requerida 0.25 kg/cm².

CR



VÉRTIKA
MP-1000

Cromo

\$ 11,753.00

Mezcladora de lavabo
8" a 12".
Incluye contra de push.

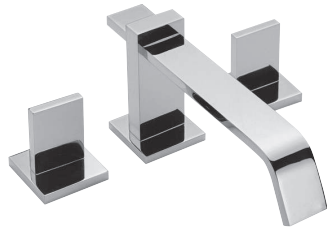

CR

Incluye inserto para usarse con lavabos sin rebosadero.
Presión mínima requerida 1.00 kg/cm².
Consumo de agua mínimo de 6 L/min.

VÉRTIKA
MP-1000-DN

Duna

\$ 13,516.00

Mezcladora de lavabo
8" a 12".
Incluye contra de push
Duna.

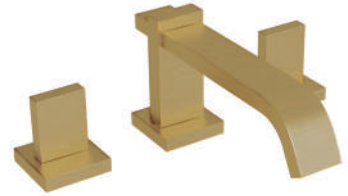

DN

Incluye inserto para usarse con lavabos sin rebosadero.
Presión mínima requerida 1.00 kg/cm².
Consumo de agua mínimo de 6 L/min.

VÉRTIKA
MP-1000-TN

Titanium

\$ 13,516.00

Mezcladora de lavabo
8" a 12".
Incluye contra de push
Titanium.



TN

Incluye inserto para usarse con lavabos sin rebosadero.
Presión mínima requerida 1.00 kg/cm².
Consumo de agua mínimo de 6 L/min.

Dimensiones:
vista frontal

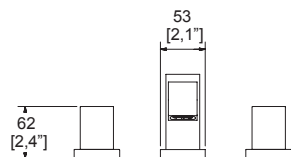

Dimensiones:
vista lateral

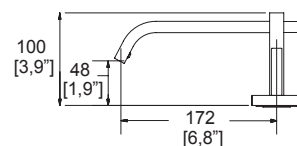

MEZCLADORAS 8" a 12" INCLUYEN MANERALES

CLÁSICA M-1005

Cromo

\$7,904.00

Mezcladora de lavabo
8" a 12".
Incluye contra de push.



Dimensiones:
vista frontal

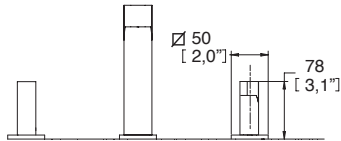

Dimensiones:
vista lateral

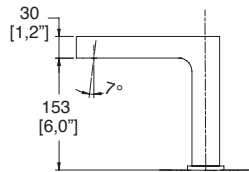

Incluye inserto para usarse con lavabos sin rebosadero.
Presión mínima requerida 0.25 kg/cm².



NAUTILIA M-1006

Cromo

\$11,081.00

Mezcladora de lavabo
8" a 12".
Incluye contra de push.



Dimensiones:
vista frontal

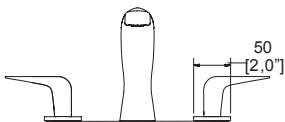

Dimensiones:
vista lateral

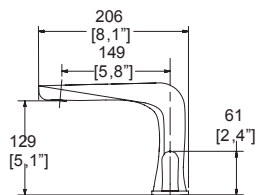

Incluye inserto para usarse con lavabos sin rebosadero.
Presión mínima requerida 0.25 kg/cm².



KONOS

E-916

Cromo

\$ 7,030.00

Monomando de lavabo.
Incluye contra de push.



Dimensiones:
vista frontal

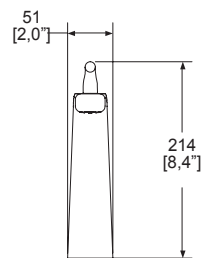

Dimensiones:
vista lateral

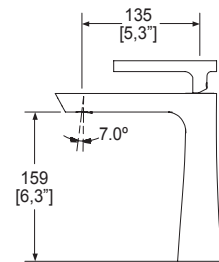

Incluye inserto para usarse con lavabos sin rebosadero.
Presión mínima requerida 0.40 kg/cm².



CR

Todos nuestros monomandos
cuentan con Tecnología Aireavex



MONOMANDOS DE LAVABO

CLÁSICA

E-917

Cromo

\$ 6,043.00

Monomando de lavabo.
Incluye contra de push.



CR

Maneral reforzado.
Incluye inserto para usarse con lavabos sin rebosadero.
Presión mínima requerida 0.40 kg/cm².

CLÁSICA

E-917-AU

Aura

\$ 6,949.00

Monomando de lavabo.
Incluye contra de push
Aura.



AU

Maneral reforzado.
Incluye inserto para usarse con lavabos sin rebosadero.
Presión mínima requerida 0.40 kg/cm².

CLÁSICA

E-917-OB

Obsidiana

\$ 6,949.00

Monomando de lavabo.
Incluye contra de push
Obsidiana.



OB

Maneral reforzado.
Incluye inserto para usarse con lavabos sin rebosadero.
Presión mínima requerida 0.40 kg/cm².



Dimensiones:
vista frontal

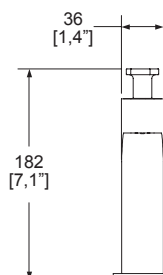

Dimensiones:
vista lateral

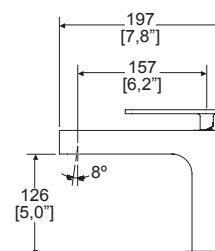

Todos nuestros monomandos
cuentan con Tecnología Aireavex

CENTURY

E-928

Cromo

\$ 5,269.00

Monomando de lavabo.
Incluye contra de rejilla.

 **Modelo ahorrador**
E928-1.9



Dimensiones:
vista frontal

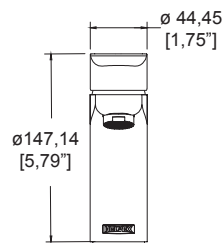

Dimensiones:
vista lateral

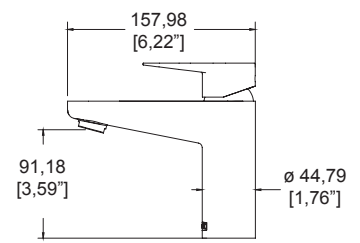

Incluye inserto para usarse con lavabos sin rebosadero.
Presión mínima requerida 0.25 kg/cm².

NMX NMX-C-415-ONNCE-2015



CENTURY alto

E-943

Cromo

\$ 6,898.00

Monomando de lavabo.
Incluye contra de rejilla.



Dimensiones:
vista frontal

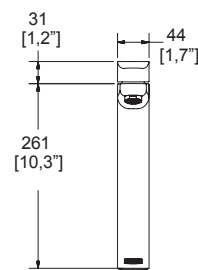

Dimensiones:
vista lateral

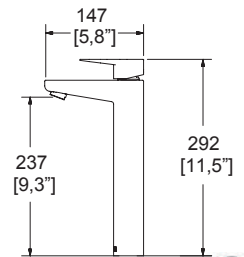

Incluye inserto para usarse con lavabos sin rebosadero.
Presión mínima requerida 0.60 kg/cm².



Todos nuestros monomandos cuentan con Tecnología Aireavex



MONOMANDOS DE LAVABO

ÁLIKA

E-920

Cromo

\$ 8,447.00

Monomando de lavabo.
Incluye contra de push.



Dimensiones:
vista frontal

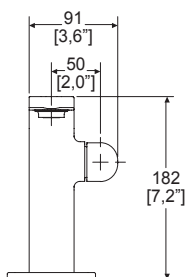

Dimensiones:
vista lateral

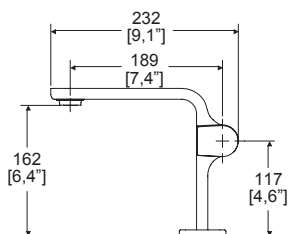

Incluye inserto para usarse con lavabos sin rebosadero.
Presión mínima requerida 0.60 kg/cm².

CR

ÁLIKA alto

E-921

Cromo

\$ 10,586.00

Monomando de lavabo.
Incluye contra de push.



Dimensiones:
vista frontal

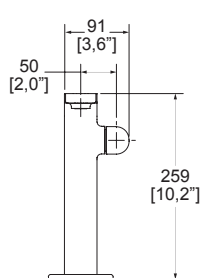

Dimensiones:
vista lateral

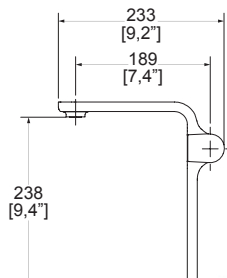

Incluye inserto para usarse con lavabos sin rebosadero.
Presión mínima requerida 0.60 kg/cm².

CR



Todos nuestros monomandos
cuentan con Tecnología Aireavex



BAMBOO

E-922

Cromo

\$ 8,038.00

Monomando de lavabo.
Incluye contra de push.



CR

Incluye inserto para usarse con lavabos sin rebosadero.
Presión mínima requerida 0.80 kg/cm².
Con un solo movimiento controlas flujo y temperatura.

BAMBOO

E-922-EB

Ébano

\$ 9,243.00

Monomando de lavabo.
Incluye contra de push.
Ébano.



EB

Incluye inserto para usarse con lavabos sin rebosadero.
Presión mínima requerida 0.80 kg/cm².
Con un solo movimiento controlas flujo y temperatura.

Dimensiones:
vista frontal

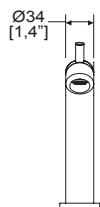

Dimensiones:
vista lateral

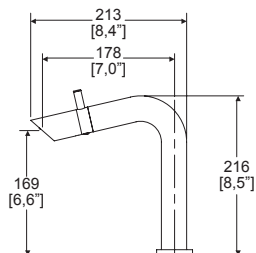

BAMBOO

E-923

Cromo

\$ 9,387.00

Monomando de lavabo.
Incluye contra de push.



CR

Incluye inserto para usarse con lavabos sin rebosadero.
Presión mínima requerida 0.80 kg/cm².
Con un solo movimiento controlas flujo y temperatura.

BAMBOO

E-923-EB

Ébano

\$ 10,796.00

Monomando de lavabo.
Incluye contra de push.
Ébano.



EB

Incluye inserto para usarse con lavabos sin rebosadero.
Presión mínima requerida 0.80 kg/cm².
Con un solo movimiento controlas flujo y temperatura.

Dimensiones:
vista frontal



Dimensiones:
vista lateral

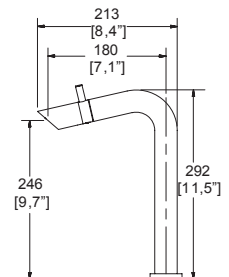

Todos nuestros monomandos
cuentan con Tecnología Aireavex





SCALA
E-948

Cromo

\$ 7,670.00

Monomando de lavabo.
Incluye contra de push.

Maneral
de instalación
independiente

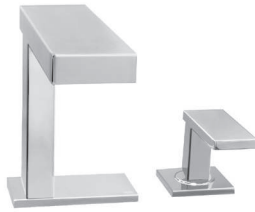

CR

Incluye inserto para usarse con lavabos sin rebosadero.
Presión mínima requerida 0.60 kg/cm².

SCALA alto
E-949

Cromo

\$ 8,922.00

Monomando de lavabo.
Incluye contra de push.

Maneral
de instalación
independiente



CR

Incluye inserto para usarse con lavabos sin rebosadero.
Presión mínima requerida 0.60 kg/cm².

SCALA
E-948-EB

Ébano

\$ 8,821.00

Monomando de lavabo.
Incluye contra de push ébano.

Maneral
de instalación
independiente



EB

Incluye inserto para usarse con lavabos sin rebosadero.
Presión mínima requerida 0.60 kg/cm².

SCALA alto
E-949-EB

Ébano

\$ 10,259.00

Monomando de lavabo.
Incluye contra de push ébano.

Maneral
de instalación
independiente



EB

Incluye inserto para usarse con lavabos sin rebosadero.
Presión mínima requerida 0.60 kg/cm².

Dimensiones:
vista frontal

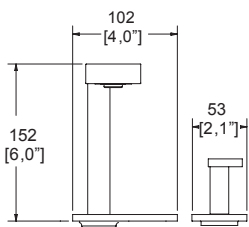

Dimensiones:
vista lateral

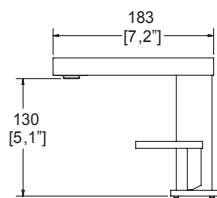

Dimensiones:
vista frontal

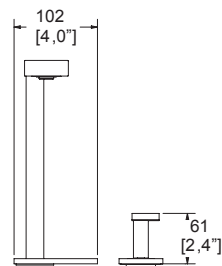

Dimensiones:
vista lateral

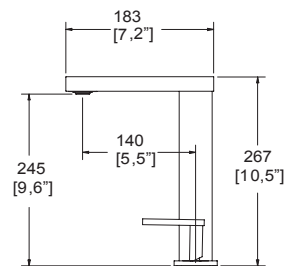

Todos nuestros monomandos
cuentan con Tecnología Aireavex



MONOMANDOS DE LAVABO

INDUS

E-950-EB

Ébano

\$ 9,243.00

Monomando de lavabo.
Incluye contra de push ébano.



Dimensiones:
vista frontal

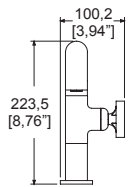

Dimensiones:
vista lateral

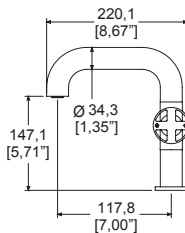

Incluye inserto para usarse con lavabos sin rebosadero.
Presión mínima requerida 0.60 kg/cm².

EB

INDUS alto

E-951-EB

Ébano

\$ 10,796.00

Monomando de lavabo.
Incluye contra de push ébano.



Dimensiones:
vista frontal

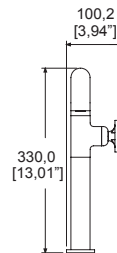

Dimensiones:
vista lateral

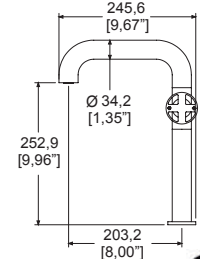

Incluye inserto para usarse con lavabos sin rebosadero.
Presión mínima requerida 0.60 kg/cm².

EB

VÉRTIKA

EP-905

Cromo

\$ 9,308.00

Monomando de lavabo.
Incluye contra de push.



Dimensiones:
vista frontal

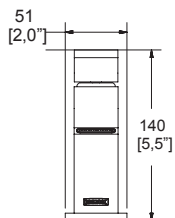

Dimensiones:
vista lateral

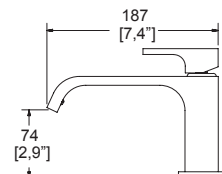

Incluye inserto para usarse con lavabos sin rebosadero.
Presión mínima requerida 0.60 kg/cm².

CR



Todos nuestros monomandos
cuentan con Tecnología Aireavex



NUVA
EP-99

Cromo

\$ 9,674.00

Monomando de lavabo.
Incluye contra de push.

 **Modelo ahorrador**
EP99-1.9



Dimensiones:
vista frontal

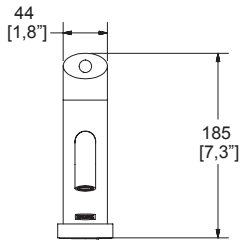

Dimensiones:
vista lateral

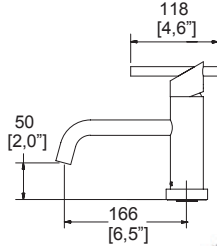

Incluye inserto para usarse con lavabos sin rebosadero.
Presión mínima requerida 0.25 kg/cm².

NMX NMX-C-415-ONNCE-2015

CR

NUVA mediano
EP-945

Cromo

\$ 11,655.00

Monomando de lavabo.
Incluye contra de push.



Dimensiones:
vista frontal

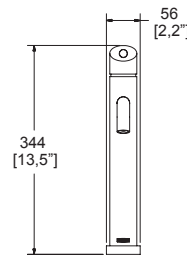

Dimensiones:
vista lateral

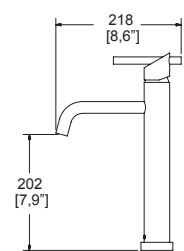

Incluye inserto para usarse con lavabos sin rebosadero.
Presión mínima requerida 0.25 kg/cm².

CR

NUVA alto
EP-947

Cromo

\$ 11,964.00

Monomando de lavabo.
Incluye contra de push.



Dimensiones:
vista frontal

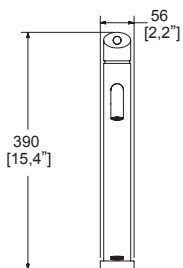

Dimensiones:
vista lateral

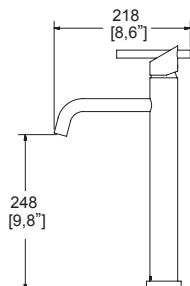

Incluye inserto para usarse con lavabos sin rebosadero.
Presión mínima requerida 0.25 kg/cm².

CR

Todos nuestros monomandos
cuentan con Tecnología Aireavex



MONOMANDOS DE LAVABO

PREMIER

EP-909

Cromo

\$ 7,099.00

Monomando de lavabo.
Incluye contra de push.



Incluye inserto para usarse con lavabos sin rebosadero.
Presión mínima requerida 0.60 kg/cm².



CR

PREMIER

EP-909-EB

Ébano

\$ 8,162.00

Monomando de lavabo.
Incluye contra de push ébano.



Incluye inserto para usarse con lavabos sin rebosadero.
Presión mínima requerida 0.60 kg/cm².



EB

Dimensiones:
vista frontal

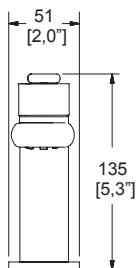

Dimensiones:
vista lateral

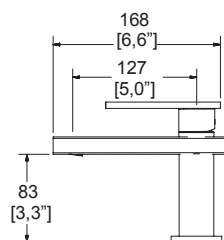

Todos nuestros monomandos
cuentan con Tecnología Aireavex





PREMIER alto
EP-938

Cromo

\$ 9,122.00

Monomando de lavabo.
Incluye contra de push.



CR

Incluye inserto para usarse con lavabos sin rebosadero.
Presión mínima requerida 0.70 kg/cm².

PREMIER alto
EP-938-EB

Ébano

\$ 10,489.00

Monomando de lavabo.
Incluye contra de push ébano.



EB

Incluye inserto para usarse con lavabos sin rebosadero.
Presión mínima requerida 0.70 kg/cm².

Dimensiones:
vista frontal

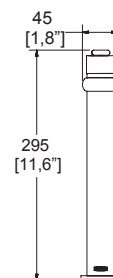

Dimensiones:
vista lateral

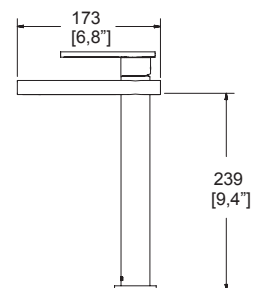

Todos nuestros monomandos
cuentan con Tecnología Aireavex



MONOMANDOS DE LAVABO

PREMIER II

E-941

Cromo

\$ 6,518.00

Monomando de lavabo.
Incluye contra de push.



Incluye inserto para usarse con lavabos sin rebosadero.
Presión mínima requerida 0.60 kg/cm².

CR

PREMIER II

E-941-EB

Ébano

\$ 7,497.00

Monomando de lavabo.
Incluye contra de push ébano.



Incluye inserto para usarse con lavabos sin rebosadero.
Presión mínima requerida 0.60 kg/cm².

EB

Dimensiones:
vista frontal

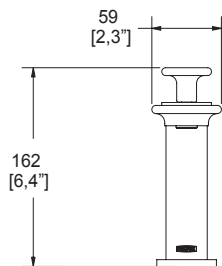

Dimensiones:
vista lateral

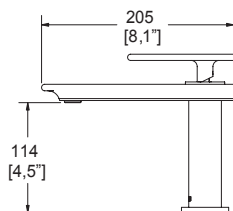

Todos nuestros monomandos
cuentan con Tecnología Aireavex



SQUADRA
E-929

Cromo

\$ 5,436.00

Monomando de lavabo.
Incluye contra de rejilla.

 **Modelo ahorrador**
E929-1.9

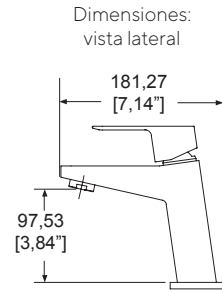
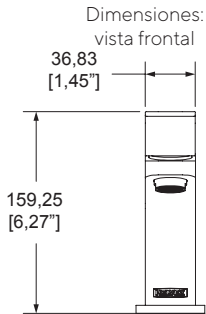

Incluye inserto para usarse con lavabos sin rebosadero.
Presión mínima requerida 0.40 kg/cm².

NMX NMX-C-415-ONNCCE-2015

CR

SQUADRA alto
E-937

Cromo

\$ 7,520.00

Monomando de lavabo.
Incluye contra de rejilla.

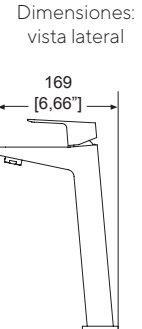
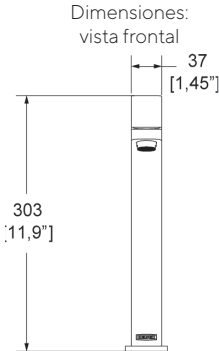

Presión mínima requerida 0.40 kg/cm².

CR

KÚBICA
EP-94

Cromo

\$ 10,161.00

Monomando de lavabo.
Incluye contra de push.

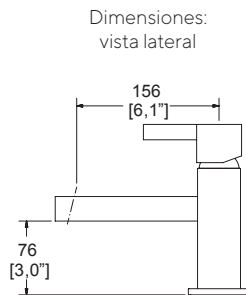
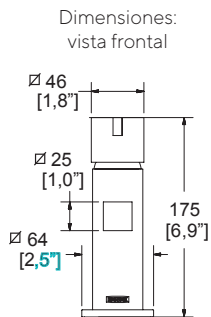

Incluye inserto para usarse con lavabos sin rebosadero.
Presión mínima requerida 0.25 kg/cm².

CR

NOVARA
E-930

Cromo

\$ 7,220.00

Monomando de lavabo.
Incluye contra de push.



**PRODUCTO PRÓXIMO A
DESCONTINUAR**

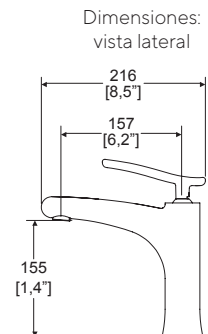
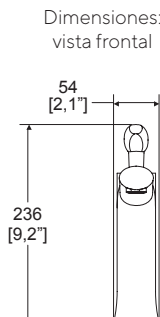

Incluye inserto para usarse con lavabos sin rebosadero.
Presión mínima requerida 0.25 kg/cm².

CR

Todos nuestros monomandos
cuentan con Tecnología Aireavex



MONOMANDOS DE LAVABO

NAUTILIA

E-924

Cromo

\$ 8,447.00

Monomando de lavabo.
Incluye contra de push.

Maneral
de instalación
independiente



Dimensiones:
vista frontal

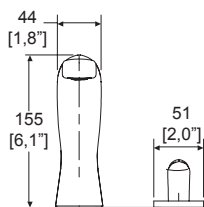

Dimensiones:
vista lateral

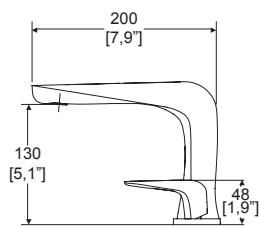

Incluye inserto para usarse con lavabos sin rebosadero.
Presión mínima requerida 0.70 kg/cm².

CR

NAUTILIA

E-925

Cromo

\$ 9,852.00

Monomando de lavabo.
Incluye contra de push.

Maneral
de instalación
independiente



Dimensiones:
vista frontal

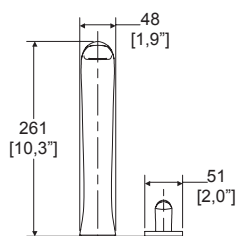

Dimensiones:
vista lateral

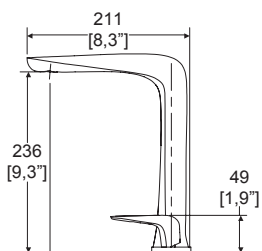

Incluye inserto para usarse con lavabos sin rebosadero.
Presión mínima requerida 0.70 kg/cm².

CR



Todos nuestros monomandos
cuentan con Tecnología Aireavex

EXPLORA

E-907

Cromo

\$ 5,561.00

Monomando de lavabo.
Incluye contra de rejilla.

 Modelo ahorrador
E907-1.9



CR

Incluye inserto para usarse con lavabos sin rebosadero.
Presión mínima requerida 0.25 kg/cm².

NMX NMX-C-415-ONNCCE-2015

EXPLORA

E-907-CE

Cromo

\$ 5,561.00

Monomando de lavabo.
Incluye contra de rejilla.

 Modelo ahorrador
E907-CE-6



CR

Incluye inserto para usarse con lavabos sin rebosadero.

Cartucho ecológico.

Ahorro de agua y energía.

Presión mínima recomendada 0.60 kg/cm².

EXPLORA

E-908

Cromo

\$ 5,158.00

Monomando de lavabo.
No incluye contra.



CR

Presión mínima requerida 0.25 kg/cm².

EXPLORA

E-908-CE

Cromo

\$ 5,158.00

Monomando de lavabo.
No incluye contra.



CR

Cartucho ecológico.

Ahorro de agua y energía.

Presión mínima recomendada 0.60 kg/cm².

Dimensiones:
vista frontal

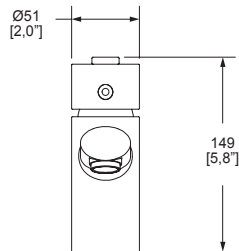

Dimensiones:
vista lateral

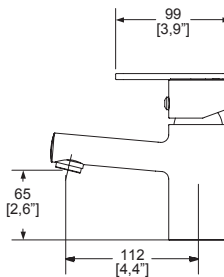

Todos nuestros monomandos
cuentan con Tecnología Aireavex

FUNCIONAMIENTO DEL CARTUCHO ECOLÓGICO

PARA LOS MODELOS
E-907-CE Y E-908-CE

1 Ahorro de agua

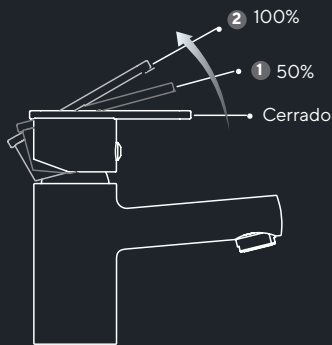

2 Ahorro de energía

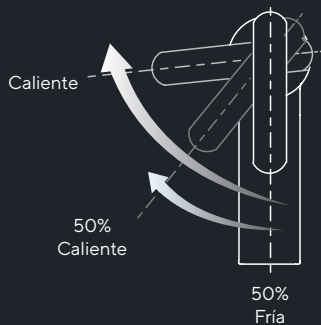

MÁXIMA mediano
EP-932

Cromo

\$ 7,304.00

Monomando de lavabo.
Incluye contra de push.



CR

Incluye inserto para usarse con lavabos sin rebosadero.
Presión mínima requerida 0.25 kg/cm².

MÁXIMA mediano
EP-932-EB

Ébano

\$ 8,400.00

Monomando de lavabo.
Incluye contra de push Ébano.



EB

Incluye inserto para usarse con lavabos sin rebosadero.
Presión mínima requerida 0.25 kg/cm².

MÁXIMA mediano
EP-932-DN

Duna

\$ 8,400.00

Monomando de lavabo.
Incluye contra de push
Duna.



DN

Incluye inserto para usarse con lavabos sin rebosadero.
Presión mínima requerida 0.25 kg/cm².

MÁXIMA mediano
EP-932-TN

Titanium

\$ 8,400.00

Monomando de lavabo.
Incluye contra de push
Titanium.



TN

Incluye inserto para usarse con lavabos sin rebosadero.
Presión mínima requerida 0.25 kg/cm².

Dimensiones:
vista frontal

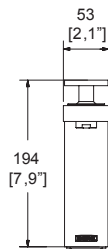

Dimensiones:
vista lateral

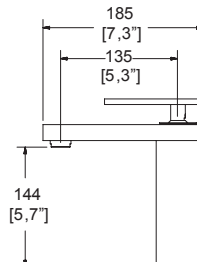

Todos nuestros monomandos
cuentan con Tecnología Aireavex

MONOMANDOS DE LAVABO

MÁXIMA alto EP-933

Cromo

\$ 8,652.00

Monomando de lavabo.
Incluye contra de push.



CR

Incluye inserto para usarse con lavabos sin rebosadero.
Presión mínima requerida 0.25 kg/cm².

MÁXIMA alto EP-933-EB

Ébano

\$ 9,950.00

Monomando de lavabo.
Incluye contra de push Ébano.



EB

Incluye inserto para usarse con lavabos sin rebosadero.
Presión mínima requerida 0.25 kg/cm².

MÁXIMA alto EP-933-DN

Duna

\$ 9,950.00

Monomando de lavabo.
Incluye contra de push
Duna.



DN

Incluye inserto para usarse con lavabos sin rebosadero.
Presión mínima requerida 0.25 kg/cm².

MÁXIMA alto EP-933-TN

Titanium

\$ 9,950.00

Monomando de lavabo.
Incluye contra de push
Titanium.



TN

Incluye inserto para usarse con lavabos sin rebosadero.
Presión mínima requerida 0.25 kg/cm².

Dimensiones:
vista frontal

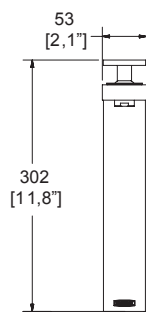

Dimensiones:
vista lateral

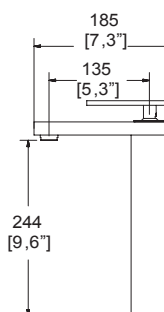

Todos nuestros monomandos
cuentan con Tecnología Aireavex



LAND

E-939

Cromo

\$ 6,043.00

Monomando de lavabo.
Incluye contra de push.



CR

Incluye inserto para usarse con lavabos sin rebosadero.
Presión mínima requerida 0.40 kg/cm².

LAND

E-939-EB

Ébano

\$ 6,949.00

Monomando de lavabo.
Incluye contra de push Ébano.



EB

Incluye inserto para usarse con lavabos sin rebosadero.
Presión mínima requerida 0.40 kg/cm².

Dimensiones:
vista frontal

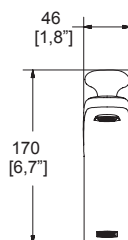

Dimensiones:
vista lateral

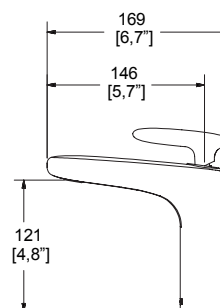

Todos nuestros monomandos cuentan con Tecnología Aireavex



MONOMANDOS DE LAVABO

ALBA

E-940

Cromo

\$ 8,038.00

Monomando de lavabo.
Incluye contra de push.



Dimensiones:
vista frontal

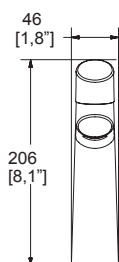

Dimensiones:
vista lateral

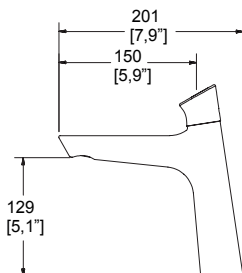

Incluye inserto para usarse con lavabos sin rebosadero.
Presión mínima requerida 0.40 kg/cm².

CR

LUSITANIA

LUS-100

Cromo

\$ 3,039.00

Monomando de lavabo.
No incluye contra.



Dimensiones:
vista frontal

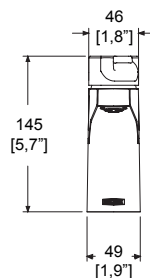

Dimensiones:
vista lateral

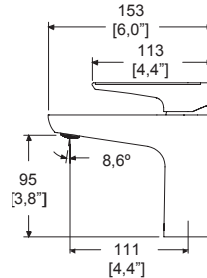

Maneral marcado con indicador de temperatura
frío o caliente.
Presión mínima requerida 0.25 kg/cm².

CR

LUSITANIA alto

LUS-101

Cromo

\$ 4,132.00

Monomando de lavabo.
No incluye contra.



Dimensiones:
vista frontal

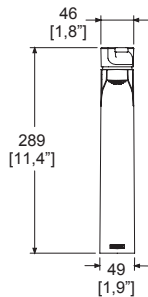

Dimensiones:
vista lateral

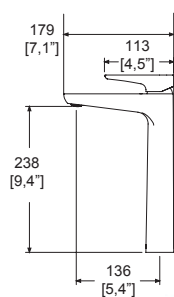

Maneral marcado con indicador de temperatura
frío o caliente.
Presión mínima requerida 0.25 kg/cm².

CR



Todos nuestros monomandos
cuentan con Tecnología Aireavex



PIAZZA
PIA-100

Cromo

\$ 3,039.00

Monomando de lavabo.
No incluye contra.



Maneral marcado con indicador de temperatura frío o caliente.
Presión mínima requerida 0.25 kg/cm².

CR

PIAZZA alto
PIA-101

Cromo

\$ 4,132.00

Monomando de lavabo.
No incluye contra.



Maneral marcado con indicador de temperatura frío o caliente.
Presión mínima requerida 0.25 kg/cm².

CR

PIAZZA
PIA-100-EB
Ébano



\$ 3,495.00

Monomando de lavabo.
No incluye contra.



Presión mínima requerida 0.25 kg/cm².

EB

PIAZZA alto
PIA-101-EB
Ébano



\$ 4,752.00

Monomando de lavabo.
No incluye contra.



Presión mínima requerida 0.25 kg/cm².

EB

Dimensiones:
vista frontal

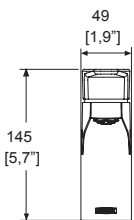

Dimensiones:
vista lateral

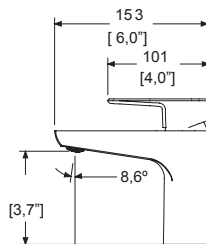

Dimensiones:
vista frontal

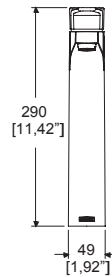

Dimensiones:
vista lateral

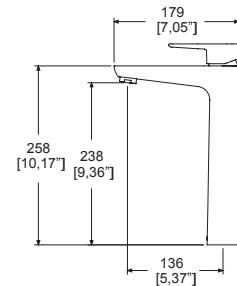

Todos nuestros monomandos cuentan con Tecnología Aireavex



PIURA

PIU-100

Cromo

\$ 10,795.00

Monomando de lavabo.
Incluye contra de push.



Dimensiones:
vista frontal

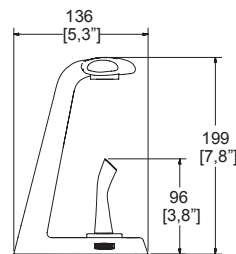

Dimensiones:
vista lateral

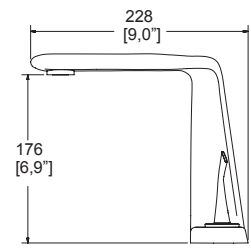

Incluye inserto para usarse con lavabos sin rebosadero.
Presión mínima requerida 0.60 kg/cm².



CR

PIURA alto

PIU-101

Cromo

\$ 13,597.00

Monomando de lavabo.
Incluye contra de push.

Maneral
de instalación
independiente



Dimensiones:
vista frontal

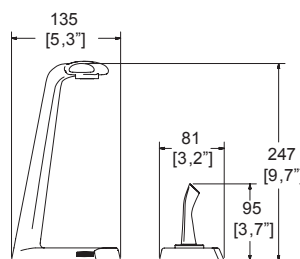

Dimensiones:
vista lateral

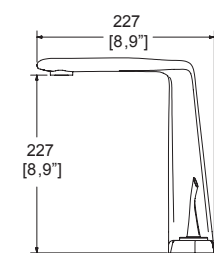

Incluye inserto para usarse con lavabos sin rebosadero.
Presión mínima requerida 0.60 kg/cm².



CR

Todos nuestros monomandos
cuentan con Tecnología Aireavex



MONOMANDOS DE LAVABO A PARED

NUVA EP-3003

Cromo

\$10,343.00

Monomando de lavabo a pared.
Incluye contra de push.

 Modelo ahorrador
EP3003-1.9



Dimensiones:
vista frontal

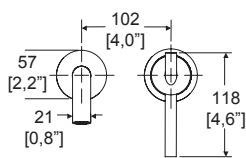

Dimensiones:
vista lateral

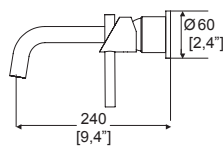

Incluye inserto para usarse con lavabos sin rebosadero.
Presión mínima requerida 0.25 kg/cm².



NMX NMX-C-415-ONNCE-2015

KÚBICA EP-3005

Cromo

\$12,308.00

Monomando de lavabo a pared.
Incluye contra de push.

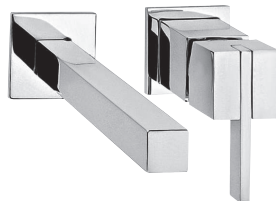

Dimensiones:
vista frontal

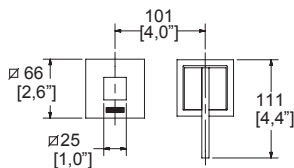

Dimensiones:
vista lateral

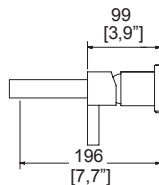

Incluye inserto para usarse con lavabos sin rebosadero.
Presión mínima requerida 0.25 kg/cm².



Todos nuestros monomandos
cuentan con Tecnología Aireavex



VÉRTIKA
EP-3007

Cromo

\$ 11,015.00

Monomando de lavabo a pared.
Incluye contra de push.



Incluye inserto para usarse con lavabos sin rebosadero.
Presión mínima requerida 1.00 kg/cm².
Consumo de agua: 5 L/min.

CR

VÉRTIKA
EP-3007-EB

Ébano

\$ 12,667.00

Monomando de lavabo a pared.
Incluye contra de push.
Ébano.



Incluye inserto para usarse con lavabos sin rebosadero.
Presión mínima requerida 1.00 kg/cm².
Consumo de agua: 5 L/min.

EB

VÉRTIKA
EP-3007-DN

Duna

\$ 12,667.00

Monomando de lavabo a pared.
Incluye contra de push.
Duna.



Incluye inserto para usarse con lavabos sin rebosadero.
Presión mínima requerida 1.00 kg/cm².
Consumo de agua: 5 L/min.

DN

VÉRTIKA
EP-3007-TN

Titanium

\$ 12,667.00

Monomando de lavabo a pared.
Incluye contra de push.
Titanium.



Incluye inserto para usarse con lavabos sin rebosadero.
Presión mínima requerida 1.00 kg/cm².
Consumo de agua: 5 L/min.

TN

Dimensiones:
vista frontal

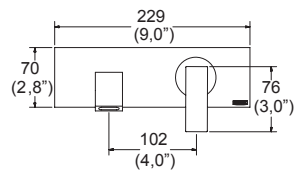

Dimensiones:
vista lateral

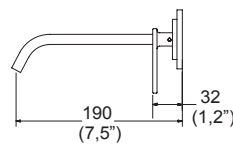

Todos nuestros monomandos cuentan con Tecnología Aireavex

Vértika Titanium. EP-3007-TN

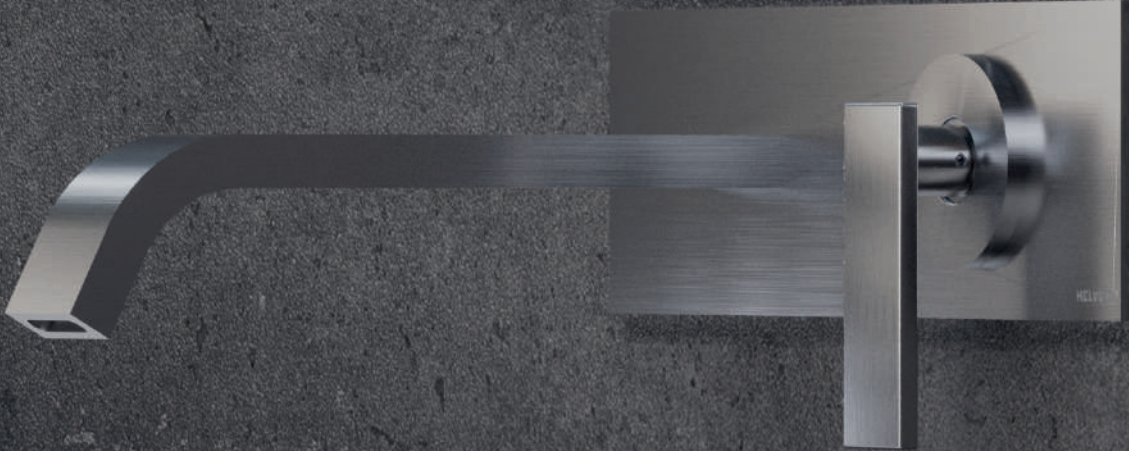

ACABADOS



CR

Cromo



EB

Ébano

CONTRAS Y COMPLEMENTOS PARA LAVABO



Céspedes.



Contras de rejilla.



Contras de hongo.



Contras de push.



Tubo de extensión.



Válvula de paso.

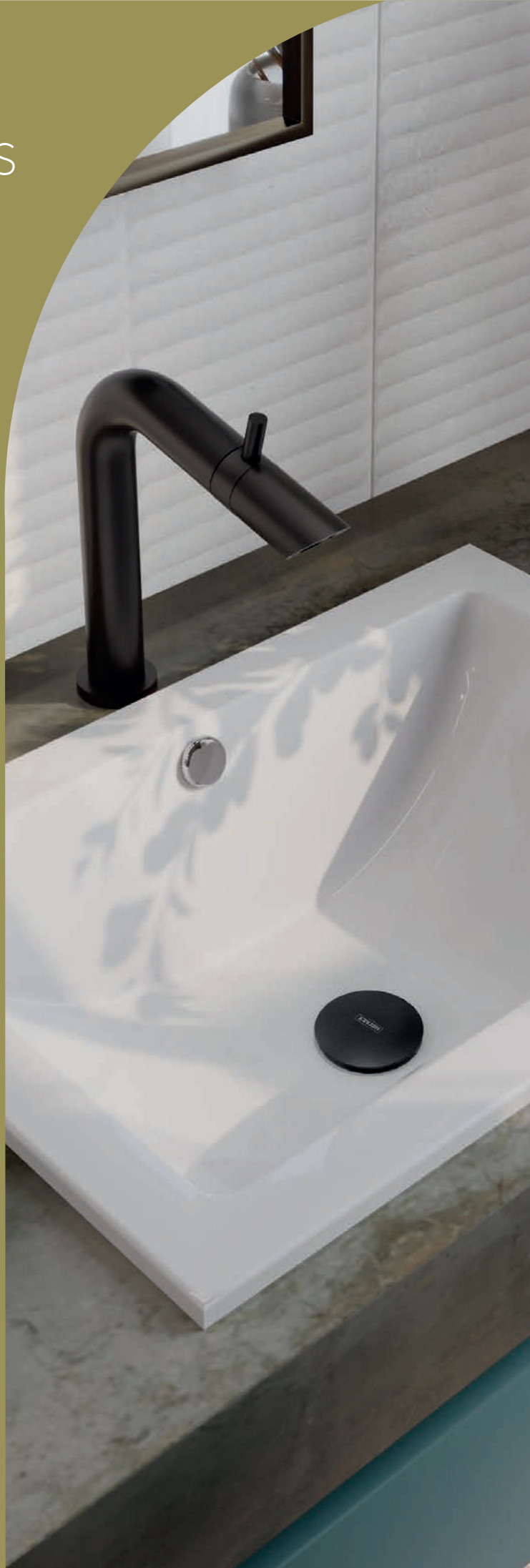

CONTRAS Y COMPLEMENTOS PARA LAVABO

TIPOS DE CONTRAS



CONTRA DE PUSH

Presione LA TAPA para cerrar la contra y vuelva a PRESIONAR para abrirla y dejar drenar EL AGUA.



CONTRA DE HONGO

El agua drenará alrededor de LA TAPA.

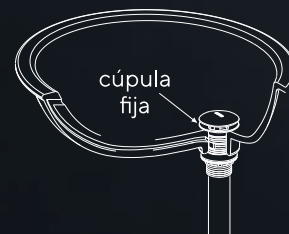
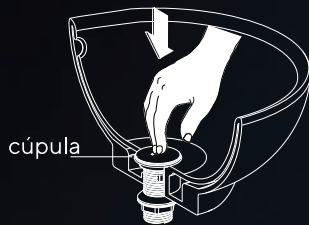

CONTRA DE REJILLA

El agua drenará a través de LA REJILLA.

cúpula fija con rejilla

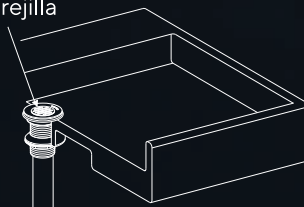

HELVEX

Garantía de Calidad



Garantía Helvex en acabado cromo de 10 años y resto de acabados 2 años.

CONTRAS Y COMPLEMENTOS PARA LAVABO

TH-058

Cromo

\$1,504.00

Contra con rejilla para lavabo con rebosadero.



Dimensiones:
vista cenital

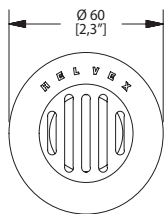

Dimensiones:
vista lateral

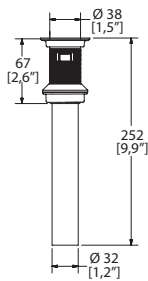

Acabado.

CR

TH-059

Cromo

\$1,504.00

Contra con rejilla para lavabo sin rebosadero.



Dimensiones:
vista cenital

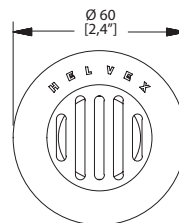

Dimensiones:
vista lateral

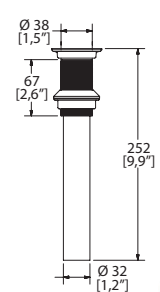

Acabado.

CR

TH-062

Cromo

\$1,454.00

Contra tipo hongo para lavabo con rebosadero.



Dimensiones:
vista cenital

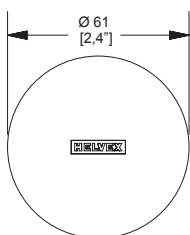

Dimensiones:
vista lateral

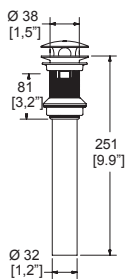

Acabado.

CR

TH-063

Cromo

\$1,454.00

Contra tipo hongo para lavabo sin rebosadero.



Dimensiones:
vista cenital

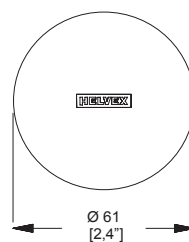

Dimensiones:
vista lateral

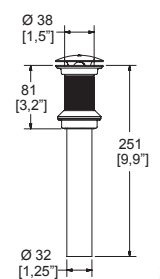

Acabado.

CR

TH-064

Cromo

\$ 1,742.00

Contra de push para lavabo con rebosadero.



Acabado.

CR

TH-065

Cromo

\$ 1,742.00

Contra de push para lavabo sin rebosadero.



Acabado.

CR

TH-064-EB

Ébano

\$ 2,003.00

Contra de push para lavabo con rebosadero.



Acabado.

EB

TH-065-EB

Ébano

\$ 2,003.00

Contra de push para lavabo sin rebosadero.



Acabado.

EB

Dimensiones:
vista cenital

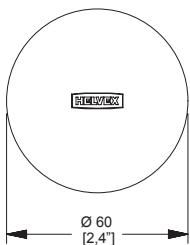

Dimensiones:
vista cenital

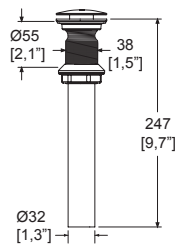

Dimensiones:
vista frontal

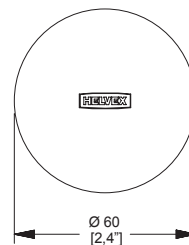

Dimensiones:
vista lateral

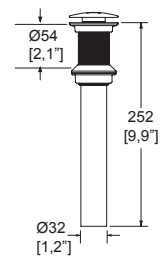

CONTRAS Y COMPLEMENTOS PARA LAVABO

TH-001

Cromo

\$ 590.00

Tubo extensión de **37 cm** para contra de lavabo.



Dimensiones

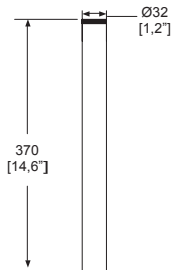

Acabado.



CR

TV-012

Cromo

\$ 807.00

Válvula de paso roscable.

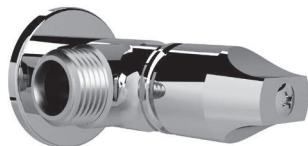

Dimensiones:
vista frontal

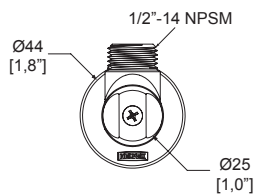

Dimensiones:
vista lateral

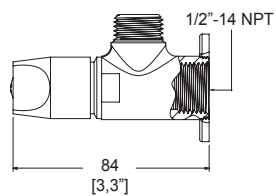

Acabado 100% latón
Para instalarse en lavabos, fregaderos y WC.



CR



TV-016

Cromo

\$ 1,725.00

Césped para lavabo con registro.
No incluye contra.



Acabado.

CR

TV-016-40

Cromo

\$ 2,163.00

Césped para lavabo de **40 cm** de largo con registro.
No incluye contra.



Acabado.

CR

TV-016-EB

Ébano

\$ 1,984.00



Césped para lavabo con registro.
No incluye contra.



Acabado.

EB

TV-016-40-EB

Ébano

\$ 2,487.00



Césped para lavabo de **40 cm** de largo con registro.
No incluye contra.



Acabado.

EB

Dimensiones:
vista frontal

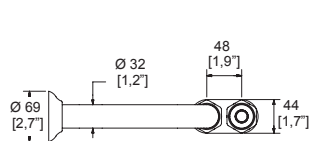

Dimensiones:
vista lateral

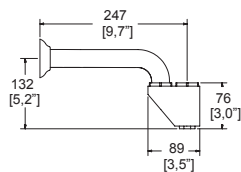

Dimensiones:
vista frontal

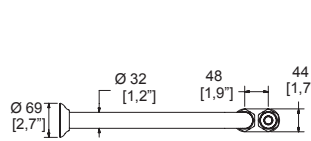

Dimensiones:
vista lateral

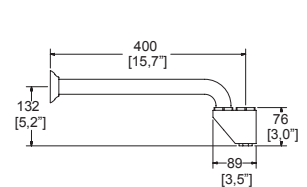

CÉSPOL PARA LAVABO

TV-017

Cromo

\$ 1,999.00

Césped para lavabo con registro.
No incluye contra.



Acabado.

CR

TV-017-40

Cromo

\$ 2,295.00

Césped para lavabo de **40 cm** de largo con registro.
No incluye contra.



Acabado.

CR

TV-017-EB

Ébano

\$ 2,299.00

Césped para lavabo con registro.
No incluye contra.



Acabado.

EB

TV-017-40-EB

Ébano

\$ 2,639.00

Césped para lavabo de **40 cm** de largo con registro.
No incluye contra.



Acabado.

EB

Dimensiones:
vista frontal

Dimensiones:
vista lateral

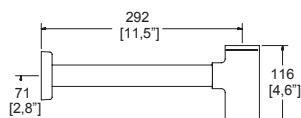

Dimensiones:
vista frontal

Dimensiones:
vista lateral

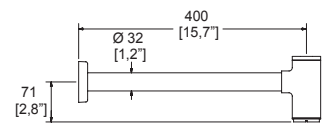
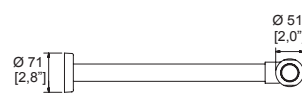

ACABADOS

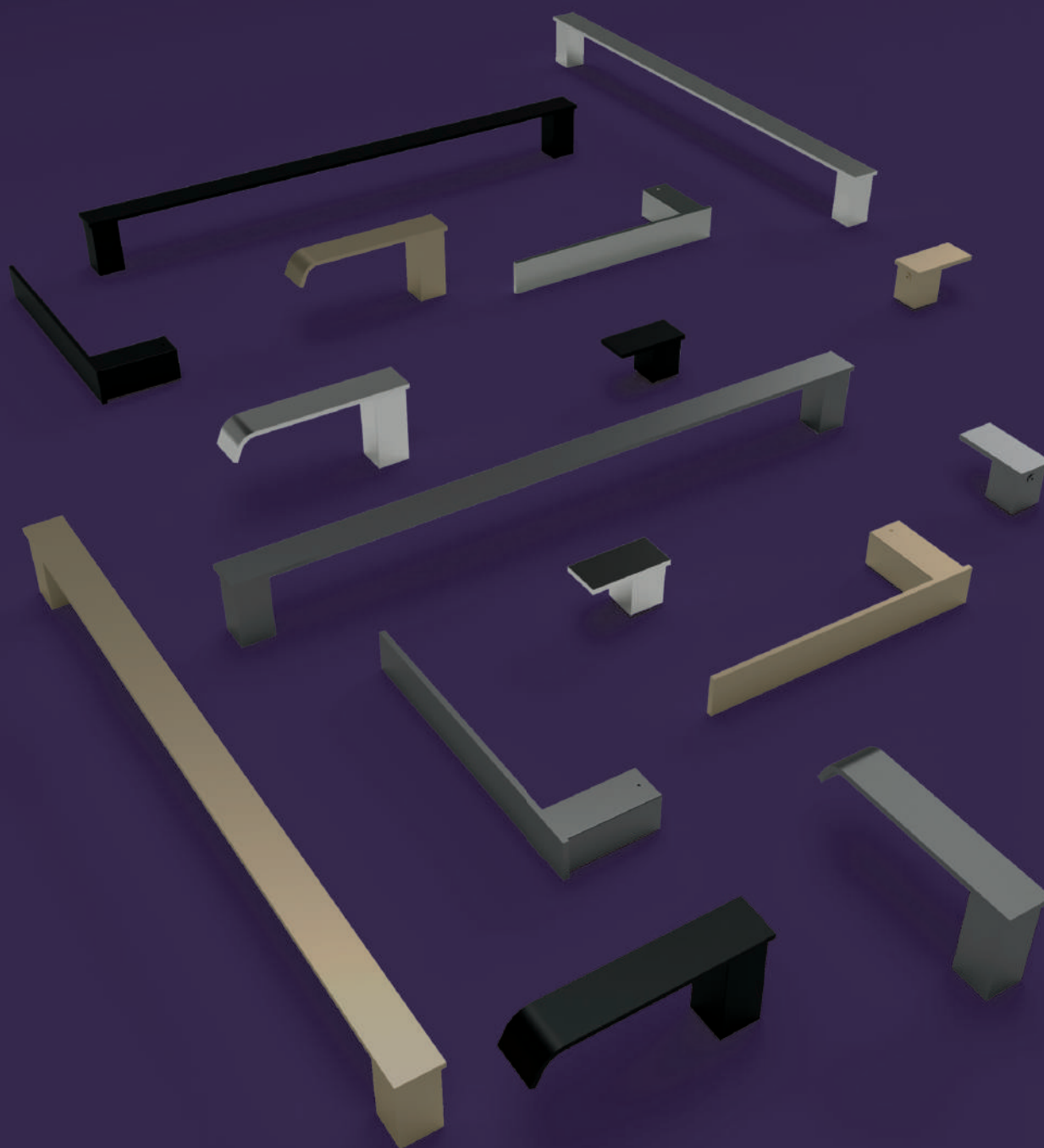

CR
Cromo



EB
Ébano



AU
Aura



DN
Duna



TN
Titanium

ACCESORIOS



Jaboneras.



Portapapel.



Cepilleros.



Toalleros.



Ganchos.



Ganchos multiusos.



Barra de seguridad residencial.



Rejillas.



Repisas.



Espejos.



Agarraderas de tina.



Tendedero retráctil.





HELVEX®
Garantía de Calidad



Garantía Helvex en acabado cromo de 10 años
y resto de acabados 2 años.

ACCESS CROMO

ACCESS

ACC-105

Cromo

\$ 2,046.00

Toallero de barra.



Dimensiones:
vista frontal

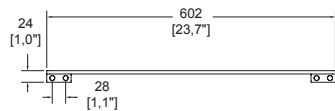

Dimensiones:
vista cenital

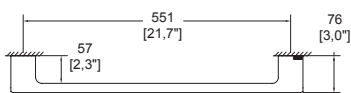

Acabado.



ACCESS

ACC-106

Cromo

\$ 709.00

Gancho sencillo.



Dimensiones:
vista frontal

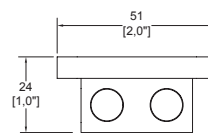

Dimensiones:
vista lateral

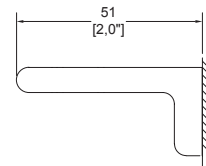

Acabado.



ACCESS

ACC-107

Cromo

\$ 933.00

Portacepillos.



Dimensiones:
vista frontal

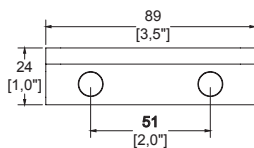

Dimensiones:
vista lateral

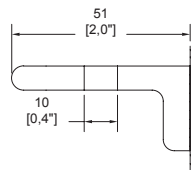

Acabado.



ACCESS

ACC-108

Cromo

\$ 1,020.00

Jabonera.



Dimensiones:
vista frontal

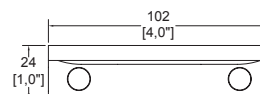

Dimensiones:
vista lateral

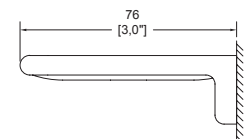

Acabado.



ACCESS

ACC-109

Cromo

\$ 1,104.00

Toallero sencillo.



Dimensiones:
vista frontal

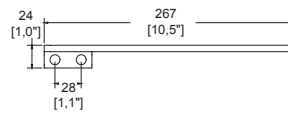

Dimensiones:
vista lateral

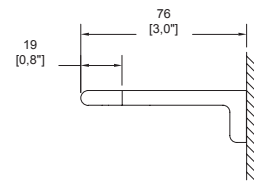

Acabado.



CR

ACCESS

ACC-117

Cromo

\$ 1,426.00

Portapapel.



Dimensiones:
vista frontal

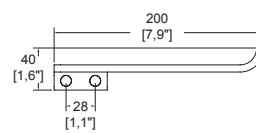

Dimensiones:
vista lateral

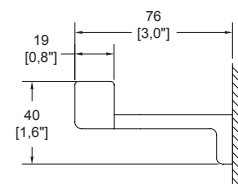

Acabado.



CR



ACCESS ÉBANO

ACCESS

ACC-105-EB

Ébano

\$ 2,352.00

Toallero de barra.



Dimensiones:
vista frontal

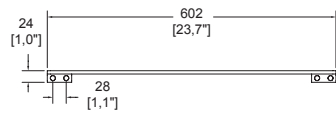

Dimensiones:
vista cenital

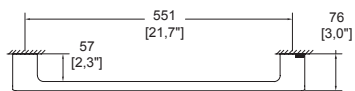

Acabado.



EB

ACCESS

ACC-106-EB

Ébano

\$ 814.00

Gancho sencillo.

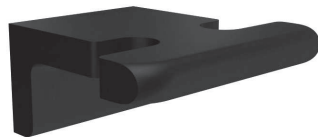

Dimensiones:
vista frontal

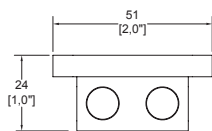

Dimensiones:
vista lateral

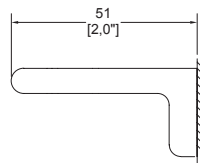

Acabado.



EB



**ACCESS
ACC-107-EB**

Ébano

\$ 1,072.00

Portacepillos.



Dimensiones:
vista frontal

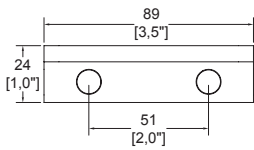

Dimensiones:
vista lateral

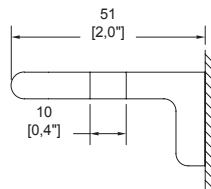

Acabado.



EB

**ACCESS
ACC-108-EB**

Ébano

\$ 1,172.00

Jabonera.



Dimensiones:
vista frontal

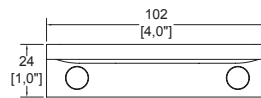

Dimensiones:
vista lateral

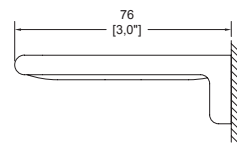

Acabado.



EB

**ACCESS
ACC-109-EB**

Ébano

\$ 1,269.00

Toallero sencillo.



Dimensiones:
vista frontal

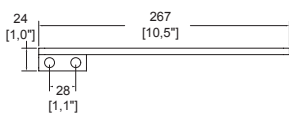

Dimensiones:
vista lateral

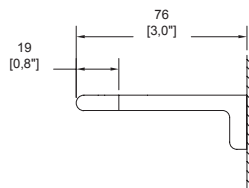

Acabado.



EB

**ACCESS
ACC-117-EB**

Ébano

\$ 1,640.00

Portapapel.



Dimensiones:
vista frontal

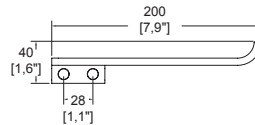

Dimensiones:
vista lateral

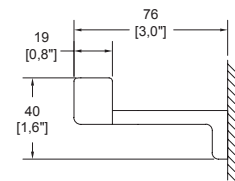

Acabado.



EB

CLÁSICA CROMO

CLÁSICA 34

Cromo

\$1,517.00

Portapapel vertical y/o de repuesto.



Dimensiones:
vista frontal

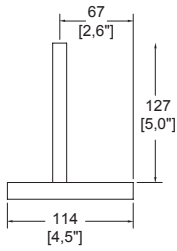

Dimensiones:
vista lateral

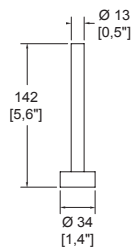

Acabado.

CR

CLÁSICA 100

Cromo

\$1,910.00

Jabonera de empotrar con agarradera. Incluye charola antirrobo.



Dimensiones:
vista frontal

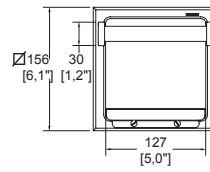

Dimensiones:
vista lateral

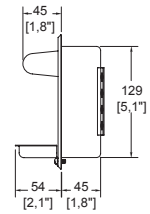

Acabado.

CR



CLÁSICA 101

Cromo

\$1,717.00

Jabonera de empotrar con agarradera. Incluye charola de acrílico.



Dimensiones:
vista frontal

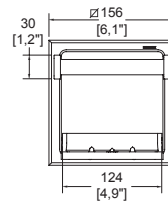

Dimensiones:
vista lateral

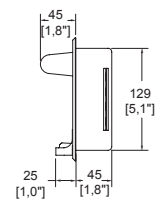

Acabado

CR

CLÁSICA

104

Cromo

\$ 1,730.00

Portapapel de empotrar.
Incluye tubo portapapel.



Dimensiones:
vista frontal

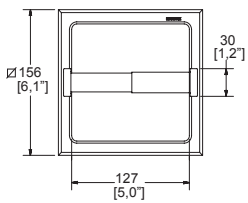

Dimensiones:
vista lateral

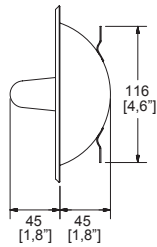

Acabado.

CR

CLÁSICA

105

Cromo

\$ 2,224.00

Toallero de barra.



Dimensiones:
vista frontal

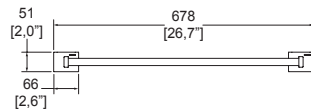

Dimensiones:
vista cenital

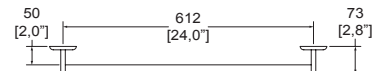

Acabado.

CR

CLÁSICA

105-45

Cromo

\$ 2,072.00

Toallero de barra de **45 cm.**
Ideal para espacios reducidos.



Dimensiones:
vista frontal

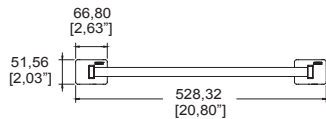

Dimensiones:
vista cenital

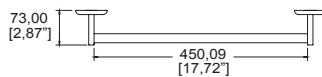

Acabado.

CR

CLÁSICA

106

Cromo

\$ 743.00

Gancho doble.



Dimensiones:
vista cenital

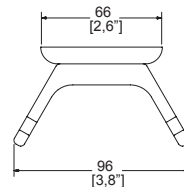

Dimensiones:
vista lateral

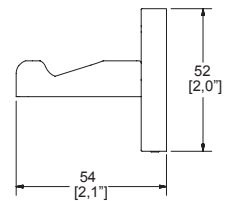

Acabado.

CR

CLÁSICA CROMO

CLÁSICA

107

Cromo

\$ 946.00

Portavaso cepillero.



Dimensiones:
vista cenital

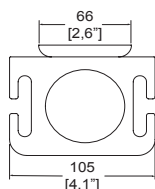

Dimensiones:
vista lateral

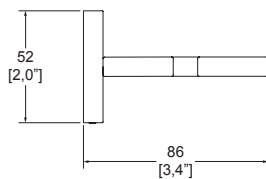

Acabado.

CR

CLÁSICA

108

Cromo

\$ 1,096.00

Jabonera.



Dimensiones:
vista cenital

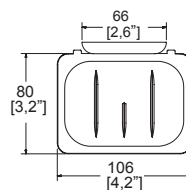

Dimensiones:
vista lateral

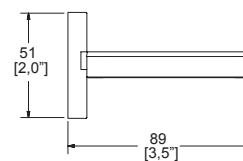

Acabado.

CR



CLÁSICA

109

Cromo

\$ 1,099.00

Toallero de argolla.



Dimensiones:
vista frontal

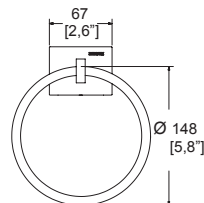

Dimensiones:
vista lateral

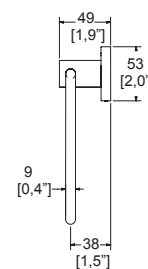

Acabado.

CR

CLÁSICA

110

Cromo

\$ 4,457.00

Portatoallas múltiple.



Dimensiones:
vista cenital

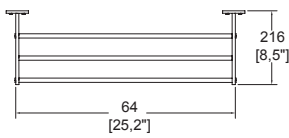

Dimensiones:
vista lateral

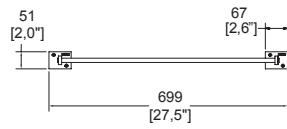

Acabado.



CR

CLÁSICA

114

Cromo

\$ 2,458.00

Portapapel de empotrar con cubierta.



Dimensiones:
vista frontal

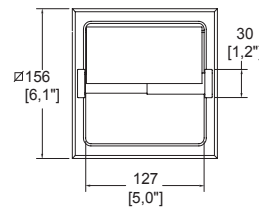

Dimensiones:
vista lateral

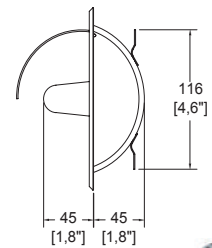

Acabado.



CR

CLÁSICA

115

Cromo

\$ 2,086.00

Portapapel de empotrar con tubo antirrobo.

Seguro antirrobo



Dimensiones:
vista frontal

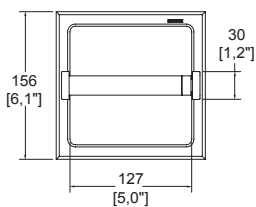

Dimensiones:
vista lateral

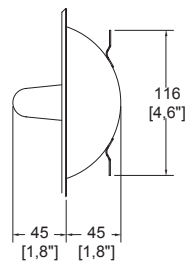

Acabado.



CR



CLÁSICA CROMO

CLÁSICA

117

Cromo

\$ 1,527.00

Portapapel.



Dimensiones:
vista frontal

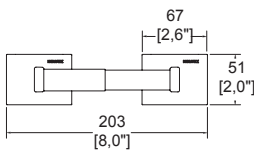

Dimensiones:
vista cenital

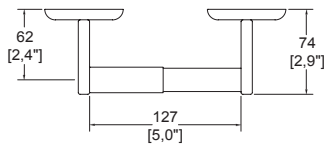

Acabado.



CLÁSICA

122

Cromo

\$ 1,840.00

Tendedero retráctil,
longitud 3.25 m.

Accesorio
institucional



Dimensiones:
vista frontal

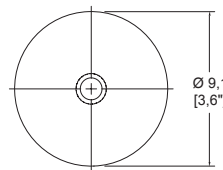

Dimensiones:
vista lateral

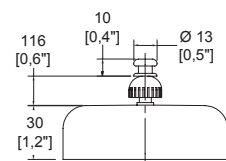

Carga máxima 2,5 kg.
Tendedero de uso para interiores.



CLÁSICA

123

Cromo

\$ 696.00

Destapador.

Accesorio
institucional



Dimensiones:
vista frontal

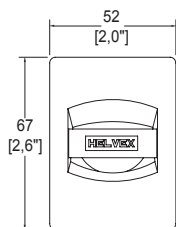

Dimensiones:
vista lateral

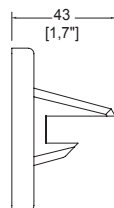

Acabado.



CLÁSICA

124

Cromo

\$ 5,650.00

Portatoallas múltiple
con toallero.



Dimensiones:
vista frontal

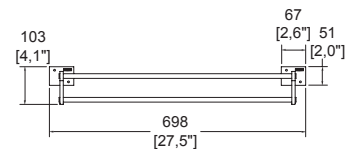

Dimensiones:
vista cenital

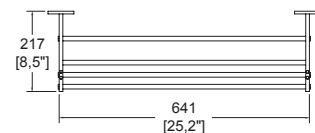

Acabado.



CLÁSICA
158

Cromo

\$ 4,788.00

Agarradera para tina con jabonera de rejilla, convertible a derecha o izquierda.

Accesorio **institucional**



Dimensiones:
vista frontal

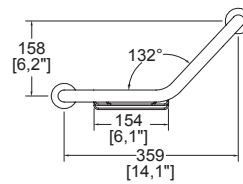

Dimensiones:
vista cenital

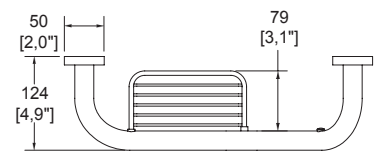

Carga máxima aplicada 100 kg,
máximo por un periodo de 5 minutos.



CR

CLÁSICA
266

Cromo

\$ 968.00

Gancho multiusos reforzado.

Accesorio **institucional**



Dimensiones:
vista frontal



Dimensiones:
vista lateral

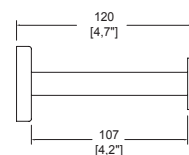

Soporta hasta 50 kg.



CR

CLÁSICA II CROMO

CLÁSICA II 205

Cromo

\$ 2,224.00

Toallero de barra.

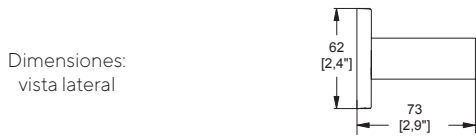
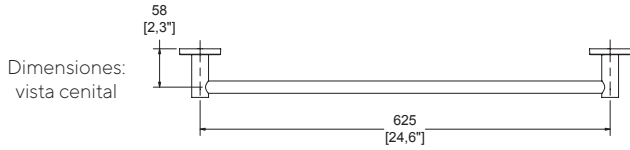

Acabado.

CR

CLÁSICA II 205-45

Cromo

\$ 2,072.00

Toallero de barra de **45 cm.**
Ideal para espacios reducidos.

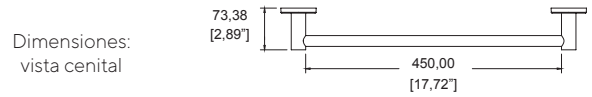

Acabado.

CR

CLÁSICA II 206

Cromo

\$ 743.00

Gancho doble.



Dimensiones: vista cenital

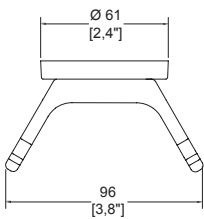

Dimensiones: vista lateral

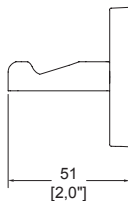

Acabado.

CR

CLÁSICA II 207

Cromo

\$ 946.00

Portacepillos.



Dimensiones: vista frontal

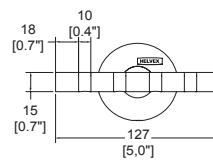

Dimensiones: vista lateral

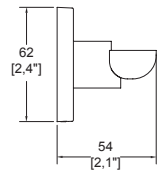

Acabado.

CR

CLÁSICA II
208

Cromo

\$ 1,092.00

Jabonera.



Dimensiones:
vista cenital

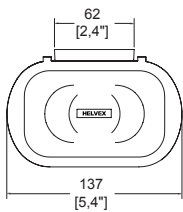

Dimensiones:
vista lateral

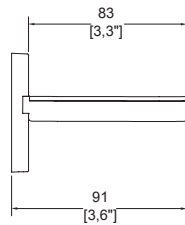

Acabado.



CLÁSICA II
209

Cromo

\$ 1,099.00

Toallero de argolla.



Dimensiones:
vista frontal

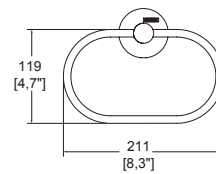

Dimensiones:
vista lateral

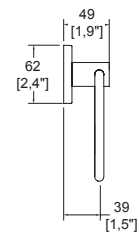

Acabado.



CLÁSICA II
210

Cromo

\$ 4,457.00

Portatoallas múltiple.



Dimensiones:
vista frontal

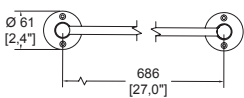

Dimensiones:
vista cenital

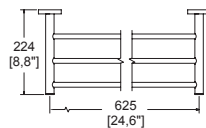

Acabado.



Accesorio
institucional



CLÁSICA II CROMO

CLÁSICA II 215

Cromo

\$ 2,098.00

Portapapel con tubo antirrobo.

Accesorio institucional



Dimensiones: vista cenital

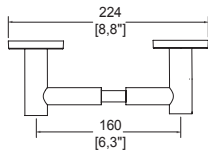

Dimensiones: vista lateral

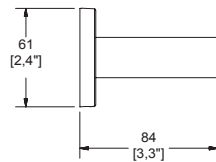

Acabado.



CR

CLÁSICA II 217

Cromo

\$ 1,527.00

Portapapel.



Dimensiones: vista cenital

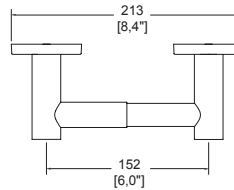

Dimensiones: vista lateral

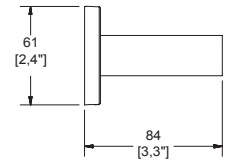

Acabado.



CR

CLÁSICA II 219

Cromo

\$ 3,359.00

Portapapel doble con tubos antirrobo.

Accesorio institucional



Dimensiones: vista cenital

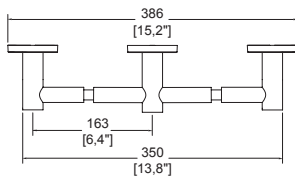

Dimensiones: vista lateral

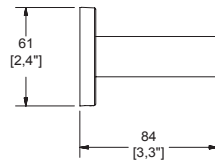

Acabado.



CR

CLÁSICA II 223

Cromo

\$ 692.00

Destapador.

Accesorio institucional



Dimensiones: vista frontal



Dimensiones: vista lateral

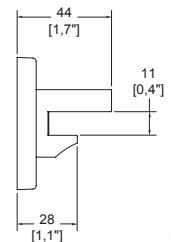

Acabado.



CR

**PREMIER
15104**

Cromo

\$ 1,769.00

Portapapel.



Dimensiones:
vista cenital

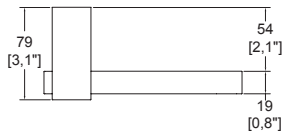

Dimensiones:
vista lateral

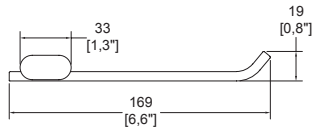

Acabado.



CR

**PREMIER
15105**

Cromo

\$ 3,166.00

Toallero de barra.



Dimensiones:
vista cenital

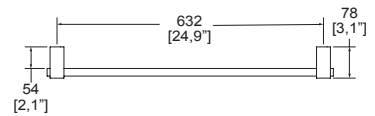

Dimensiones:
vista lateral

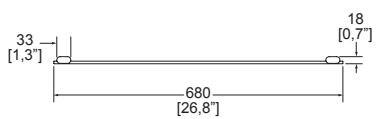

Acabado.



CR

**PREMIER
15106**

Cromo

\$ 773.00

Gancho sencillo.

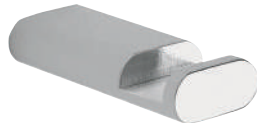

Dimensiones:
vista cenital

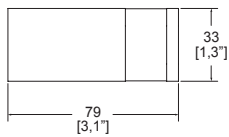

Dimensiones:
vista lateral

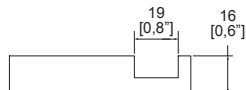

Acabado.



CR

**PREMIER
15107**

Cromo

\$ 1,595.00

Portacepillos.



Dimensiones:
vista cenital

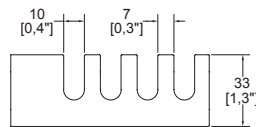

Dimensiones:
vista frontal

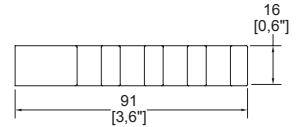

Acabado.



CR

PREMIER CROMO

PREMIER

15108

Cromo

\$ 2,123.00

Jabonera.



Dimensiones:
vista cenital

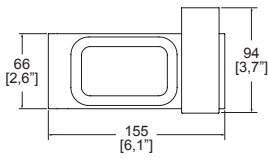

Dimensiones:
vista lateral



Acabado.



CR

PREMIER

15109

Cromo

\$ 1,708.00

Toallero sencillo.



Dimensiones:
vista cenital

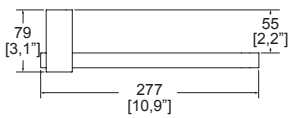

Dimensiones:
vista lateral



Acabado.



CR



PREMIER

15104-EB

Ébano

\$ 2,032.00

Portapapel.



Dimensiones:
vista cenital

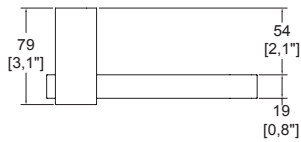

Dimensiones:
vista lateral

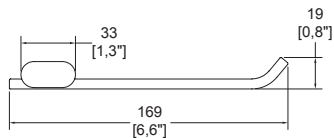

Acabado.



EB

PREMIER

15105-EB

Ébano

\$ 3,641.00

Toallero de barra.



Dimensiones:
vista cenital

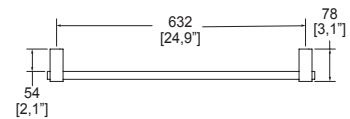

Dimensiones:
vista lateral

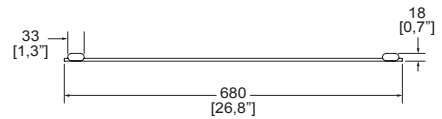

Acabado.



EB

PREMIER

15106-EB

Ébano

\$ 889.00

Gancho sencillo.



Dimensiones:
vista cenital

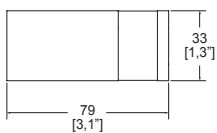

Dimensiones:
vista lateral

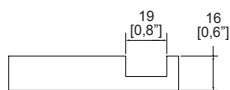

Acabado.



EB

PREMIER

15107-EB

Ébano

\$ 1,822.00

Portacepillos.

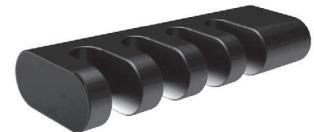

Dimensiones:
vista cenital

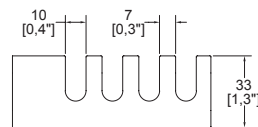

Dimensiones:
vista frontal

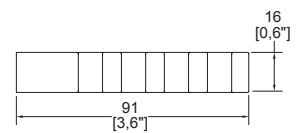

Acabado.



EB

PREMIER ÉBANO

PREMIER

15108-EB

Ébano

\$ 2,440.00

Jabonera.



Dimensiones:
vista cenital

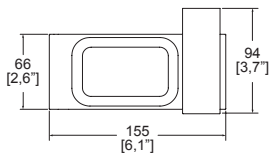

Dimensiones:
vista lateral



Acabado.



EB

PREMIER

15109-EB

Ébano

\$ 1,963.00

Toallero sencillo.



Dimensiones:
vista cenital

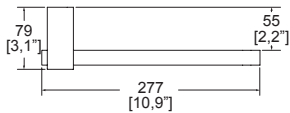

Dimensiones:
vista lateral



Acabado.



EB



**NUVA
9105**

Cromo

\$ 3,832.00

Toallero de barra.



Dimensiones:
vista frontal

Dimensiones:
vista cenital

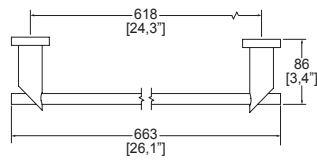
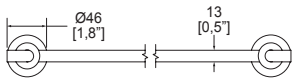

Acabado.

CR

**NUVA
9106**

Cromo

\$ 1,501.00

Gancho sencillo.



Dimensiones:
vista frontal

Dimensiones:
vista lateral

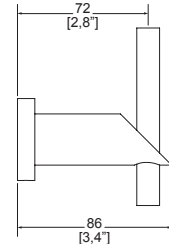
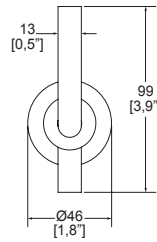

Acabado.

CR

**NUVA
9107**

Cromo

\$ 3,094.00

Vaso cepillero de cristal.



Dimensiones:
vista frontal

Dimensiones:
vista cenital

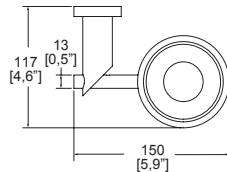
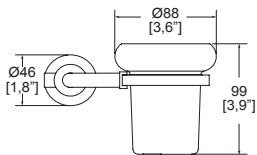

Acabado.

CR

**NUVA
9109**

Cromo

\$ 2,374.00

Toallero corto.



Dimensiones:
vista frontal

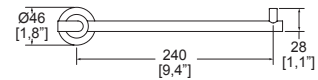

Dimensiones:
vista cenital

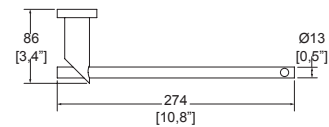

Acabado.

CR

NUVA CROMO

NUVA

9117

Cromo

\$ 1,776.00

Portapapel.



Dimensiones:
vista frontal

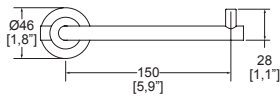

Dimensiones:
vista cenital

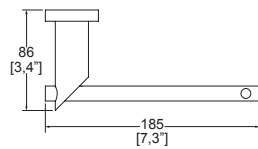

Acabado.



CR

NUVA

9124

Cromo

\$ 5,890.00

Portatoallas múltiple
con toallero.



Dimensiones:
vista cenital

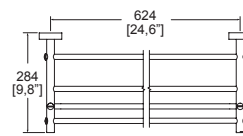

Dimensiones:
vista lateral

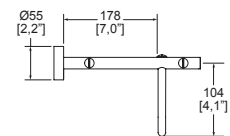

Acabado.



CR



NUVA

9128

Cromo

\$ 2,965.00

Jabonera.



Dimensiones:
vista cenital

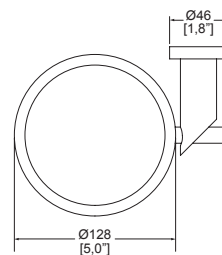

Dimensiones:
vista lateral

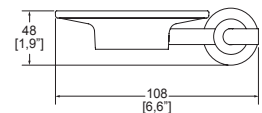

Acabado.



CR

EXPLORA

HOT-105

Cromo

\$ 2,433.00

Toallero de barra.



Dimensiones:
vista frontal

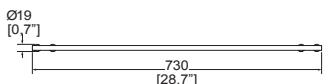

Dimensiones:
vista cenital

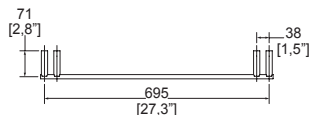

Acabado.



CR

EXPLORA

HOT-105-45

Cromo

\$ 2,266.00

Toallero de barra de **45 cm.**
Ideal para espacios reducidos.



Dimensiones:
vista frontal

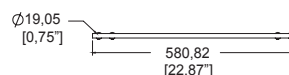

Dimensiones:
vista cenital

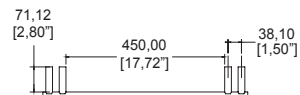

Acabado.



CR

EXPLORA

HOT-106

Cromo

\$ 821.00

Gancho sencillo.



Dimensiones:
vista cenital

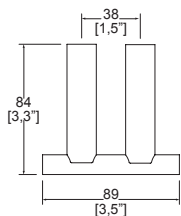

Dimensiones:
vista lateral



Acabado.



CR

EXPLORA

HOT-107

Cromo

\$ 1,191.00

Portacepillos.



Dimensiones:
vista cenital

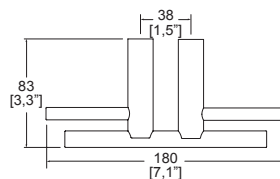

Dimensiones:
vista lateral

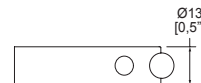

Acabado.



CR

EXPLORA CROMO

EXPLORA HOT-108

Cromo

\$ 1,186.00

Jabonera.



Dimensiones:
vista cenital

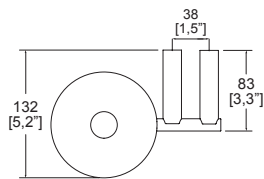

Dimensiones:
vista lateral

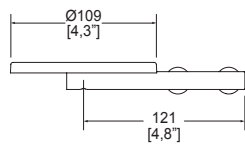

Acabado.



EXPLORA HOT-109

Cromo

\$ 1,618.00

Toallero sencillo.



Dimensiones:
vista frontal



Dimensiones:
vista cenital

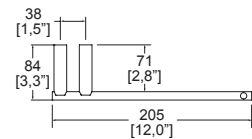

Acabado.



EXPLORA HOT-117

Cromo

\$ 1,559.00

Portapapel.



Dimensiones:
vista frontal



Dimensiones:
vista cenital

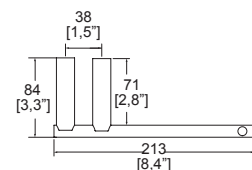

Acabado.



KONOS
2104

Cromo

\$ 1,448.00

Portapapel.



Dimensiones:
vista frontal

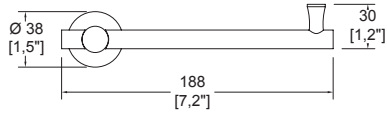

Dimensiones:
vista cenital

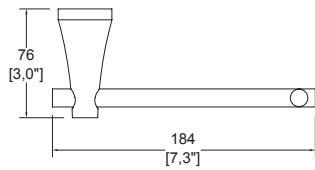

Acabado.



KONOS
2105

Cromo

\$ 2,332.00

Toallero de barra.



Dimensiones:
vista cenital

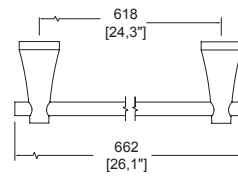

Dimensiones:
vista lateral

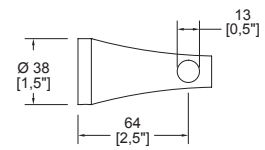

Acabado.



KONOS
2106

Cromo

\$ 941.00

Gancho doble.



Dimensiones:
vista frontal

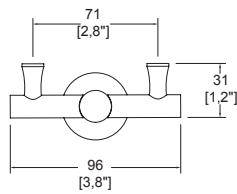

Dimensiones:
vista lateral

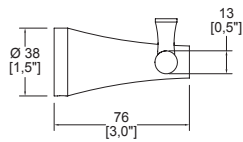

Acabado.



KONOS
2107

Cromo

\$ 1,581.00

Portacepillos.



Dimensiones:
vista frontal

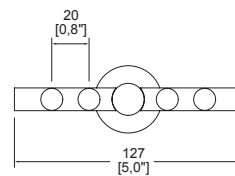

Dimensiones:
vista lateral

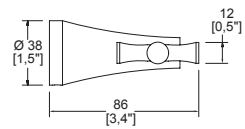

Acabado.



KONOS CROMO

KONOS

2108

Cromo

\$ 1,602.00

Jabonera.



Dimensiones:
vista cenital

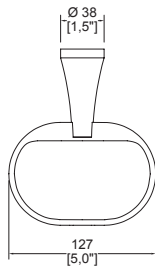

Dimensiones:
vista lateral

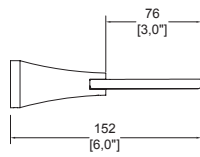

Acabado.



CR

KONOS

2109

Cromo

\$ 1,527.00

Toallero sencillo.



Dimensiones:
vista frontal

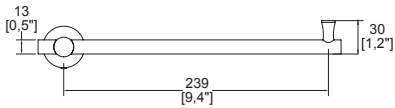

Dimensiones:
vista lateral

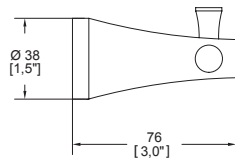

Acabado.



CR



KÚBICA 14104

Cromo

\$ 1,898.00

Portapapel.



Dimensiones:
vista frontal

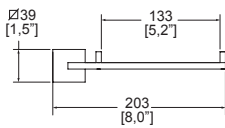

Dimensiones:
vista cenital

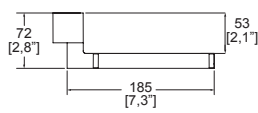

Acabado.



KÚBICA 14105

Cromo

\$ 4,135.00

Toallero de barra.



Dimensiones:
vista frontal

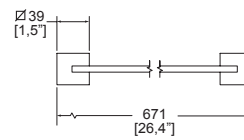

Dimensiones:
vista cenital

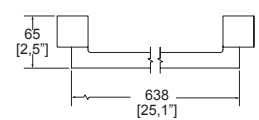

Acabado.



KÚBICA 14106

Cromo

\$ 1,608.00

Gancho doble.

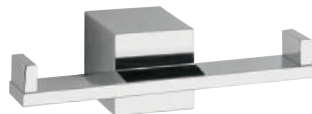

Dimensiones:
vista cenital

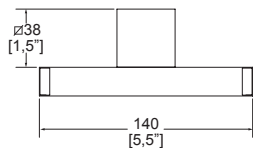

Dimensiones:
vista lateral

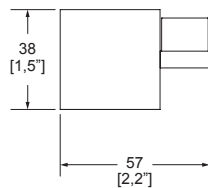

Acabado.



KÚBICA 14109

Cromo

\$ 2,545.00

Toallero sencillo.



Dimensiones:
vista cenital

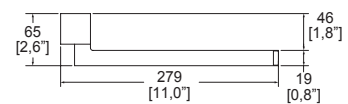

Dimensiones:
vista lateral

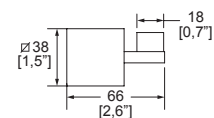

Acabado.





MÁXIMA 20105

Cromo

\$ 3,166.00

Toallero de barra.

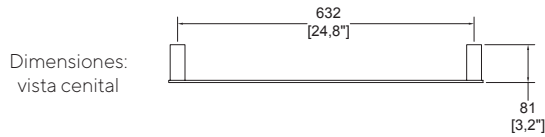
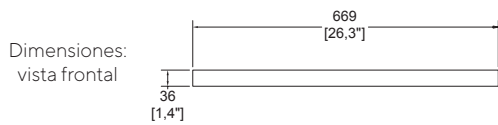

Acabado.



CR

MÁXIMA 20106

Cromo

\$ 773.00

Gancho sencillo.



Dimensiones:
vista frontal

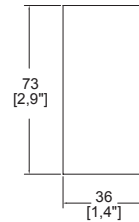

Dimensiones:
vista lateral

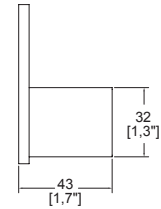

Acabado.



CR

MÁXIMA 20109

Cromo

\$ 1,708.00

Toallero sencillo.

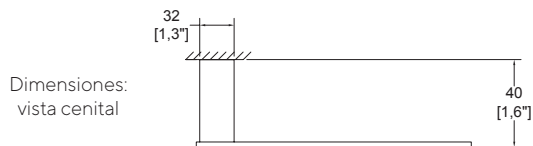
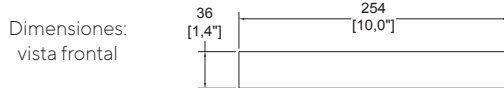

Acabado.



CR

MÁXIMA 20117

Cromo

\$ 1,769.00

Portapapel.



Dimensiones:
vista frontal

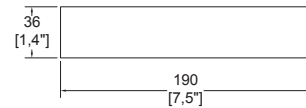

Dimensiones:
vista cenital



Acabado.



CR



MÁXIMA
20105-EB

Ébano

\$ 3,640.00

Toallero de barra.

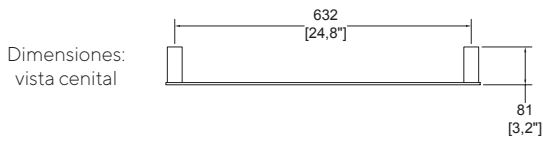
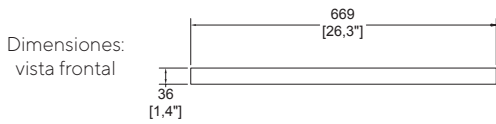
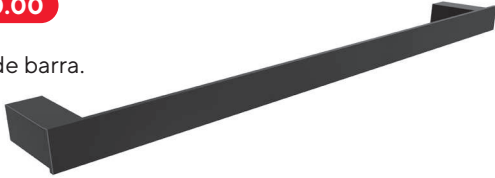

Acabado.

EB

MÁXIMA
20106-EB

Ébano

\$ 889.00

Gancho sencillo.



Dimensiones:
vista frontal

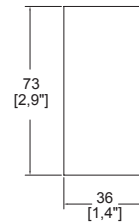

Dimensiones:
vista lateral

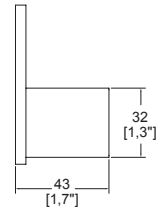

Acabado.

EB

MÁXIMA
20109-EB

Ébano

\$ 1,965.00

Toallero sencillo.

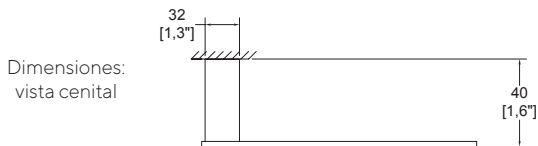
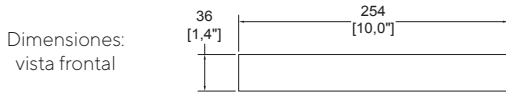

Acabado.

EB

MÁXIMA
20117-EB

Ébano

\$ 2,034.00

Portapapel.



Dimensiones:
vista frontal

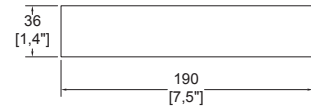

Dimensiones:
vista cenital



Acabado.

EB



MÁXIMA 20105-DN

Duna

\$ 3,640.00

Toallero de barra.

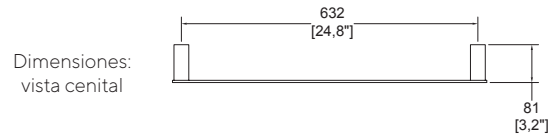
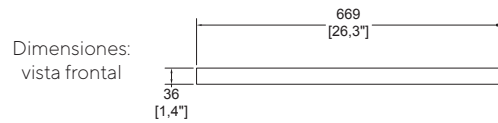

Acabado.

DN

MÁXIMA 20106-DN

Duna

\$ 889.00

Gancho sencillo.



Dimensiones:
vista frontal

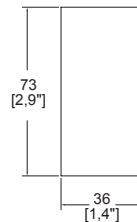

Dimensiones:
vista lateral

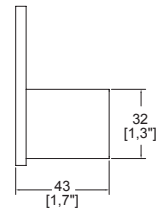

Acabado.

DN



MÁXIMA

20109-DN

Duna

\$ 1,965.00

Toallero sencillo.



Dimensiones:
vista frontal

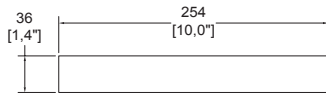

Dimensiones:
vista cenital

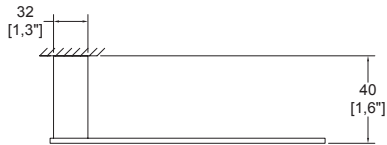

Acabado.



DN

MÁXIMA

20117-DN

Duna

\$ 2,034.00

Portapapel.



Dimensiones:
vista frontal

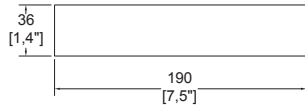

Dimensiones:
vista cenital



Acabado.



DN





MÁXIMA 20105-TN

Titanium

\$ 3,640.00

Toallero de barra.

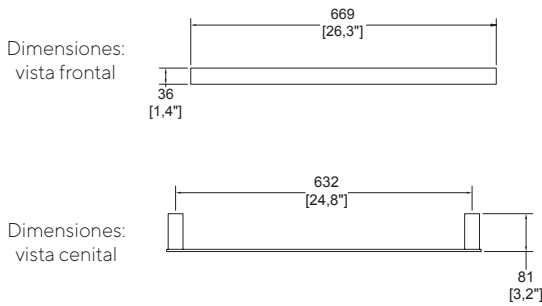

Acabado.



MÁXIMA 20106-TN

Titanium

\$ 889.00

Gancho sencillo.



Dimensiones:
vista frontal

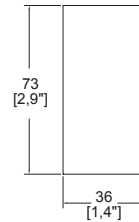

Dimensiones:
vista lateral

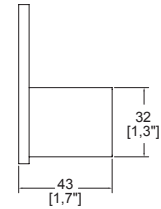

Acabado.



MÁXIMA 20109-TN

Titanium

\$ 1,965.00

Toallero sencillo.

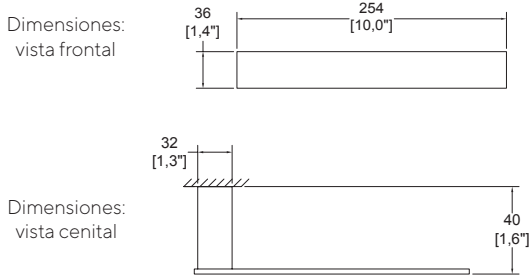

Acabado.



MÁXIMA 20117-TN

Titanium

\$ 2,034.00

Portapapel.



Dimensiones:
vista frontal

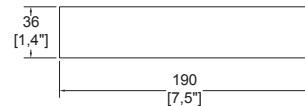

Dimensiones:
vista cenital

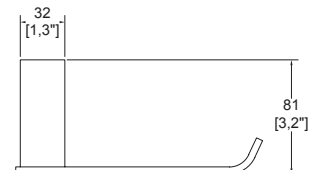

Acabado.



PIAZZA CROMO

PIAZZA PIA-105

Cromo

\$ 1,319.00

Toallero de barra.



Dimensiones:
vista frontal

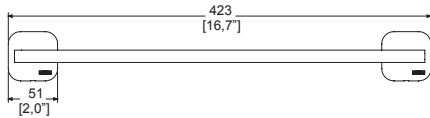

Dimensiones:
vista lateral

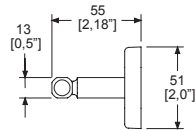

Acabado.

CR

PIAZZA PIA-106

Cromo

\$ 389.00

Gancho sencillo.



Dimensiones:
vista frontal

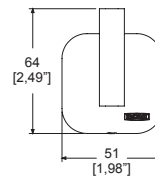

Dimensiones:
vista lateral

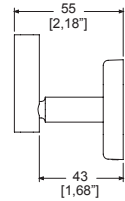

Acabado.

CR

PIAZZA PIA-109

Cromo

\$ 593.00

Toallero sencillo.



Dimensiones:
vista frontal

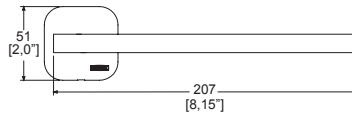

Dimensiones:
vista lateral

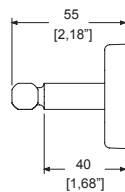

Acabado.

CR

PIAZZA PIA-117

Cromo

\$ 618.00

Portapapel.



Dimensiones:
vista frontal

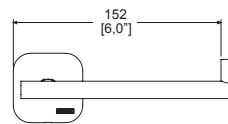

Dimensiones:
vista lateral

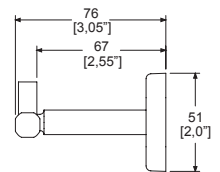

Acabado.

CR

PIAZZA
PIA-105-EB

Ébano

\$ 1,517.00

Toallero de barra.



Dimensiones:
vista frontal

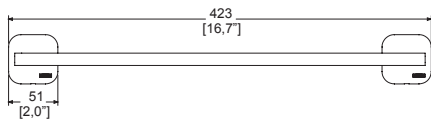

Dimensiones:
vista lateral

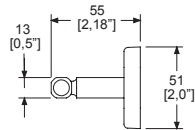

Acabado.



PIAZZA
PIA-106-EB

Ébano

\$ 447.00

Gancho sencillo.



Dimensiones:
vista frontal

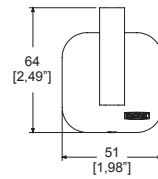

Dimensiones:
vista lateral

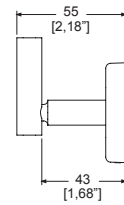

Acabado.



PIAZZA
PIA-109-EB

Ébano

\$ 682.00

Toallero sencillo.



Dimensiones:
vista frontal

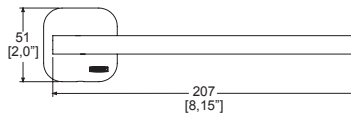

Dimensiones:
vista lateral

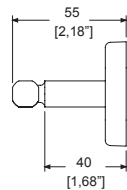

Acabado.



PIAZZA
PIA-117-EB

Ébano

\$ 711.00

Portapapel.



Dimensiones:
vista frontal

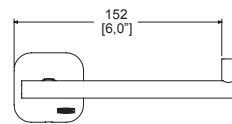

Dimensiones:
vista lateral

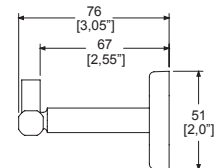

Acabado.



PIURA CROMO

PIURA PIU-05

Cromo

\$ 4,352.00

Toallero de barra.

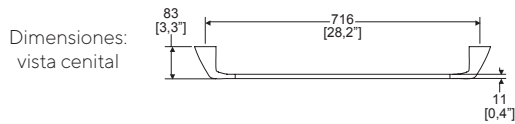
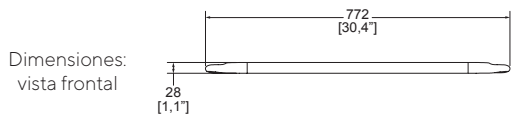

Acabado.



PIURA PIU-06

Cromo

\$ 1,709.00

Gancho sencillo.



Dimensiones:
vista frontal



Dimensiones:
vista lateral

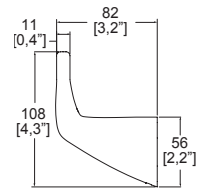

Acabado.



PIURA PIU-09

Cromo

\$ 2,703.00

Toallero sencillo.

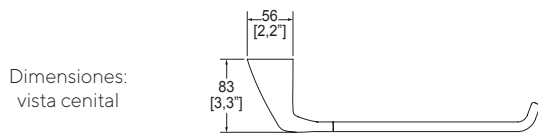
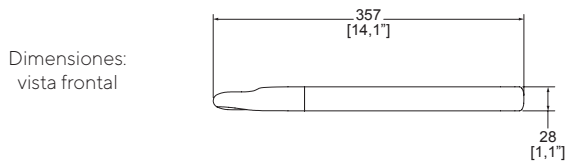

Acabado.



PIURA PIU-17

Cromo

\$ 2,019.00

Portapapel.



Dimensiones:
vista frontal

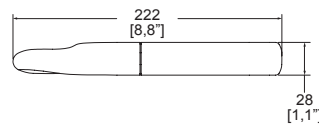

Dimensiones:
vista cenital

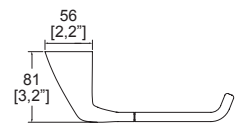

Acabado.



VÉRTIKA
16104

Cromo

\$ 1,832.00

Portapapel.



Dimensiones:
vista frontal

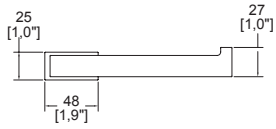

Dimensiones:
vista cenital

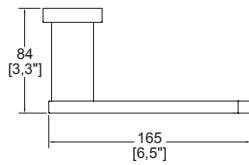

Acabado.



VÉRTIKA
16105

Cromo

\$ 4,003.00

Toallero de barra.



Dimensiones:
vista frontal



Dimensiones:
vista cenital

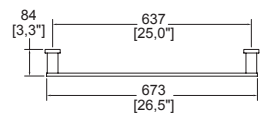

Acabado.



VÉRTIKA
16106

Cromo

\$ 1,544.00

Gancho doble.



Dimensiones:
vista frontal

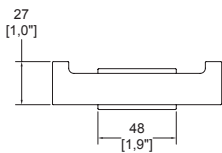

Dimensiones:
vista cenital

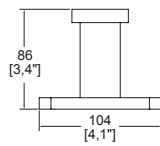

Acabado.



VÉRTIKA CROMO

VÉRTIKA 16107

Cromo

\$ 2,574.00

Portacepillos.



Dimensiones:
vista cenital

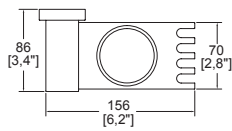

Dimensiones:
vista lateral

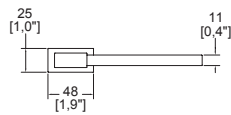

Acabado.



CR

VÉRTIKA 16108

Cromo

\$ 2,574.00

Jabonera.



Dimensiones:
vista cenital

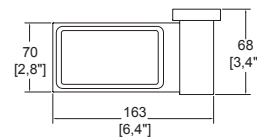

Dimensiones:
vista lateral

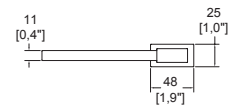

Acabado.



CR



VÉRTIKA 16109

Cromo

\$ 2,445.00

Toallero sencillo.



Dimensiones:
vista cenital

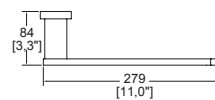

Dimensiones:
vista lateral

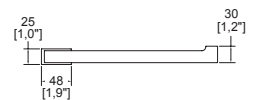

Acabado.



CR



TUBULAR

TUB-05

Cromo

\$ 2,224.00

Toallero de barra.



Dimensiones:
vista cenital

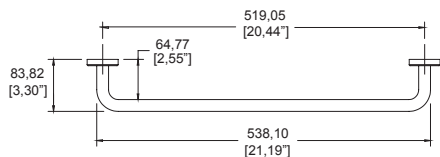

Dimensiones:
vista frontal

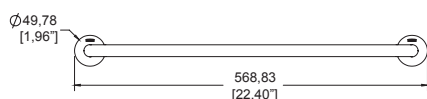

Acabado.



CR

TUBULAR

TUB-06

Cromo

\$ 743.00

Gancho sencillo.



Dimensiones:
vista frontal

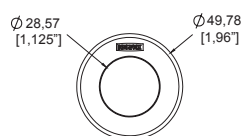

Dimensiones:
vista lateral

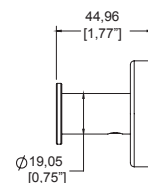

Acabado.



CR

TUBULAR

TUB-09

Cromo

\$ 1,099.00

Toallero sencillo.



Dimensiones:
vista frontal

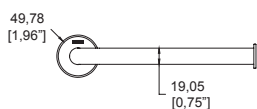

Dimensiones:
vista cenital

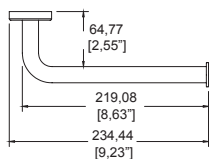

Acabado.



CR

TUBULAR

TUB-10

Cromo

\$ 4,457.00

Portatoallas múltiple.



Dimensiones:
vista cenital

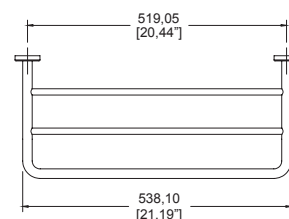

Dimensiones:
vista frontal

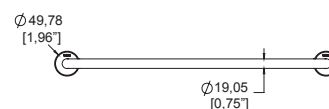

Acabado.



CR

TUBULAR CROMO

TUBULAR TUB-17

Cromo

\$ 1,527.00

Portapapel sencillo.



Dimensiones:
vista frontal

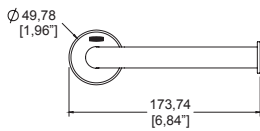

Dimensiones:
vista cenital

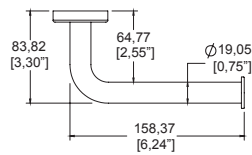

Acabado.



CR

TUBULAR ÉBANO

**NUEVA
LÍNEA**

TUBULAR TUB-05-EB

Ébano

\$ 2,558.00

Toallero de barra.



Dimensiones:
vista cenital

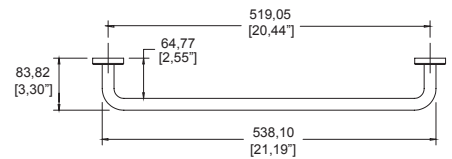

Dimensiones:
vista frontal

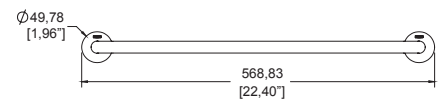

Acabado.



EB

TUBULAR TUB-35

Cromo

\$ 2,290.00

Portapapel con soporte
de apoyo tipo barra
de seguridad.



Dimensiones:
vista frontal

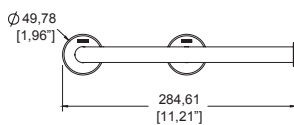

Dimensiones:
vista cenital

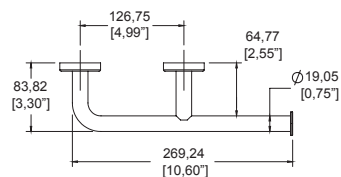

Acabado.



CR

TUBULAR TUB-06-EB

Ébano

\$ 855.00

Gancho sencillo.



Dimensiones:
vista frontal

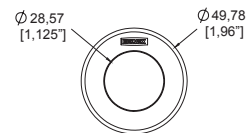

Dimensiones:
vista lateral

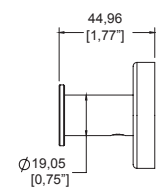

Acabado.



EB

TUBULAR ÉBANO

TUBULAR TUB-09-EB Ébano

\$ 1,265.00

Toallero sencillo.



Dimensiones:
vista frontal

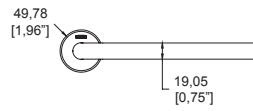

Dimensiones:
vista cenital

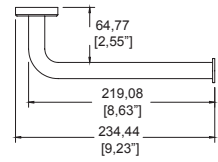

Acabado.



EB

TUBULAR TUB-10-EB Ébano

\$ 5,126.00

Portatoallas múltiple.



Dimensiones:
vista cenital

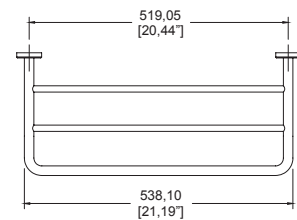

Dimensiones:
vista frontal

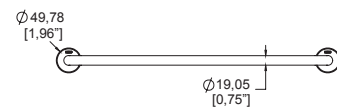

Acabado.



EB

TUBULAR ÉBANO

TUBULAR TUB-17-EB Ébano

\$ 1,755.00

Portapapel sencillo.



Dimensiones:
vista frontal

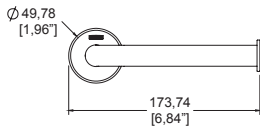

Dimensiones:
vista cenital

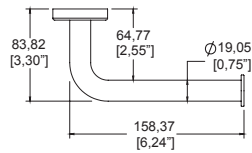

Acabado.

EB

TUBULAR TUB-35-EB Ébano

\$ 2,633.00

Portapapel con soporte
de apoyo tipo barra
de seguridad.



Dimensiones:
vista frontal

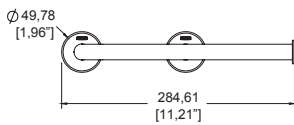

Dimensiones:
vista cenital

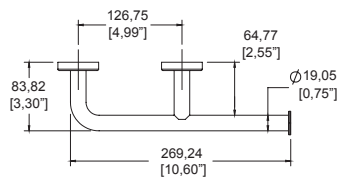

Acabado.

EB

TUBULAR AURA



TUBULAR TUB-05-AU Aura

\$ 2,558.00

Toallero de barra.



Dimensiones:
vista cenital

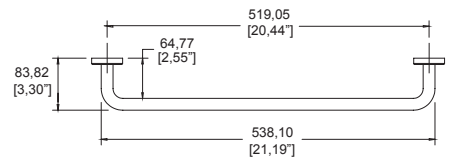

Dimensiones:
vista frontal

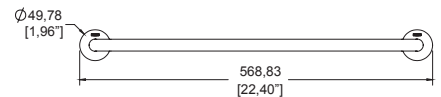

Acabado.

AU

TUBULAR TUB-06-AU Aura

\$ 855.00

Gancho sencillo.



Dimensiones:
vista frontal

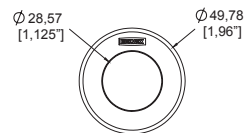

Dimensiones:
vista lateral

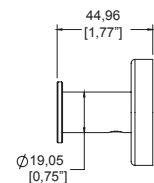

Acabado.

AU

TUBULAR AURA

TUBULAR TUB-09-AU

Aura

\$ 1,265.00

Toallero sencillo.



Dimensiones:
vista frontal

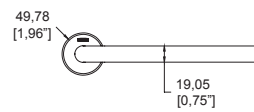

Dimensiones:
vista cenital

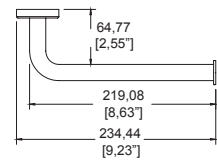

Acabado.

AU

TUBULAR TUB-10-AU

Aura

\$ 5,126.00

Portatoallas múltiple.



Dimensiones:
vista cenital

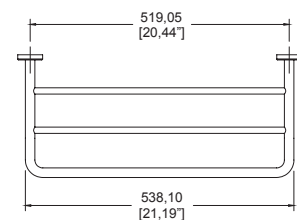

Dimensiones:
vista frontal

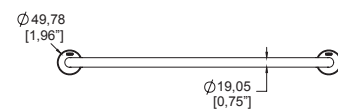

Acabado.

AU

TUBULAR AURA

TUBULAR

TUB-17-AU

Aura

\$ 1,755.00

Portapapel sencillo.



Dimensiones:
vista frontal

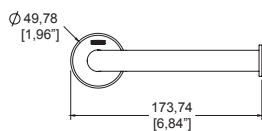

Dimensiones:
vista cenital

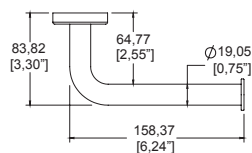

Acabado.

AU

TUBULAR

TUB-35-AU

Aura

\$ 2,633.00

Portapapel con soporte
de apoyo tipo barra
de seguridad.



Dimensiones:
vista frontal

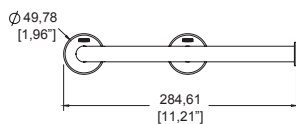

Dimensiones:
vista cenital

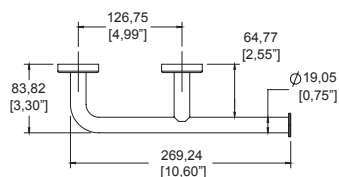

Acabado.

AU

TUBULAR OBSIDIANA



TUBULAR

TUB-05-OB

Obsidiana

\$ 2,558.00

Toallero de barra.



Dimensiones:
vista cenital

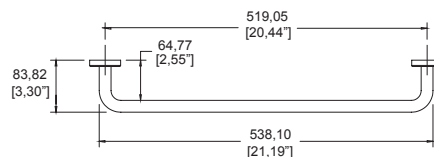

Dimensiones:
vista frontal

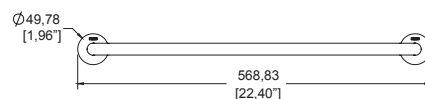

Acabado.

OB

TUBULAR

TUB-06-OB

Obsidiana

\$ 855.00

Gancho sencillo.



Dimensiones:
vista frontal

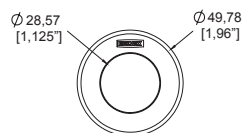

Dimensiones:
vista lateral

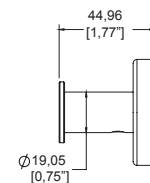

Acabado.

OB

TUBULAR
TUB-09-OB
Obsidiana

\$ 1,265.00

Toallero sencillo.



Dimensiones:
vista frontal

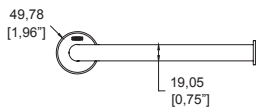

Dimensiones:
vista cenital

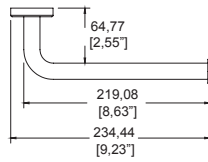

Acabado.



TUBULAR
TUB-10-OB
Obsidiana

\$ 5,126.00

Portatoallas múltiple.



Dimensiones:
vista cenital

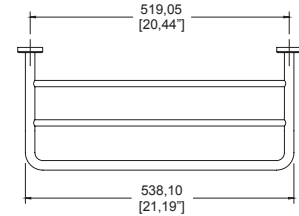

Dimensiones:
vista frontal

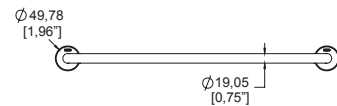

Acabado.



TUBULAR
TUB-17-EB
Obsidiana

\$ 1,755.00

Portapapel sencillo.



Dimensiones:
vista frontal

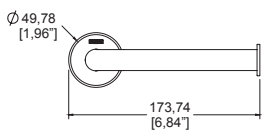

Dimensiones:
vista cenital

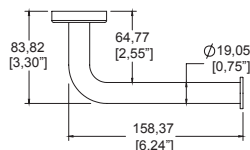

Acabado.



TUBULAR
TUB-35-EB
Obsidiana

\$ 2,633.00

Portapapel con soporte
de apoyo tipo barra
de seguridad.



Dimensiones:
vista frontal

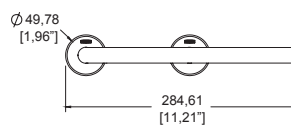

Dimensiones:
vista cenital

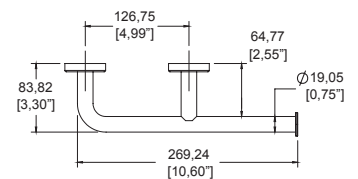

Acabado.



JABONERAS Y REPISAS DE REJILLAS

REJ-01

Cromo

\$ 1,976.00

Jabonera de rejilla rectangular.



Dimensiones:
vista frontal

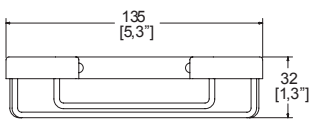

Dimensiones:
vista lateral

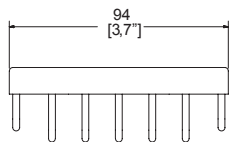

Acabado.

CR

REJ-02

Cromo

\$ 2,399.00

Repisa de rejilla esquinera.



Dimensiones:
vista cenital

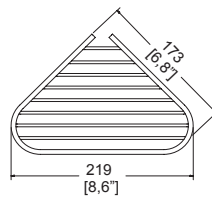

Dimensiones:
vista lateral

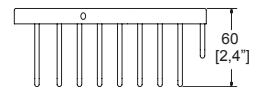

Acabado.

CR

REJ-03

Cromo

\$ 5,767.00

Repisa de rejilla semicircular doble.



Dimensiones:
vista frontal

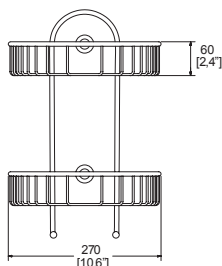

Dimensiones:
vista lateral

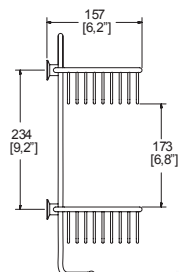

Acabado.

CR

REJ-04

Cromo

\$ 7,168.00

Repisa de rejilla rectangular doble.



Dimensiones:
vista frontal

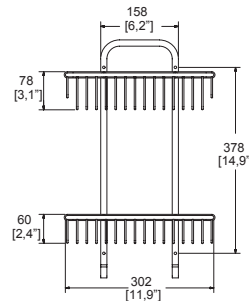

Dimensiones:
vista lateral

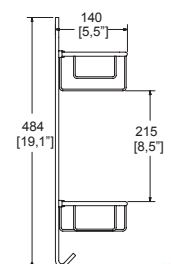

Acabado.

CR

REJ-05

Cromo

\$ 7,981.00

Repisa de rejilla esquinera doble.



Dimensiones:
vista cenital

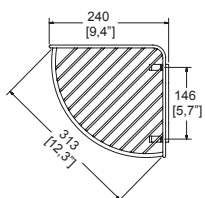

Dimensiones:
vista lateral

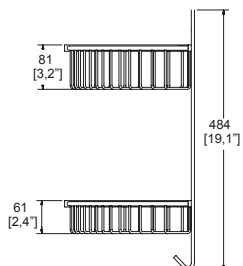

Acabado.

CR

ES-001

Cromo

\$ 5,699.00

Espejo de doble vista giratorio con aumento de **3x** en una cara.



Dimensiones:
vista frontal

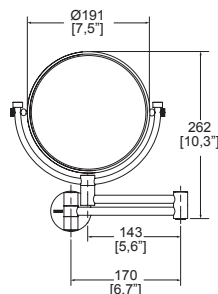

Dimensiones:
vista lateral

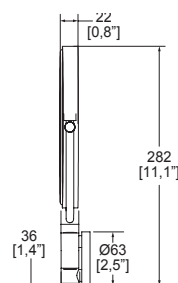

Acabado.

CR

ES-003

Cromo

\$ 7,988.00

Espejo retráctil, aumento de **5x**, con luz led, encendido y apagado con botón tipo touch.



Dimensiones:
vista frontal

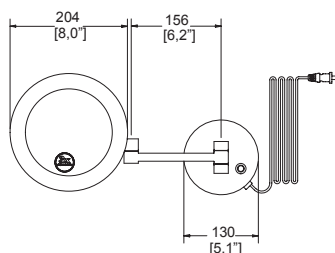

Dimensiones:
vista lateral

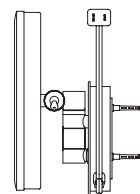

Acabado.

CR



BARRA DE SEGURIDAD Y PORTAPAPEL CON REPISA PARA CELULAR

BR-470

Cromo

Accesorio
institucional

\$ 3,099.00

Barra de seguridad
residencial
antiderrapante.



Dimensiones:
vista frontal

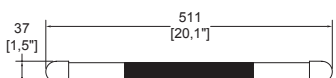

Dimensiones:
vista cenital

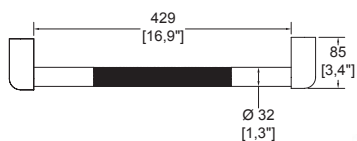

Acabado.



CR



17

Cromo

\$ 1,486.00



Dimensiones:
vista frontal

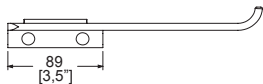

Dimensiones:
vista cenital

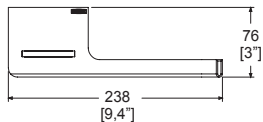

Acabado.



CR



ACABADOS



CR
Cromo



EB
Ébano



AI
Acero
Inoxidable



NI
Níquel

COCINA



Mezcladoras.



Mezcladoras con
manguera retráctil.





Monomandos.



Complementos para cocina.



Visite nuestra página web para consultar y descargar
fichas técnicas e instructivos de instalación.
helvex.com     

MEZCLADORAS Y MONOMANDOS PARA FREGADERO



CUELLO GIRATORIO



HELVEX

Garantía de Calidad



Garantía Helvex en acabado cromo de 10 años
y resto de acabados 2 años.

MEZCLADORAS PARA COCINA

ALBATROS

HM-37

Cromo

\$ 5,215.00

Mezcladora para fregadero.



Dimensiones:
vista frontal

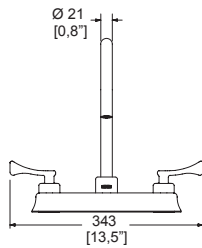

Dimensiones:
vista lateral

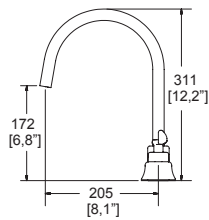

Cuello giratorio
Presión mínima requerida 0.25 kg/cm².



FLAMINGO

HM-38

Cromo

\$ 5,215.00

Mezcladora para fregadero.



Dimensiones:
vista frontal

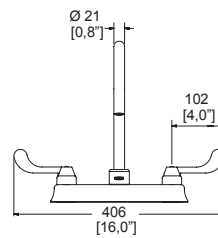

Dimensiones:
vista lateral

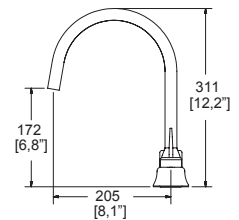

Cuello giratorio.
Presión mínima requerida 0.25 kg/cm².



TRITÓN

ME-302

Cromo

\$ 5,167.00

Mezcladora para fregadero.



Dimensiones:
vista frontal

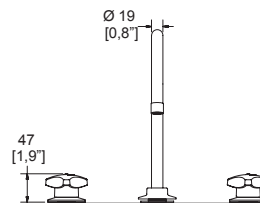

Dimensiones:
vista lateral

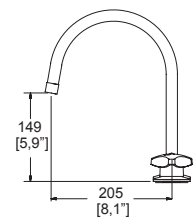

Cuello giratorio.
Presión mínima requerida 0.25 kg/cm².



MEZCLADORAS PARA COCINA

PREMIER ME-303

Cromo

\$ 9,855.00

Mezcladora para fregadero con cabezal retráctil magnético y dos tipos de chorro.

Sistema Anticalcáreo



Dimensiones:
vista frontal

Dimensiones:
vista lateral

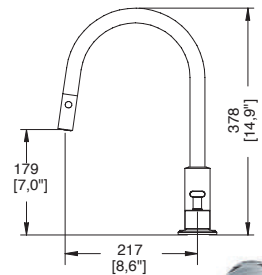
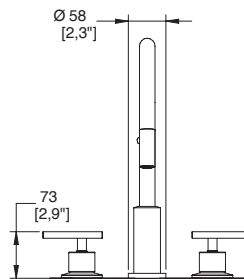

Sistema anticalcáreo

Cuello giratorio.
Presión mínima requerida 1.0 kg/cm².
Longitud de la manguera 150 cm.

CR

TIPOS DE CHORRO



Chorro 1



Chorro 2



Cabezal retráctil



MEZCLADORAS PARA COCINA

PREMIER ME-304

Cromo

\$ 8,953.00

Mezcladora para fregadero.
Cabezal movable 360°
y dos tipos de chorro.



Sistema Anticalcáreo

Dimensiones:
vista frontal

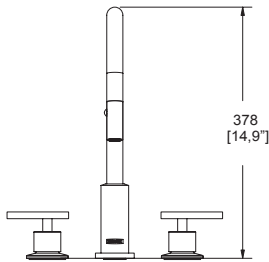

Dimensiones:
vista lateral

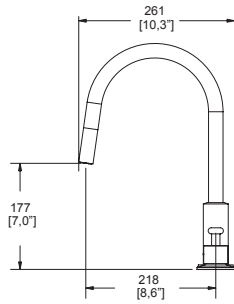

Cuello giratorio.
Presión mínima requerida 1.0 kg/cm².

CR

TIPOS DE CHORRO



Chorro 1

Chorro 2

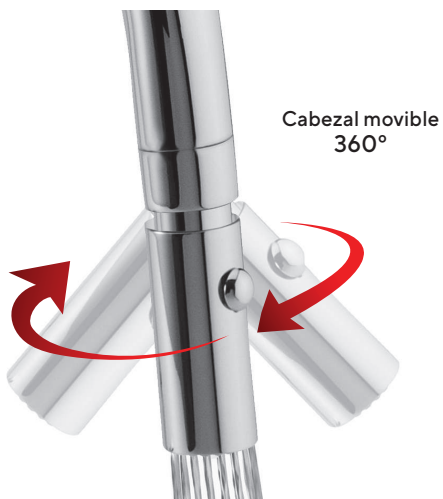

Cabezal movable
360°

Sistema anticalcáreo



MONOMANDOS PARA COCINA

NUVA

E-32-EB

Ébano

\$ 8,474.00

Monomando para fregadero.



EB

Salida giratoria.
Presión mínima requerida 0.25 kg/cm².

Dimensiones:
vista frontal

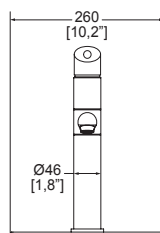

Dimensiones:
vista lateral

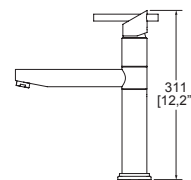

MONOMANDOS PARA COCINA

NOVUS

E-34

Cromo

\$ 5,431.00

Monomando para fregadero.



Dimensiones:
vista frontal

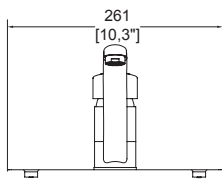

Dimensiones:
vista lateral

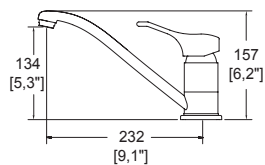

Cuello giratorio.
Presión mínima requerida 0.25 kg/cm².



CR

ERGO

E-39

Cromo

\$ 10,419.00

Monomando para fregadero con cabezal retráctil y dos tipos de chorro.



Sistema Anticalcáreo



Dimensiones:
vista frontal

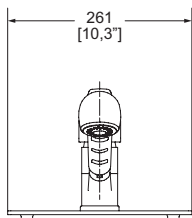

Dimensiones:
vista lateral

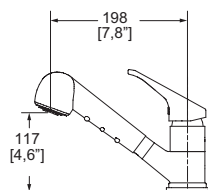

Cuello giratorio.
Presión mínima requerida 0.60 kg/cm².
Longitud de la manguera 148 cm.



CR



MONOMANDOS PARA COCINA

ELITE

E-300

Cromo

\$ 5,573.00

Monomando para fregadero.



CR

Cuello giratorio.
Presión mínima requerida 0.25 kg/cm².

ELITE

E-300-EB

Ébano

\$ 6,409.00

Monomando para fregadero.



EB

Cuello giratorio.
Presión mínima requerida 0.25 kg/cm².



Dimensiones:
vista frontal

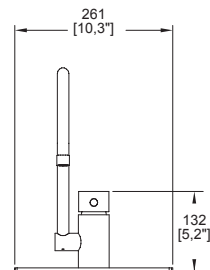

Dimensiones:
vista lateral

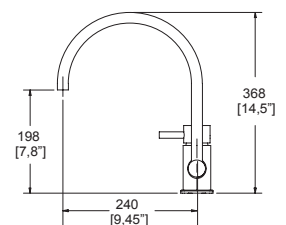

MONOMANDOS PARA COCINA

GOURMET

E-305

Cromo

\$ 15,377.00

Monomando profesional para fregadero, con resorte y dos tipos de chorro.



Sistema Anticalcáreo



Dimensiones:
vista frontal

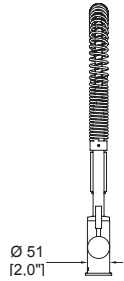

Dimensiones:
vista lateral

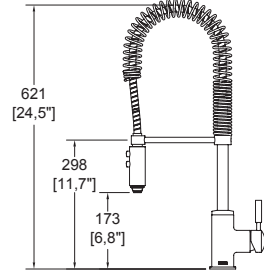

Cuello giratorio.
Presión mínima requerida 1.00 kg/cm².
Longitud de la manguera 61 cm.

CR

TIPOS DE CHORRO



Sistema anticalcáreo

PALMA

E-306

Cromo

\$ 13,260.00

Monomando para fregadero cabezal retráctil, con dos tipos de chorro.



Sistema Anticalcáreo



Dimensiones:
vista frontal

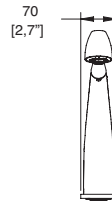

Dimensiones:
vista lateral

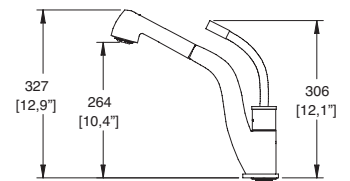

Cuello giratorio.
Presión mínima requerida 0.60 kg/cm².
Longitud de la manguera 148 cm.



CR

TIPOS DE CHORRO



Sistema anticalcáreo

MONOMANDOS PARA COCINA

CURVO

E-307

Cromo

\$ 12,384.00

Monomando para fregadero. Cabezal retráctil magnético con dos tipos de chorro.



Sistema Anticalcáreo



Dimensiones:
vista frontal

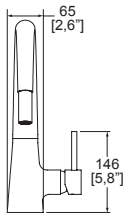

Dimensiones:
vista lateral

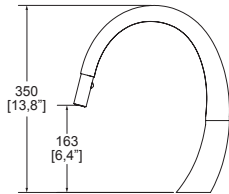

Cuello giratorio.
Presión mínima requerida 1.00 kg/cm².
Longitud de la manguera 150 cm.



CR

TIPOS DE CHORRO



GOURMET TWIN

E-308

Cromo

\$ 17,235.00

Monomando profesional
doble para fregadero,
cabezal con dos tipos de
chorro.



**Sistema
Anticalcáreo**



Dimensiones:
vista frontal

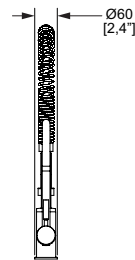

Dimensiones:
vista lateral

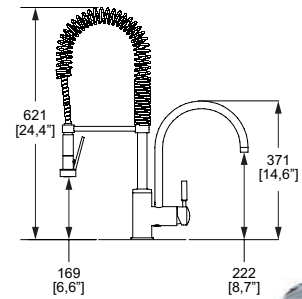

Cuello giratorio.
Presión mínima requerida 1.00 kg/cm².
Longitud de la manguera 61 cm.



CR

TIPOS DE CHORRO



MONOMANDOS PARA COCINA

DORIA

E-309

Cromo

\$ 7,889.00

Monomando para fregadero con dos tipos de chorro, con cabezal movable 360°.



Dimensiones:
vista frontal

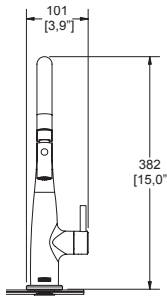

Dimensiones:
vista lateral

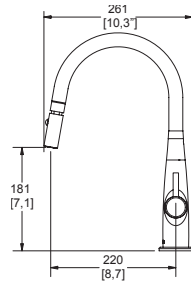

Incluye kit cubretaladros.
Cuello giratorio.
Presión mínima requerida 1.0 kg/cm².



CR



MONOMANDOS PARA COCINA

DORIA

E-310

Cromo

\$ 6,978.00

Monomando para fregadero sencillo de chorro fijo.



Incluye kit cubretaladros.

Cuello giratorio.

Presión mínima requerida 0.60 kg/cm².

CR

DORIA

E-310-EB

Ébano

\$ 8,024.00

Monomando para fregadero sencillo de chorro fijo.



Incluye kit cubretaladros.

Cuello giratorio.

Presión mínima requerida 0.60 kg/cm².

EB

Dimensiones:
vista frontal

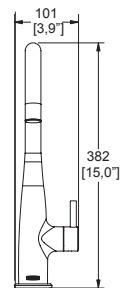

Dimensiones:
vista lateral

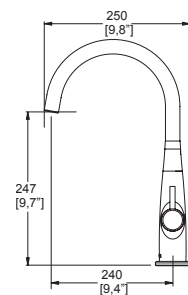

MONOMANDOS PARA COCINA

ADARA

E-312

Cromo

\$ 9,452.00

Monomando para fregadero, cabezal retráctil con dos tipos de chorro.



Dimensiones:
vista frontal

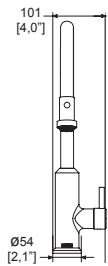

Dimensiones:
vista lateral

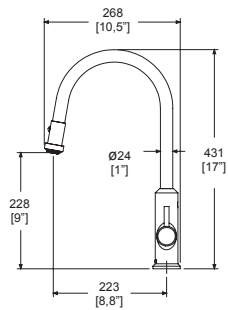

Incluye kit cubretaladros.
Cuello giratorio.
Presión mínima requerida 1.0 kg/cm².

CR



CONTRACANASTA PARA FREGADERO

H-8801

Acero inoxidable

\$ 2,413.00

Contracanasta para fregadero.



Dimensiones:
vista frontal

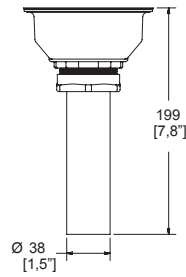

Dimensiones:
vista cenital

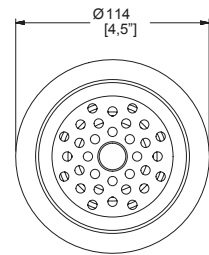

Acabado.



H-8802

Acero inoxidable

\$ 1,476.00

Contracanasta para fregadero con canastilla removible.



Dimensiones:
vista frontal

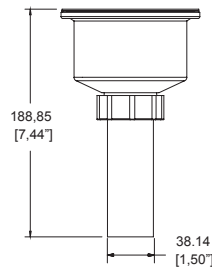

Dimensiones:
vista cenital

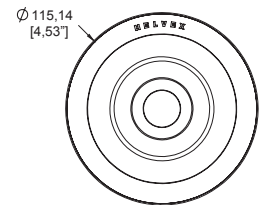

Cuerpo de polipropileno.
Tapa y canastilla de acero inoxidable.



COMPLEMENTOS PARA COCINA

TV-012

Cromo

\$ 807.00

Válvula de paso roscable.

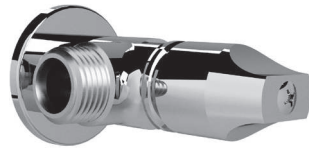

Dimensiones: vista frontal

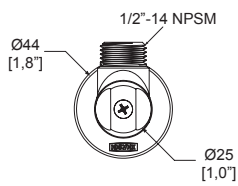

Dimensiones: vista lateral

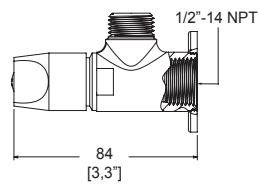

100% latón.
Para instalarse en lavabo, fregadero y WC.

CR

TV-030

Cromo

\$ 2,481.00

Césped para fregadero con registro.



Dimensiones: vista frontal

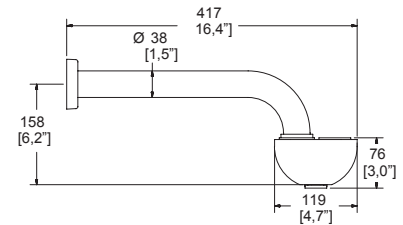

Dimensiones: vista cenital

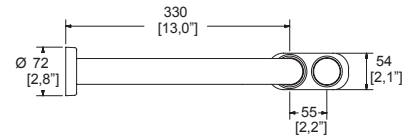

Acabado.

CR

TV-031

Níquel

\$ 2,220.00

Conexión para céspol.
Tarja doble.



Dimensiones: vista frontal

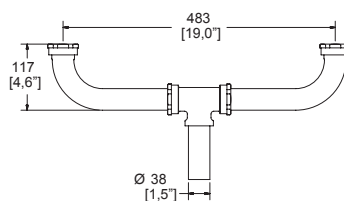

Dimensiones: vista lateral

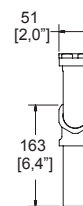

Acabado.

NI

ACABADOS



CR
Cromo



EB
Ébano



AU
Aura



OB
Obsidiana

REGADERAS



Chorro fijo.



Chorro regulable.



Tecnología Aireavex.



Switch.



Plato ancho
y gran formato.



Regaderas de altura
deslizable.

Tecnologías innovadoras y certificaciones:



Tecnología que proporciona una sensación de abundancia a través de un chorro burbujeante. Aumenta un 20% el chorro de agua y se ahorra un 10% de agua.



Distintivo de la CONAGUA para productos que ahorran agua.



Premio EcoCihac a algunos de nuestros productos por su tecnología ahorradora de agua.



Todas nuestras regaderas cumplen con la Norma Oficial Mexicana NOM-008-CONAGUA-1998 "Regaderas Empleadas en el Aseo Corporal-Especificaciones y Métodos de Prueba"

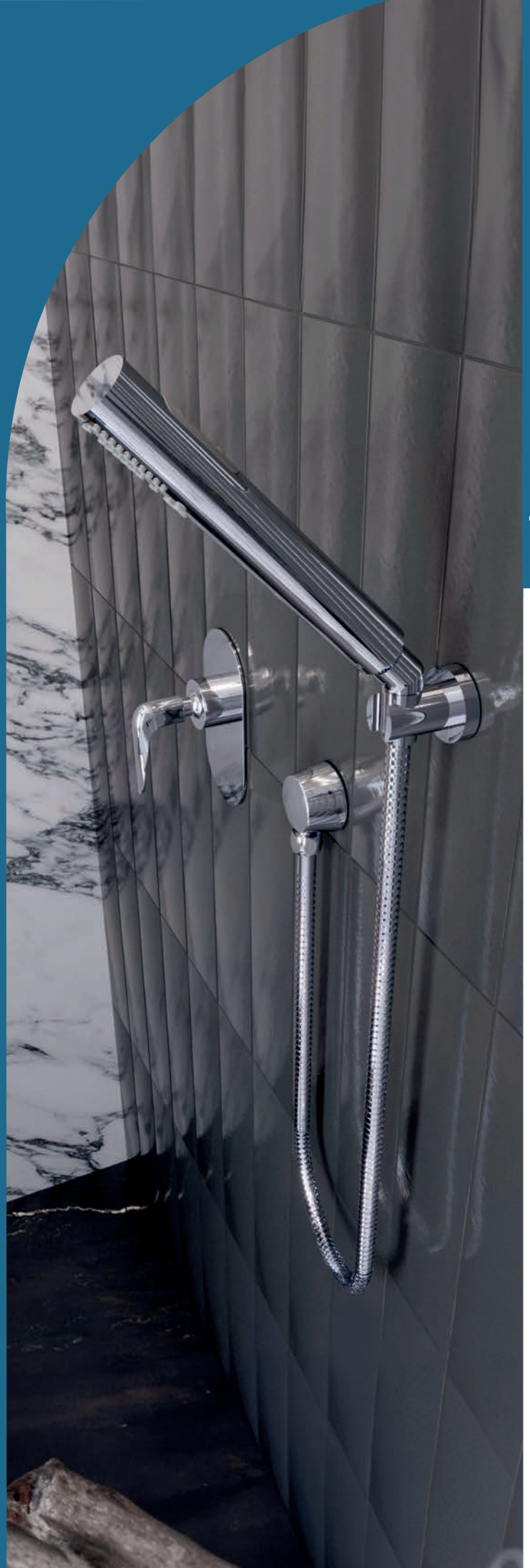

Visite nuestra página web para consultar y descargar fichas técnicas e instructivos de instalación.
helvex.com     

REGADERAS

DIVERSIDAD DE ESTILOS: CHORRO FIJO, MULTICHORRO, GRAN FORMATO, PLATO ANCHO Y MANUALES.

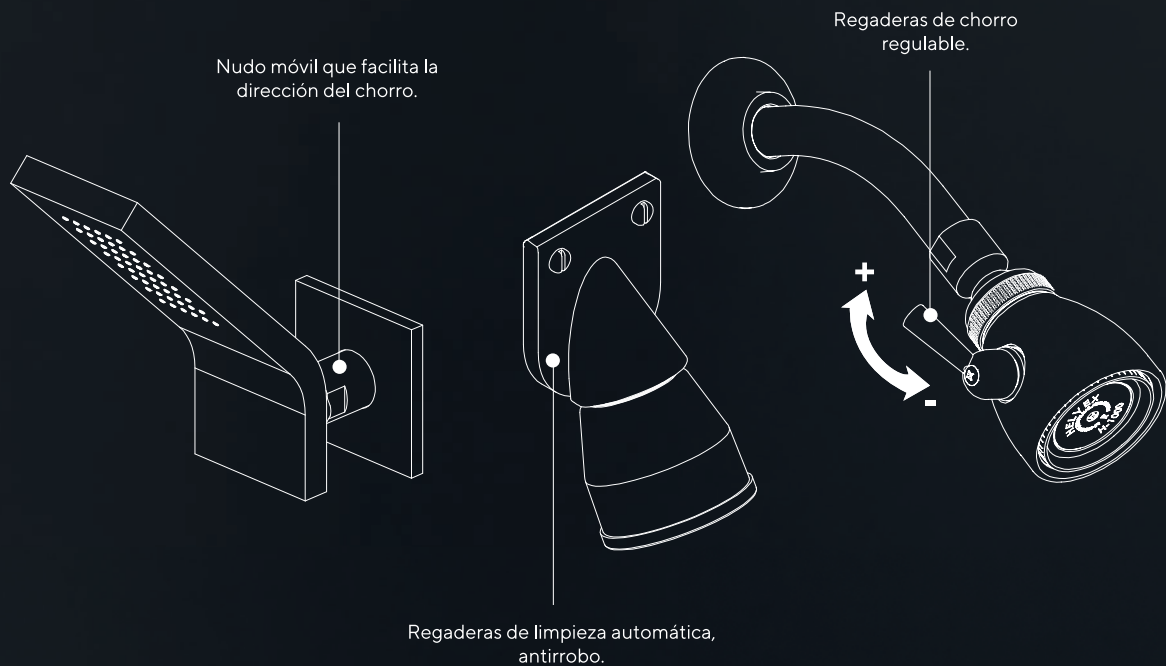

Garantía Helvex en acabado cromo de 10 años y resto de acabados 2 años.



ECOLVEX

Regaderas con uso eficiente de agua.



Todas nuestras regaderas cuentan con tecnología Aireavex.



Fácil limpieza, gracias a su sistema anticálcico.

HELVEX

Garantía de Calidad

REGADERAS DE CHORRO FIJO

H-100

Cromo

\$ 2,365.00

Regadera de chorro fijo.

 **Modelo ahorrador H100-6**



NUDO MÓVIL



Dimensiones:
vista inferior

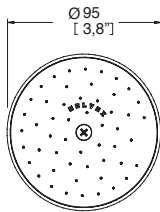

Dimensiones:
vista lateral

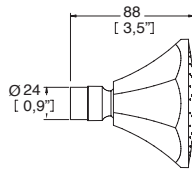

Presión mínima requerida 0.20 kg/cm².
Consumo máximo de agua: 10 L/min.

CR

KONOS

H-102

Cromo

\$ 1,096.00

Regadera de chorro fijo.



NUDO MÓVIL



Dimensiones:
vista inferior

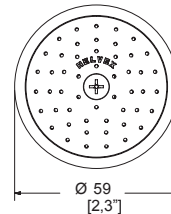

Dimensiones:
vista lateral

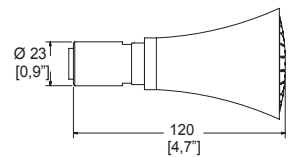

Presión mínima requerida 0.20 kg/cm².
Consumo máximo de agua: 10 L/min.

CR

H-105

Cromo

\$ 3,771.00

Regadera de chorro fijo.



NUDO MÓVIL



Dimensiones:
vista inferior

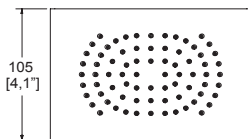

Dimensiones:
vista lateral

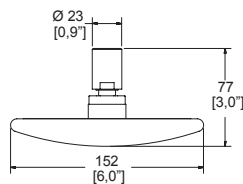

Presión mínima requerida 0.20 kg/cm².
Consumo máximo de agua: 10 L/min.

 **Sistema Anticalcáreo**

CR

ÓPTIMA

H-200

Cromo

\$ 1,427.00

Regadera de chorro fijo.
Incluye brazo y chapetón.

 **Modelo ahorrador H200-6**



NUDO MÓVIL



Dimensiones:
vista frontal

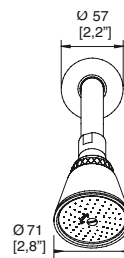

Dimensiones:
vista lateral

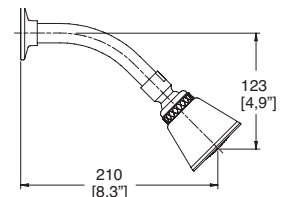

Presión mínima requerida 0.20 kg/cm².
Consumo máximo de agua: 10 L/min.

 **Sistema Anticalcáreo**

CR

NOM NOM-008-CONAGUA-1998

REGADERAS DE CHORRO FIJO

EXPLORA

H-201

Cromo

\$1,656.00

Regadera de chorro fijo.
Incluye brazo y chapetón.

 **Modelo ahorrador
H201-6**



Dimensiones:
vista frontal

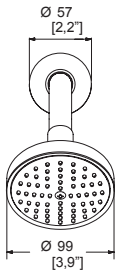

Dimensiones:
vista lateral

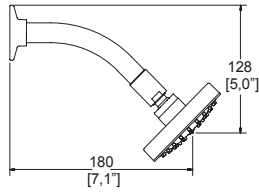

Presión mínima requerida 0.20 kg/cm².
Consumo máximo de agua: 10 L/min.



EXPLORA

H-201-AU

Aura

\$1,904.00

Regadera de chorro fijo.
Incluye brazo y chapetón.

**NUEVO
ACABADO**



Dimensiones:
vista frontal

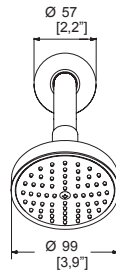

Dimensiones:
vista lateral

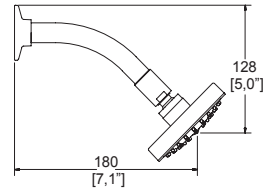

Presión mínima requerida 0.20 kg/cm².
Consumo máximo de agua: 10 L/min.



EXPLORA

H-201-EB

Ébano

\$1,904.00

Regadera de chorro fijo.
Incluye brazo y chapetón.



NUDO MÓVIL



Dimensiones:
vista frontal

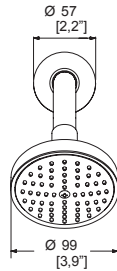

Dimensiones:
vista lateral

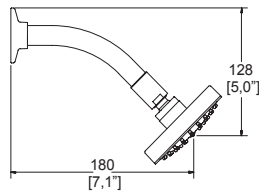

Presión mínima requerida 0.20 kg/cm².
Consumo máximo de agua: 10 L/min.



EXPLORA

H-201-OB

Obsidiana

\$1,904.00

Regadera de chorro fijo.
Incluye brazo y chapetón.

**NUEVO
ACABADO**

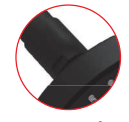

NUDO MÓVIL



Dimensiones:
vista frontal



Dimensiones:
vista lateral

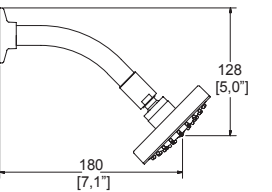

Presión mínima requerida 0.20 kg/cm².
Consumo máximo de agua: 10 L/min.



NOM NOM-008-CONAGUA-1998

REGADERAS DE CHORRO FIJO

IGUAZÚ

H-202

Cromo

\$ 1,578.00

Regadera de chorro vigorizante.
Incluye brazo y chapetón.



Dimensiones:
vista frontal

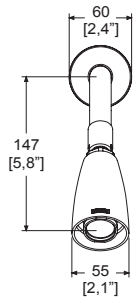

Dimensiones:
vista lateral

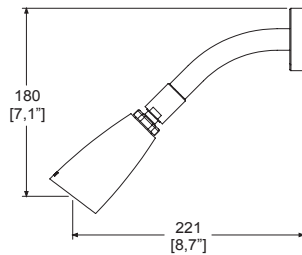

CR

Presión mínima requerida 1.5 kg/cm².
Consumo máximo de agua: 9.5 L/min.

IGUAZÚ

H-202-EB

Ébano

\$ 1,815.00

Regadera de chorro vigorizante.
Incluye brazo y chapetón.



Dimensiones:
vista frontal

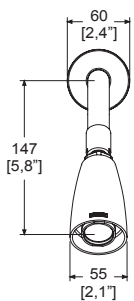

Dimensiones:
vista lateral

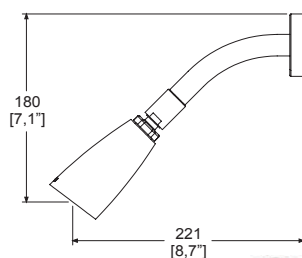

EB

Presión mínima requerida 1.5 kg/cm².
Consumo máximo de agua: 9.5 L/min.

NOM NOM-008-CONAGUA-1998



Tecnología
Aireavex



REGADERAS DE CHORRO FIJO

H-500

Cromo

\$ 1,675.00

Modelo ahorrador

H500-6

H500-8

\$ 1,724.00



Regadera de chorro fijo.



NUDO MÓVIL



Dimensiones:
vista inferior

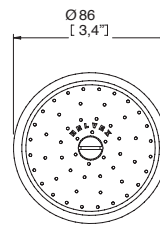

Dimensiones:
vista lateral

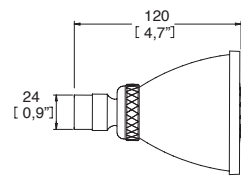

Presión mínima requerida 0.20 kg/cm².
Consumo máximo de agua: 10 L/min.



CR

H-600

Cromo

\$ 1,427.00

Regadera de chorro fijo.



NUDO MÓVIL



Dimensiones:
vista inferior

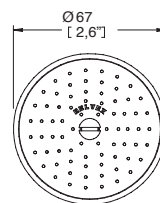

Dimensiones:
vista lateral

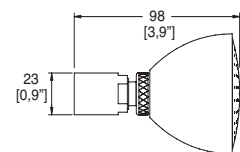

Presión mínima requerida 0.20 kg/cm².
Consumo máximo de agua: 10 L/min.



CR

NOM NOM-008-CONAGUA-1998

REGADERAS DE CHORRO FIJO

NUVA H-900

Cromo

\$ 2,960.00



Grado ecológico



NUDO MÓVIL

Regadera de chorro fijo.
Incluye brazo y chapetón.



Dimensiones:
vista frontal

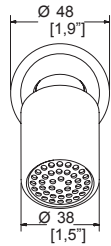

Dimensiones:
vista lateral

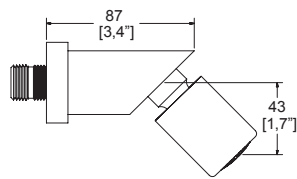

Presión mínima requerida
0.20 kg/cm².
Consumo máximo de agua:
10 L/min.



Sistema Anticalcáreo



Producto Ahorrador



CR

VÉRTIKA H-904

Cromo

\$ 4,156.00

Producto próximo a discontinuarse

Regadera de chorro fijo.
Incluye brazo y chapetón.
Con nudo móvil.

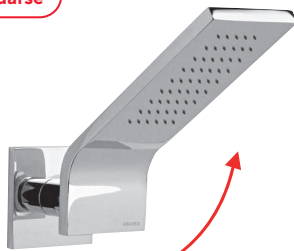

Dimensiones:
vista inferior

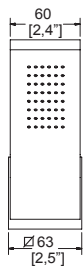

Dimensiones:
vista lateral

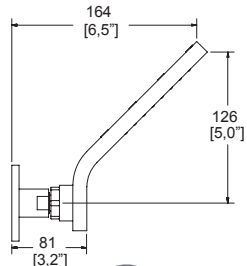

Presión mínima requerida 1.00 kg/cm².
Consumo máximo de agua: 10 L/min.



Sistema Anticalcáreo



CR

NOM NOM-008-CONAGUA-1998



AC10-TR011

Cromo

\$ 2,974.00

Regadera de limpieza automática, **con válvula de control**.
Incluye brazo y chapetón.

VÁLVULA DE CONTROL



Dimensiones:
vista frontal

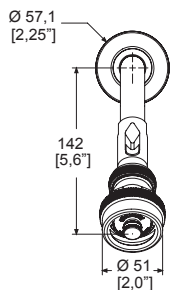

Dimensiones:
vista lateral

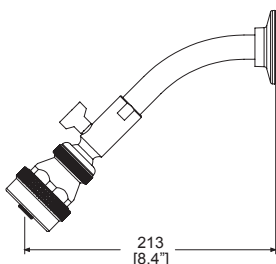

Incluye válvula de control que regula el volumen de agua.
Restringe el chorro de agua mientras te enjabonas.
No se pierde la mezcla de agua.
Presión mínima requerida 0.20 kg/cm².
Consumo máximo de agua: 10 L/min.



AC50-TR011

Cromo

\$ 2,611.00

Regadera de limpieza automática.
Sin válvula de control.
Incluye brazo y chapetón.



Dimensiones:
vista frontal

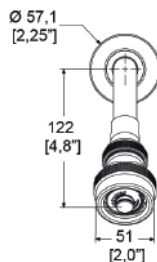

Dimensiones:
vista lateral

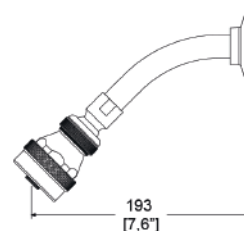

Presión mínima requerida 0.20 kg/cm².
Consumo máximo de agua: 10 L/min.



CR

AC20-TR011

Cromo

\$ 3,777.00

Regadera de limpieza automática, **con válvula de control**.
Incluye brazo y chapetón.

VÁLVULA DE CONTROL



Dimensiones:
vista frontal

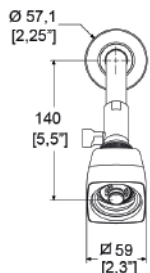

Dimensiones:
vista lateral

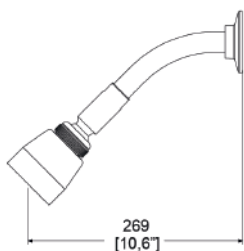

Incluye válvula de control que regula el volumen de agua.
Restringe el chorro de agua mientras te enjabonas.
No se pierde la mezcla de agua.
Presión mínima requerida 0.20 kg/cm².
Consumo máximo de agua: 10 L/min.



AC-110

Cromo

\$ 3,320.00

Regadera de limpieza automática.
Antirrobo con base al muro.



Dimensiones:
vista frontal

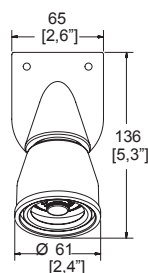

Dimensiones:
vista lateral

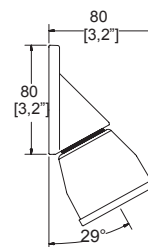

Presión mínima requerida 0.20 kg/cm².
Consumo máximo de agua: 10 L/min.



CR

REGADERAS DE LIMPIEZA AUTOMÁTICA

H1000-TR011

Cromo

\$ 3,801.00

Regadera de chorro regulable.
Incluye brazo y chapetón.



Dimensiones:
vista frontal

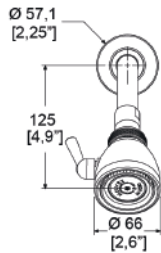

Dimensiones:
vista lateral

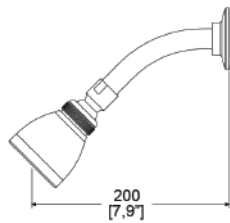

Para aumentar o disminuir el flujo de agua, gire la perilla. Incluye **palanca** que permite restringir el chorro de agua mientras te enjabonas.

No se pierde la mezcla de agua.

Presión mínima requerida 1.00 kg/cm².

Consumo máximo de agua: 10 L/min.



KÚBICA

H-3002

Cromo

\$ 10,785.00

Regadera de chorro fijo.
Plato ancho de 8".



Dimensiones:
vista inferior

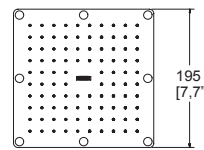

Dimensiones:
vista lateral

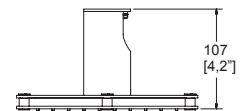

Presión mínima requerida 1.00 kg/cm².

Consumo máximo de agua: 10 L/min.



H-3003

Cromo

\$ 3,406.00

Regadera de chorro fijo.
Plato ancho de 7".



Modelo ahorrador
H3003-8



Dimensiones:
vista lateral

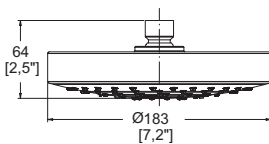

Presión mínima requerida 1.00 kg/cm².
Consumo máximo de agua: 10 L/min.



H-3004

Cromo

\$ 3,406.00

Regadera de chorro fijo.
Plato ancho de 7".



Dimensiones:
vista inferior

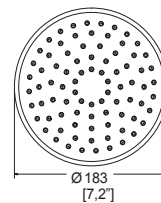

Dimensiones:
vista lateral

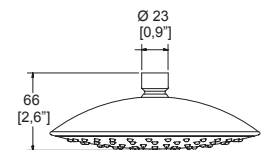

Presión mínima requerida 1.00 kg/cm².
Consumo máximo de agua: 10 L/min.



NOM NOM-008-CONAGUA-1998



REGADERAS DE PLATO ANCHO

H-3007

Cromo

\$ 10,520.00

Regadera de chorro fijo.
Plato ancho de 10".



Dimensiones:
vista inferior

Dimensiones:
vista lateral

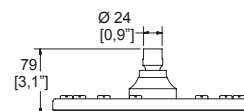
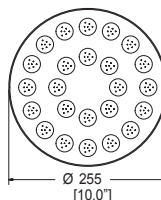

Presión mínima requerida 1.00 kg/cm².
Consumo máximo de agua: 10 L/min.



REGADERAS DE PLATO ANCHO CON TECNOLOGÍA AIREAVEX

PREMIER

H-3005

Cromo

\$ 5,723.00

Regadera de chorro fijo
con Tecnología Aireavex,
plato ancho de 5" x 8".



PREMIO **eco**
CIHAC

**Modelo ahorrador
H3005-6**

Dimensiones:
vista frontal

Dimensiones:
vista inferior

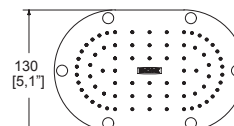
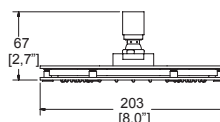

Se recomienda instalar con brazos
TR-035, TR-037 y TR-039 y con
la regadera manual de brazo largo RM-14.
Presión mínima requerida 1.00 kg/cm².
Consumo máximo de agua: 10 L/min.



**Tecnología que proporciona una
sensación de abundancia a través
de un chorro burbujeante**



**Tecnología
Aireavex**

NOM NOM-008-CONAGUA-1998

REGADERAS DE PLATO ANCHO CON TECNOLOGÍA AIREAVEX



PREMIER H3005-TR035-EB Ébano

\$ 8,437.00

Regadera de chorro fijo con Tecnología Aireavex, plato ancho de 5" x 8". Incluye brazo y chapetón.



Sistema Anticalcáreo



EB

Presión mínima requerida 1.00 kg/cm².
Consumo máximo de agua: 10 L/min.

PREMIER H3005-TR035-AU Aura

\$ 8,437.00

Regadera de chorro fijo con Tecnología Aireavex, plato ancho de 5" x 8". Incluye brazo y chapetón.



Sistema Anticalcáreo



AU

Presión mínima requerida 1.00 kg/cm².
Consumo máximo de agua: 10 L/min.

PREMIER H3005-TR035-OB Obsidiana

\$ 8,437.00

Regadera de chorro fijo con Tecnología Aireavex, plato ancho de 5" x 8". Incluye brazo y chapetón.



Sistema Anticalcáreo



OB

Presión mínima requerida 1.00 kg/cm².
Consumo máximo de agua: 10 L/min.



Dimensiones:
vista frontal

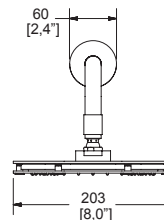

Dimensiones:
vista lateral

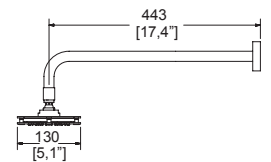

Tecnología Aireavex

NOM NOM-008-CONAGUA-1998

KÚBICA

H-3006

Cromo

\$ 7,658.00

Regadera de chorro fijo con Tecnología Aireavex, plato ancho de 6".

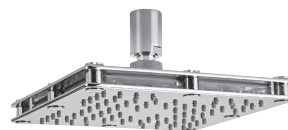

Modelo ahorrador
H3006-6

PREMIO **eco**
CIHAC

Dimensiones:
vista frontal

Dimensiones:
vista inferior

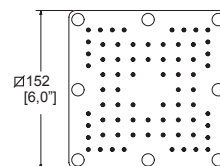
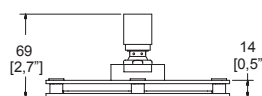

Se recomienda instalar con la regadera manual de brazo largo RM-15. Presión mínima requerida 1.00 kg/cm². Consumo máximo de agua: 9.54 L/min.



Sistema
Anticalcáreo



CR

KÚBICA

H3006-TR035-EB

Ébano

\$ 10,664.00

Regadera de chorro fijo con Tecnología Aireavex, plato ancho de 6". Incluye brazo y chapetón.



Dimensiones:
vista frontal

Dimensiones:
vista lateral

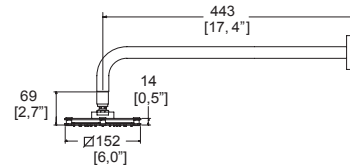
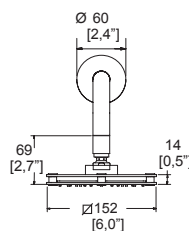

Presión mínima requerida 1.00 kg/cm². Consumo máximo de agua: 9.54 L/min.



Sistema
Anticalcáreo



EB

NOM NOM-008-CONAGUA-1998



Tecnología
Aireavex

REGADERAS DE PLATO ANCHO CON TECNOLOGÍA AIREAVEX

KÚBICA H3006-TR036-DN Duna

\$ 10,664.00

Regadera de chorro fijo con Tecnología Aireavex, plato ancho de 6". Incluye brazo y chapetón.



Dimensiones:
vista frontal

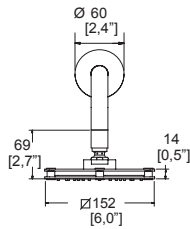

Dimensiones:
vista lateral

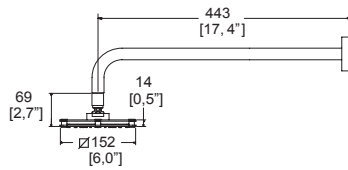

Presión mínima requerida 1.00 kg/cm².
Consumo máximo de agua: 9.54 L/min.



Sistema Anticalcáreo



DN

KÚBICA H3006-TR036-TN Titanium

\$ 10,664.00

Regadera de chorro fijo con Tecnología Aireavex, plato ancho de 6". Incluye brazo y chapetón.



Dimensiones:
vista frontal

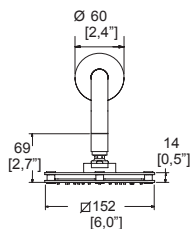

Dimensiones:
vista lateral

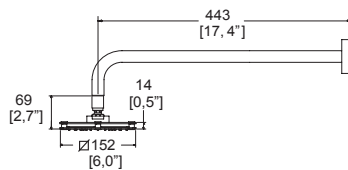

Presión mínima requerida 1.00 kg/cm².
Consumo máximo de agua: 9.54 L/min.



Sistema Anticalcáreo



TN

NOM NOM-008-CONAGUA-1998



Tecnología Aireavex

H-3008

Cromo

\$ 9,373.00

Regadera **redonda**
Plato ancho de 8"
(20 cm).
Ultraplana de chorro fijo.
Espesor: 5 mm aprox.



Dimensiones:
vista frontal

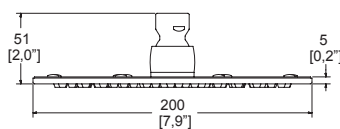

Presión mínima requerida 1.00 kg/cm².
Consumo máximo de agua: 8.7 L/min.
No incluye brazo



H-3009

Cromo

\$ 9,605.00

Regadera **cuadrada**
Plato ancho de 8" x 8"
(20 x 20 cm).
Ultraplana de chorro fijo.
Espesor: 5 mm aprox.



Dimensiones:
vista frontal

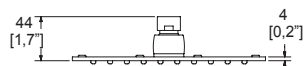

Dimensiones:
vista inferior

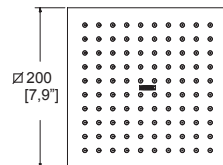

Presión mínima requerida 1.00 kg/cm².
Consumo máximo de agua: 8.7 L/min.
No incluye brazo



NOM NOM-008-CONAGUA-1998

REGADERAS DE GRAN FORMATO

H-3010

Cromo

\$ 9,405.00

Regadera **redonda**
Plato ancho 12" (**30 cm**).
Ultraplana de chorro fijo.
Espesor: 5 mm aprox.
No incluye brazo ni chapetón.



Dimensiones:
vista frontal

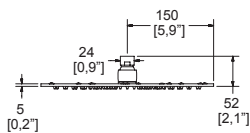

Dimensiones:
vista inferior

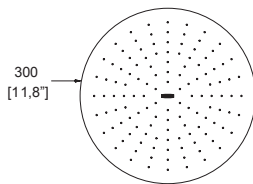

Presión mínima requerida 1.00 kg/cm².
Consumo máximo de agua: 10 L/min.



H-3011

Cromo

\$ 9,637.00

Regadera **cuadrada**
Plato ancho 12" x 12"
(**30 cm x 30 cm**).
Ultraplana de chorro fijo
Espesor: 5 mm aprox.
No incluye brazo ni chapetón.



Dimensiones:
vista frontal

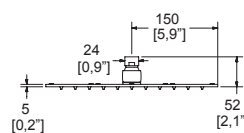

Dimensiones:
vista inferior

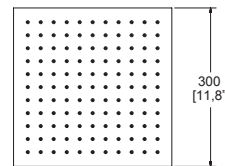

Presión mínima requerida 1.00 kg/cm².
Consumo máximo de agua: 10 L/min.



H-3013

Cromo

\$ 14,701.00

Regadera **cuadrada**
Plato ancho 16" x 16"
(**40 cm x 40 cm**).
Ultraplana de chorro fijo.
Espesor: 10 mm aprox.
No incluye brazo ni chapetón.



Dimensiones:
vista frontal

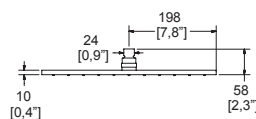

Dimensiones:
vista inferior

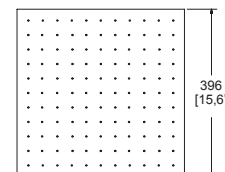

Presión mínima requerida 1.00 kg/cm².
Consumo máximo de agua: 10 L/min.



NOM NOM-008-CONAGUA-1998

Los precios incluyen IVA

137

HELVEX
Garantía de Calidad



H-3300

Cromo

\$ 2,298.00

Regadera multichorro 5"
Con **botón** de cambios
en el plato para
3 tipos de sensaciones
(Lluvia fina, lluvia gruesa
y masaje).
Incluye brazo y chapetón.



Dimensiones:
vista frontal

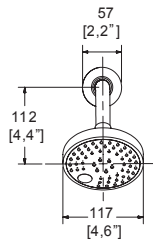

Dimensiones:
vista lateral

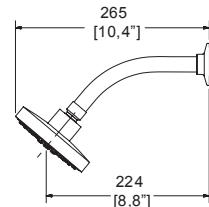

Presión mínima requerida 1.00 kg/cm².
Consumo máximo de agua: 10 L/min.

**Sistema
Anticalcáreo**

CR

TIPOS DE CHORRO

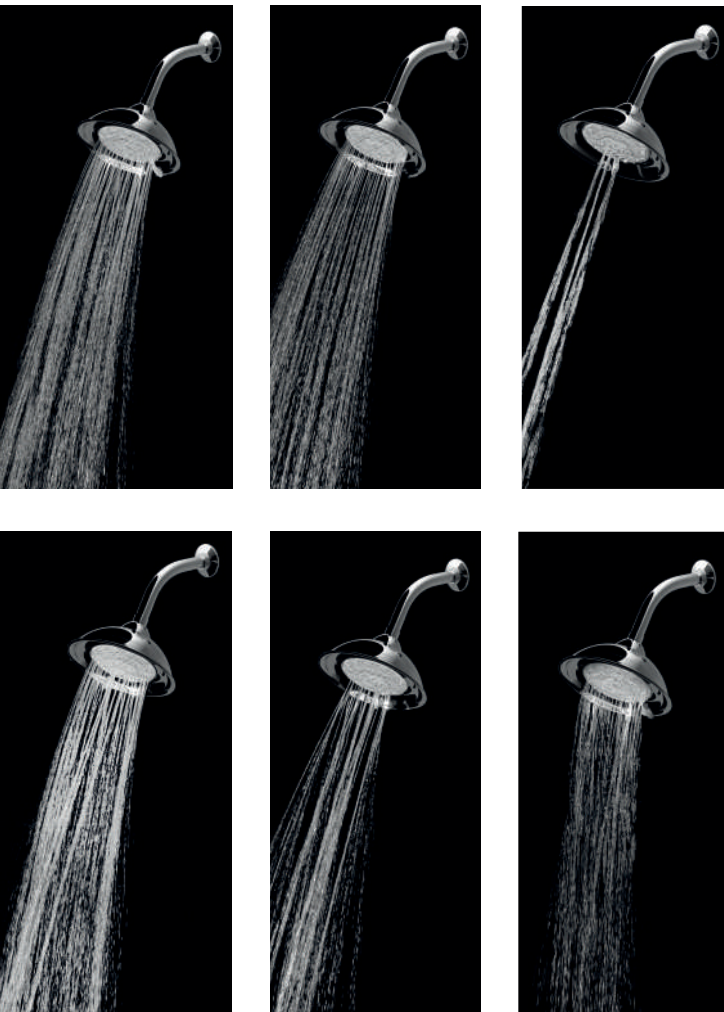

H-3301-C/G

Cromo y plato gris

\$ 2,824.00

Regadera multichorro 7"
Con **palanca** de cambios
en el plato para
6 tipos de sensaciones
(Libera, activa, disfruta,
relaja, despierta y fusiona).
Incluye brazo y chapetón.



Dimensiones:
vista frontal

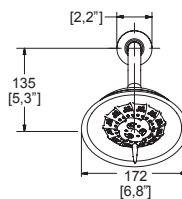

Dimensiones:
vista lateral

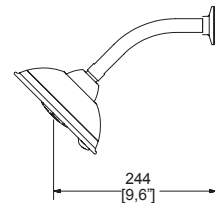

Presión mínima requerida 1.00 kg/cm².
Ahorradora de agua.
Consumo máximo de agua: 10 L/min.

**Sistema
Anticalcáreo**

C/G

NOM NOM-008-CONAGUA-1998

REGADERAS SWITCH

H-3302

Cromo

\$ 3,976.00



CR



H-3302-C/B

Cromo/blanco

\$ 3,976.00



C/B



Regadera **redonda** multichorro de plato ancho 10" x 10". Con **botón** de cambios en el plato para **3 tipos de sensaciones** (Relaja, fusiona y activa). Incluye brazo angular 90° y chapetón.

Presión mínima de funcionamiento: 1.00 kg/cm².
Consumo máximo de agua: 10 L/min.



Sistema Anticalcáreo

H-3303

Cromo

\$ 3,976.00



CR



H-3303-C/B

Cromo/blanco

\$ 3,976.00



C/B



Regadera **cuadrada** multichorro de plato ancho 10" x 10". Con **botón** de cambios en el plato para **3 tipos de sensaciones** (Relaja, fusiona y activa). Incluye brazo angular 90° y chapetón.

Presión mínima de funcionamiento: 1.00 kg/cm².
Consumo máximo de agua: 10 L/min.



Sistema Anticalcáreo

Dimensiones:
vista frontal

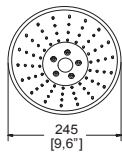

Dimensiones:
vista lateral

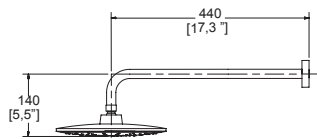

Dimensiones:
vista frontal

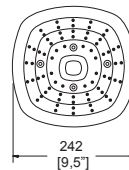

Dimensiones:
vista lateral

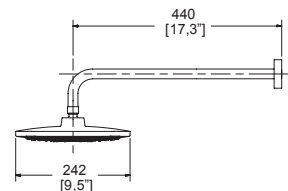

TIPOS DE CHORRO



NOM NOM-008-CONAGUA-1998

TR-011

Cromo

\$ 632.00

Brazo y chapetón para regadera.



Dimensiones:
vista frontal

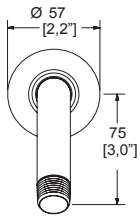

Dimensiones:
vista lateral

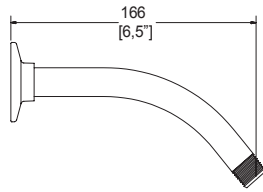

Acabado.



TR-012

Cromo

\$ 695.00

Brazo y chapetón para regadera.



Dimensiones:
vista frontal

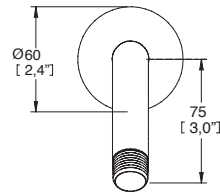

Dimensiones:
vista lateral

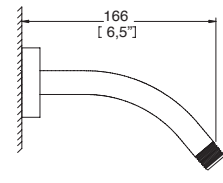

Acabado.



TR-013

Cromo

\$ 805.00

Brazo y chapetón cuadrado para regadera.



Dimensiones:
vista frontal

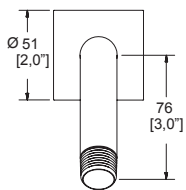

Dimensiones:
vista lateral

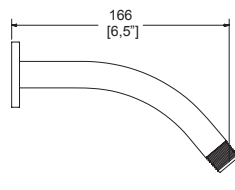

Acabado.



TR-035

Cromo

\$ 1,580.00

Brazo y chapetón angular para regadera de plato ancho.



Dimensiones:
vista lateral

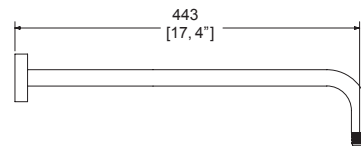

Dimensiones:
vista frontal

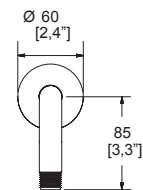

Acabado.



BRAZOS Y CHAPETONES

TR-036

Cromo

\$ 2,258.00

Brazo y chapetón cuadrado para regadera de plato ancho.

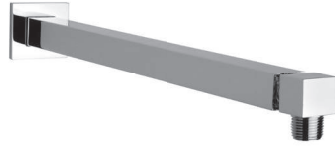

Dimensiones:
vista frontal

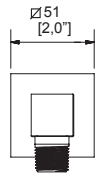

Dimensiones:
vista lateral

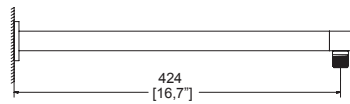

Acabado.



CR

TR-037

Cromo

\$ 1,508.00

Brazo y chapetón al techo redondo para regadera.



Dimensiones:
vista frontal

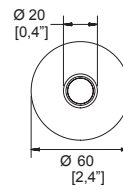

Dimensiones:
vista lateral

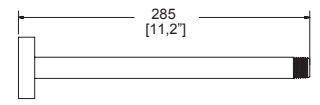

Acabado.



CR

TR-038

Cromo

\$ 1,998.00

Brazo y chapetón al techo cuadrado para regadera.



Dimensiones:
vista frontal

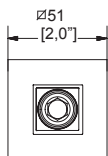

Dimensiones:
vista lateral

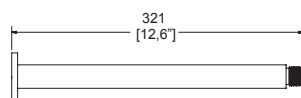

Se recomienda para las regaderas de plato ancho H-3002, H-3006 y H-3009.



CR

TR-039

Cromo

\$ 2,595.00

Brazo y chapetón angular para regadera.



Dimensiones:
vista frontal



Dimensiones:
vista lateral

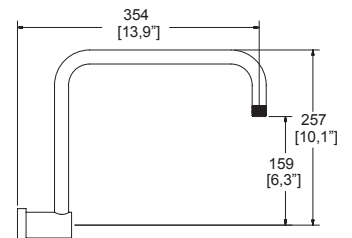

Aumenta la altura de la regadera.



CR

FUTURA

RM-7

Cromo

\$ 7,396.00

Regadera manual con desviador.

 **Modelo ahorrador**
RM7-6



Dimensiones:
vista frontal

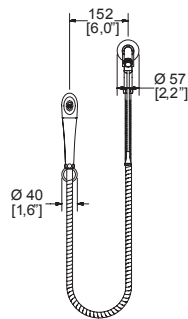

Dimensiones:
vista lateral

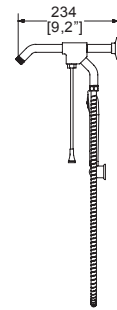

Presión mínima requerida 0.20 kg/cm².

Consumo máximo de agua: 10 L/min.

Longitud de la manguera 150 cm.



RM-14

Cromo

\$ 7,396.00

Regadera manual con desviador y brazo angular redondo para regaderas de plato ancho.



Dimensiones:
vista frontal

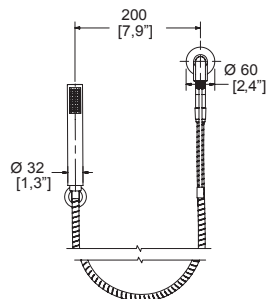

Dimensiones:
vista lateral

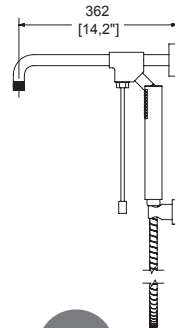

Presión mínima requerida 1.00 kg/cm².

Consumo máximo de agua: 10 L/min.

Longitud de la manguera 150 cm.



Sistema
Anticalcáreo



NOM NOM-008-CONAGUA-1998

REGADERAS MANUALES

RM-15

Cromo

\$ 7,396.00

Regadera manual con **3 tipos de chorro** (Rocío, lluvia fina, lluvia gruesa) desviador y brazo angular, chapetón cuadrado para regaderas de plato ancho.

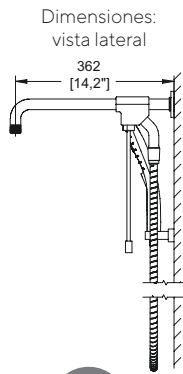
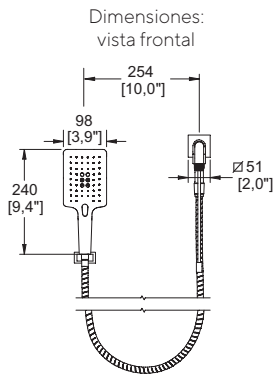

Presión mínima requerida 1.00 kg/cm².
Consumo máximo de agua: 10 L/min.
Regadera manual: 8.7 L/min.
Longitud de la manguera 150 cm.



Sistema Anticalcáreo



CR

FUTURA II

RM-17

Cromo

\$ 7,396.00

Regadera manual con desviador.

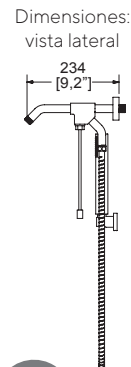
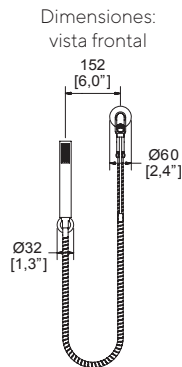

Presión mínima requerida 0.20 kg/cm².
Consumo máximo de agua: 10 L/min.
Longitud de la manguera 150 cm.



Sistema Anticalcáreo



CR



NUVA

RM12-H101

Cromo

\$ 7,396.00

Regadera manual con desviador.
Incluye regadera fija.

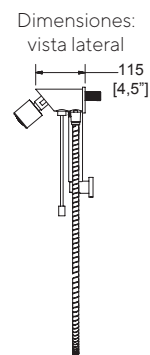
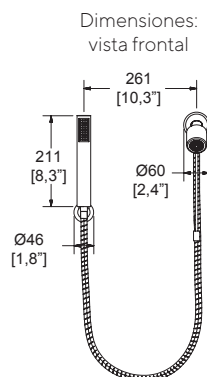

Presión mínima requerida 0.20 kg/cm².
Consumo máximo de agua: 10 L/min.
Longitud de la manguera 150 cm.



Sistema Anticalcáreo



CR

NOM NOM-008-CONAGUA-1998

Los precios incluyen IVA

143

HELVEX
Garantía de Calidad

WHIP

RM-30

Cromo



\$ 4,238.00

Monomando para regadera o tina sin desviador.



Sistema Anticalcáreo



CR

Presión mínima requerida 1.00 kg/cm².
Consumo máximo de agua: 10 L/min.
Longitud de la manguera 150 cm.

WHIP

RM-30-EB

Ébano



\$ 4,874.00

Monomando para regadera o tina sin desviador.



Sistema Anticalcáreo



EB

Presión mínima requerida 1.00 kg/cm².
Consumo máximo de agua: 10 L/min.
Longitud de la manguera 150 cm.



Dimensiones:
vista frontal

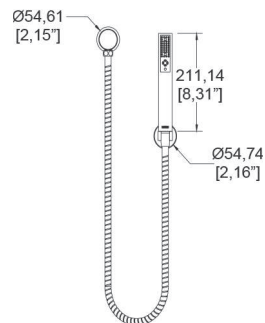

Dimensiones:
vista lateral

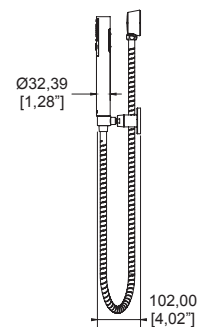

NOM NOM-008-CONAGUA-1998

REGADERAS MANUALES DE ALTURA DESLIZABLE

NUVA

RM-22

Cromo

\$ 5,812.00

Regadera manual de altura deslizable.

 **Modelo ahorrador**
RM22-6



Dimensiones:
vista frontal

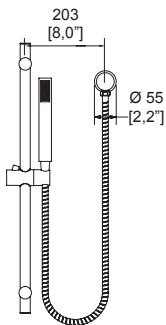

Dimensiones:
vista lateral

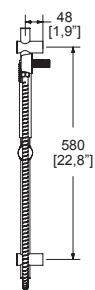

Presión mínima requerida 1.00 kg/cm².
Consumo máximo de agua: 10 L/min.
Longitud de la manguera 150 cm.

 **Sistema Anticalcáreo** 

RM-23

Cromo

\$ 6,059.00

Regadera manual de altura deslizable.

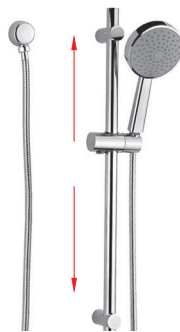

Dimensiones:
vista frontal

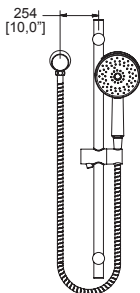

Dimensiones:
vista lateral

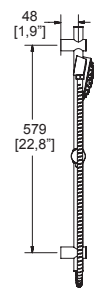

Presión mínima requerida 1.00 kg/cm².
Consumo máximo de agua: 10 L/min.
Longitud de la manguera 150 cm.

 **Sistema Anticalcáreo** 



NOM NOM-008-CONAGUA-1998

REGADERAS MANUALES DE ALTURA DESLIZABLE

RM-24

Cromo

\$ 7,192.00

Regadera manual de altura deslizable, **3 tipos de chorro** (lluvia fina, lluvia gruesa y masaje).

Dimensiones: vista frontal

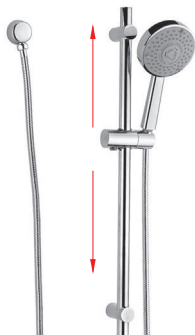
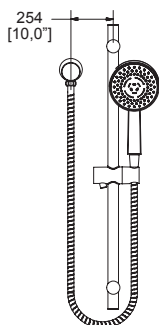

Dimensiones: vista lateral

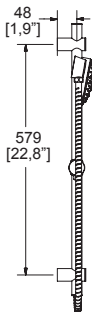

Presión mínima requerida 1.00 kg/cm².
Consumo máximo de agua: 10 L/min.
Longitud de la manguera 150 cm.



RM-27

Cromo

\$ 5,827.00

Regadera manual de altura deslizable. **5 tipos de chorro.**

Dimensiones: vista frontal

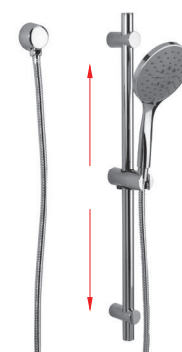
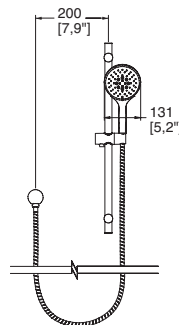

Dimensiones: vista lateral

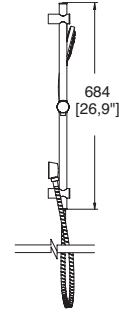

Presión mínima requerida 1.00 kg/cm².
Consumo máximo de agua: 10 L/min.
Longitud de la manguera 150 cm.



RM-28

Cromo

\$ 5,348.00

Regadera manual de altura deslizable.

Dimensiones: vista frontal

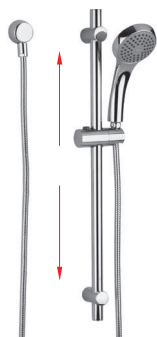
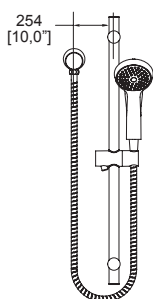

Dimensiones: vista lateral

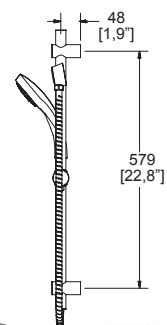

Presión mínima requerida 1.00 kg/cm².
Consumo máximo de agua: 10 L/min.
Longitud de la manguera 150 cm.



RM-29

Cromo

\$ 6,336.00

Regadera manual de altura deslizable, **5 tipos de chorro** (Rocío, lluvia fina, lluvia gruesa, champagne, masaje).

Dimensiones: vista frontal

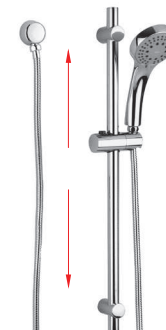
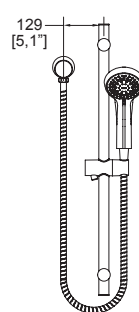

Dimensiones: vista lateral

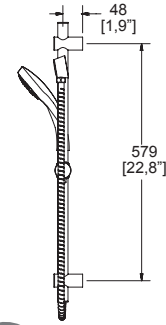

Presión mínima requerida 1.00 kg/cm².
Consumo máximo de agua: 10 L/min.
Longitud de la manguera 150 cm.



ENSAMBLES PARA REGADERA Y/O TINA

E-40

Cromo

\$ 3,468.00

Ensamble triple de empotrar para regadera y tina. Valvex de compresión.



Dimensiones: vista cenital

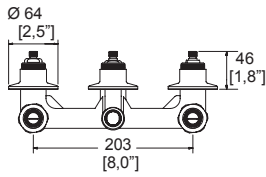

Dimensiones: vista lateral

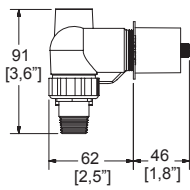

Presión mínima requerida 0.25 kg/cm².

CR

E-40-II

Cromo

\$ 3,468.00

Ensamble triple de empotrar para regadera y tina. Valvex cerámico 1/4 de vuelta.



Dimensiones: vista cenital

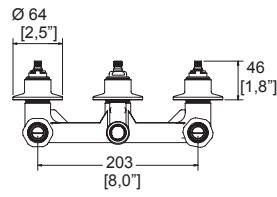

Dimensiones: vista lateral

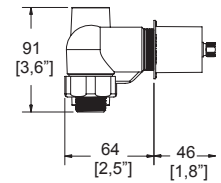

Presión mínima requerida 0.25 kg/cm².

CR

E-40-AQ

Sin chapetones

\$ 3,063.00

Ensamble triple de empotrar para regadera y tina. Valvex cerámico 1/4 de vuelta sin chapetones.



Dimensiones: vista cenital

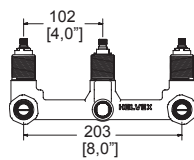

Dimensiones: vista lateral

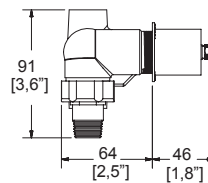

Presión mínima requerida 0.25 kg/cm².

Se surten **sin chapetones** para utilizarse con los manerales Antigua, Konos, Elegance, Nuva, Kúbica, Ática, Antares y Albatros que ya los incluyen.

E-50

Cromo

\$ 2,450.00

Ensamble triple de empotrar para regadera y tina. Valvex de compresión.



E-50-II

Cromo

\$ 2,450.00

Ensamble triple de empotrar para regadera y tina. Valvex cerámico 1/4 de vuelta.

Dimensiones:
vista cenital

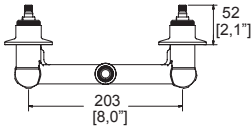

Dimensiones:
vista lateral

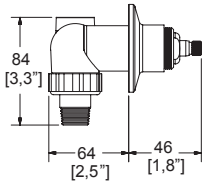

Presión mínima requerida 0.25 kg/cm².

CR

E-50-AQ

Sin chapetones

\$ 2,022.00

Ensamble triple de empotrar para regadera o tina. Valvex cerámico 1/4 de vuelta sin chapetones.



Dimensiones:
vista cenital

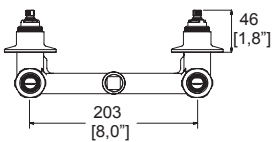

Dimensiones:
vista lateral

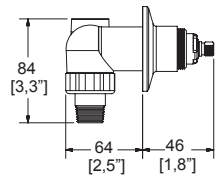

Presión mínima requerida 0.25 kg/cm².

Se surten **sin chapetones** para utilizarse con los manerales Antiqua, Konos, Elegance, Nuva, Kúbica, Ática, Antares y Albatros que ya los incluyen.

E-60

Cromo

\$ 1,390.00

Juego de ensambles individuales de empotrar para regadera. De roscar. Valvex de compresión.



E-60-II

Cromo

\$ 1,390.00

Juego de ensambles individuales de empotrar para regadera. De roscar. Valvex cerámico 1/4 de vuelta.

Dimensiones:
vista frontal

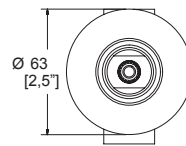

Dimensiones:
vista lateral

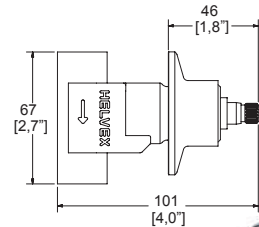

Presión mínima requerida 0.25 kg/cm².

CR

E-60-AQ

Sin chapetones

\$ 1,045.00

Juego de ensambles individuales de empotrar para regadera. De roscar. Valvex cerámico 1/4 de vuelta. Sin chapetones.



Dimensiones:
vista frontal

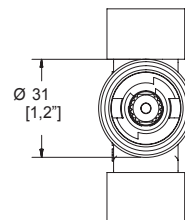

Dimensiones:
vista lateral

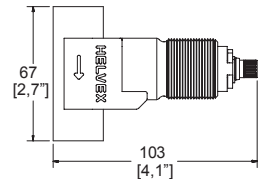

Presión mínima requerida 0.25 kg/cm².

Se surten **sin chapetones** para utilizarse con los manerales Antiqua, Konos, Elegance, Nuva, Kúbica, Ática, Antares y Albatros que ya los incluyen.

ESAMBLES PARA REGADERA Y/O TINA

E-61

Cromo

\$ 1,390.00

Juego de ensambles individuales de empotrar para regadera. De soldar. Valvex de compresión.



E-61-II

Cromo

\$ 1,390.00

Juego de ensambles individuales de empotrar para regadera. De soldar. Valvex cerámico 1/4 de vuelta.

Dimensiones:
vista frontal

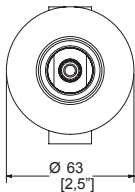

Dimensiones:
vista lateral

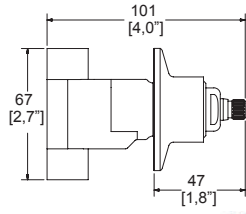

Presión mínima requerida 0.25 kg/cm².

CR

E-61-AQ

Sin chapetones

\$ 1,045.00

Juego de ensambles individuales de empotrar para regadera. De soldar. Valvex cerámico 1/4 de vuelta sin chapetones.



Dimensiones:
vista frontal

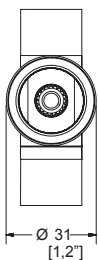

Dimensiones:
vista lateral

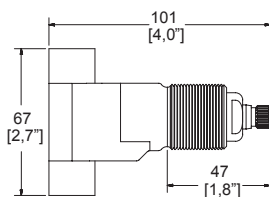

Presión mínima requerida 0.25 kg/cm².

Se surten **sin chapetones** para utilizarse con los manerales Antiqua, Konos, Elegance, Nuva, Kúbica, Ática, Antares y Albatros que ya los incluyen.

MEZCLADORAS PARA REGADERA Y/O TINA

VÉRTIKA

MR-1001

Cromo

\$ 3,665.00

Mezcladora individual de empotrar para regadera. De roscar. Incluye manerales.



Dimensiones:
vista frontal

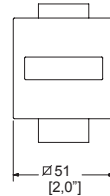

Dimensiones:
vista lateral

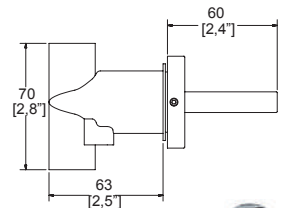

Abre a 1/4 de vuelta.

Presión mínima requerida 0.25 kg/cm².

CR

CLÁSICA

MR-1005

Cromo

\$ 2,449.00

Mezcladora individual de empotrar para regadera. De soldar. Incluye manerales.



Dimensiones:
vista cenital

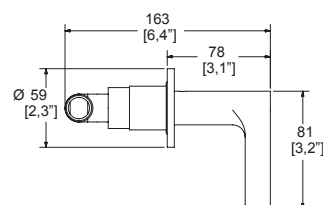

Dimensiones:
vista lateral

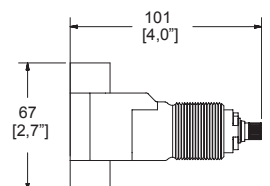

Abre a 1/4 de vuelta.

Presión mínima requerida 0.25 kg/cm².

CR

NOVUS

E-45

Cromo

\$ 4,163.00

Monomando para regadera o tina sin desviador.



Dimensiones: vista frontal

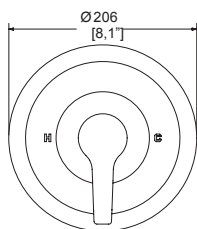

Dimensiones: vista lateral

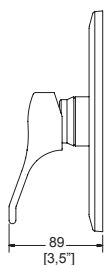

Presión mínima requerida 0.80 kg/cm².

CR

MANTISS

E-72

Cromo

\$ 4,163.00

Monomando para regadera o tina sin desviador.



Dimensiones: vista frontal

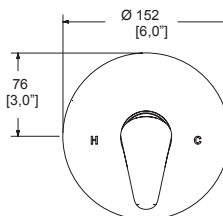

Dimensiones: vista lateral

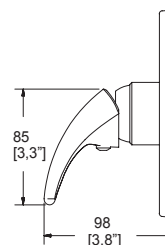

Presión mínima requerida 0.80 kg/cm².

CR

AQUA

E-77

Cromo

\$ 4,188.00

Monomando para regadera o tina sin desviador.



Dimensiones: vista frontal

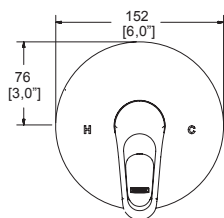

Dimensiones: vista lateral

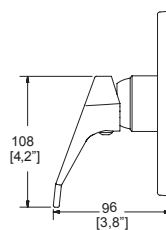

Presión mínima requerida 0.80 kg/cm².

CR

MONOMANDOS PARA REGADERA O TINA

EXPLORA

E-59

Cromo

\$ 4,081.00

Monomando para regadera o tina sin desviador.



Dimensiones:
vista frontal

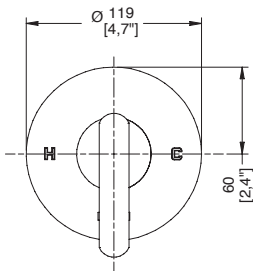

Dimensiones:
vista lateral

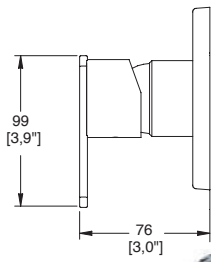

Presión mínima requerida 0.80 kg/cm².

CR

EXPLORA

E-705

Cromo

\$ 4,779.00

Monomando para regadera, tina o regadera manual con desviador.



Dimensiones:
vista frontal

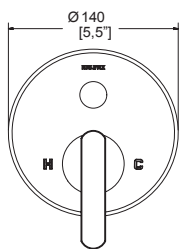

Dimensiones:
vista lateral

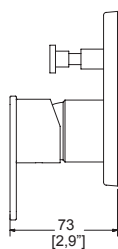

Presión mínima requerida 1.00 kg/cm².

CR

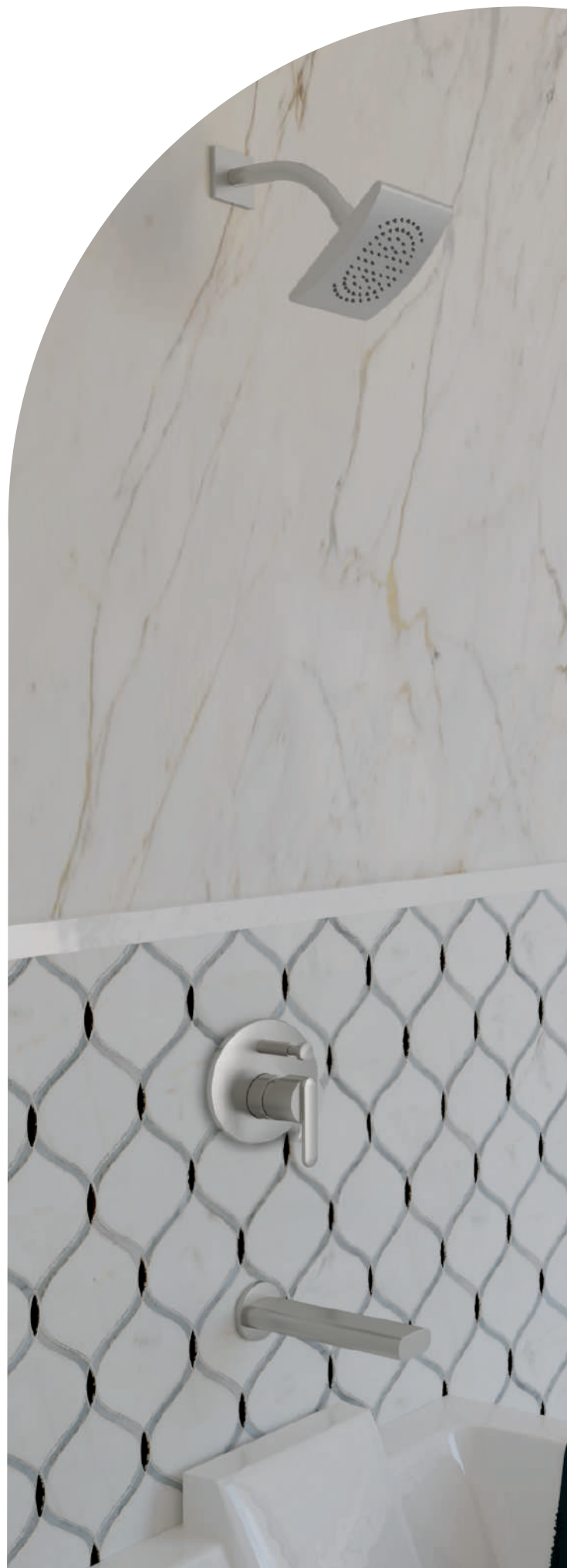

CENTURY

E-708

Cromo

\$ 3,978.00

Monomando para regadera o tina sin desviador.



CR

Presión mínima requerida 0.80 kg/cm².

CENTURY

E-708-AU

Aura

**NUEVO
PRODUCTO**

\$ 4,575.00

Monomando para regadera o tina sin desviador.

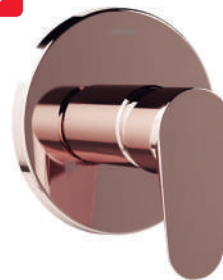

AU

Presión mínima requerida 0.80 kg/cm².

CENTURY

E-708-OB

Obsidiana

**NUEVO
PRODUCTO**

\$ 4,575.00

Monomando para regadera o tina sin desviador.



OB

Presión mínima requerida 0.80 kg/cm².

Dimensiones:
vista frontal

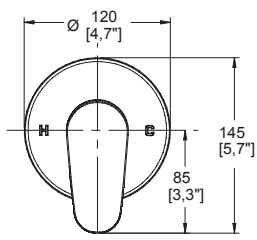

Dimensiones:
vista lateral

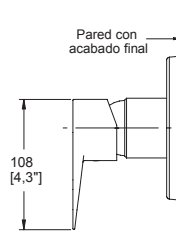

MONOMANDOS PARA REGADERA O TINA

CENTURY

E-709

Cromo

\$ 4,615.00

Monomando para regadera, tina o regadera manual con desviador.



Presión mínima requerida 0.90 kg/cm².

CR

CENTURY

E-709-AU

Aura

\$ 5,307.00

Monomando para regadera, tina o regadera manual con desviador.

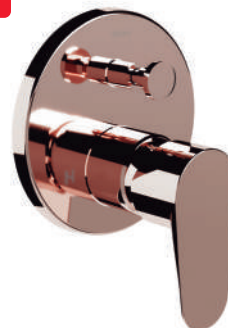

Presión mínima requerida 0.90 kg/cm².

AU

CENTURY

E-709-OB

Obsidiana

\$ 5,307.00

Monomando para regadera, tina o regadera manual con desviador.



Presión mínima requerida 0.90 kg/cm².

OB

MONOMANDO DE BALANCEO DE PRESIÓN PARA REGADERA O TINA

CENTURY

E-791

Cromo

\$ 5,986.00

Monomando de balanceo de presión para regadera, tina o regadera manual con desviador.



Producto especial, solo sobre pedido.

30 días de entrega a partir del pedido.

Presión mínima requerida 1.20 kg/cm².

CR

Dimensiones:
vista frontal

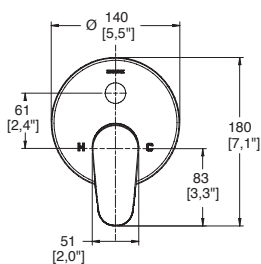

Dimensiones:
vista lateral

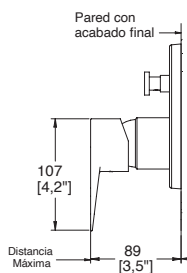

Dimensiones:
vista frontal

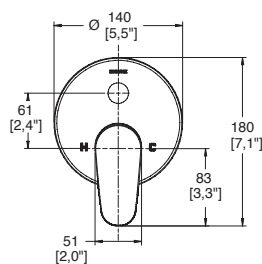

Dimensiones:
vista lateral

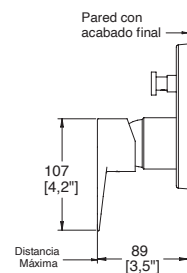

INDUS
E-717-EB

Ébano

\$ 5,335.00

Monomando para regadera o tina sin desviador.



Dimensiones:
vista frontal

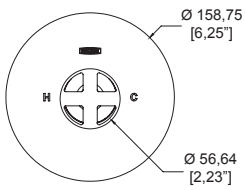

Dimensiones:
vista lateral

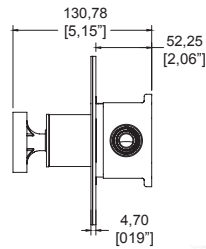

Presión mínima requerida 0.80 kg/cm².

EB

INDUS
E-718-EB

Ébano

\$ 6,030.00

Monomando para regadera o tina con desviador.



Dimensiones:
vista frontal

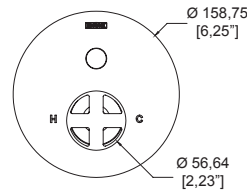

Dimensiones:
vista lateral

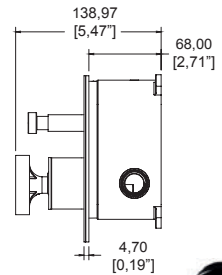

Presión mínima requerida 1.00 kg/cm².

EB

NUVA
E-46

Cromo

\$ 5,481.00

Monomando para regadera o tina sin desviador.



Dimensiones:
vista frontal

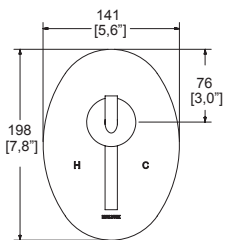

Dimensiones:
vista lateral

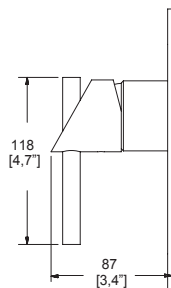

Presión mínima requerida 0.80 kg/cm².

CR

NUVA
E-47

Cromo

\$ 5,750.00

Monomando para regadera, tina o regadera manual con desviador.



Dimensiones:
vista frontal

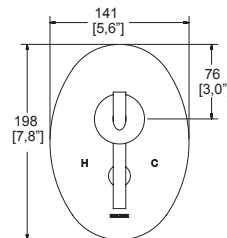

Dimensiones:
vista lateral

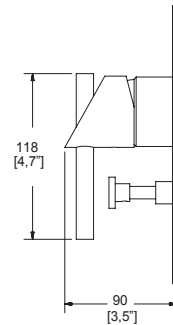

Presión mínima requerida 1.00 kg/cm².

CR

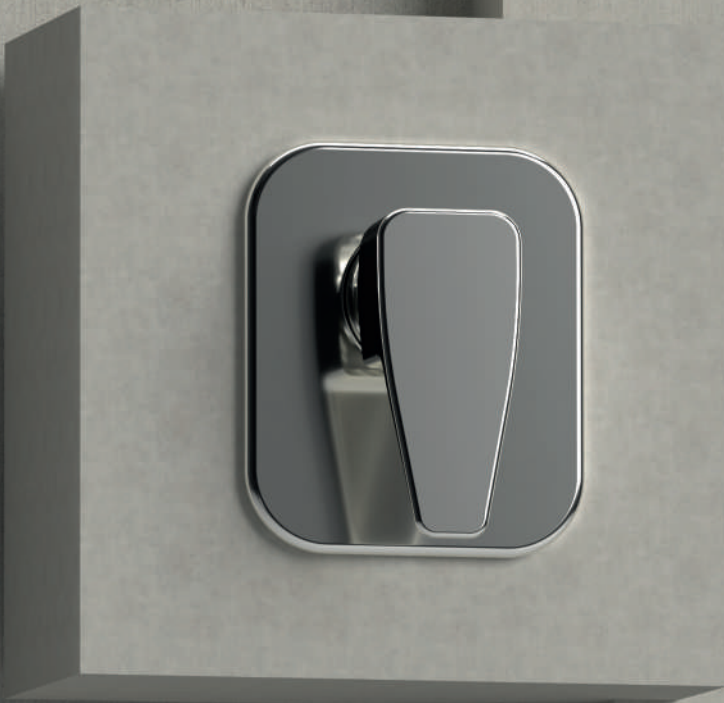

MONOMANDOS PARA REGADERA O TINA

PREMIER

E-702

Cromo

\$ 5,258.00

Monomando para regadera o tina sin desviador.



Presión mínima requerida 0.80 kg/cm².



CR

PREMIER

E-702-EB

Ébano

\$ 6,051.00

Monomando para regadera o tina sin desviador.



Presión mínima requerida 0.80 kg/cm².



EB

Dimensiones:
vista frontal

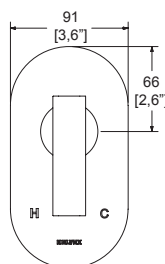

Dimensiones:
vista lateral

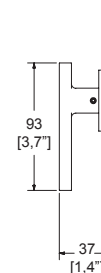

MONOMANDOS PARA REGADERA O TINA

PREMIER

E-703

Cromo

\$ 5,960.00

Monomando para regadera, tina o regadera manual con desviador.



Dimensiones: vista lateral

Dimensiones: vista frontal

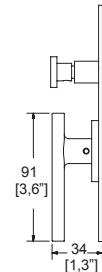
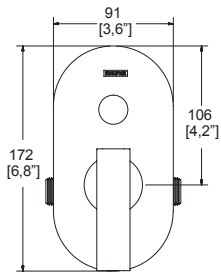

Presión mínima requerida 1.00 kg/cm².



NAUTILIA

E-714

Cromo

\$ 5,381.00

Monomando para regadera o tina, sin desviador.



Dimensiones: vista lateral

Dimensiones: vista frontal

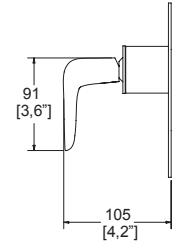
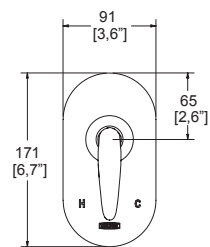

Presión mínima requerida 0.80 kg/cm².

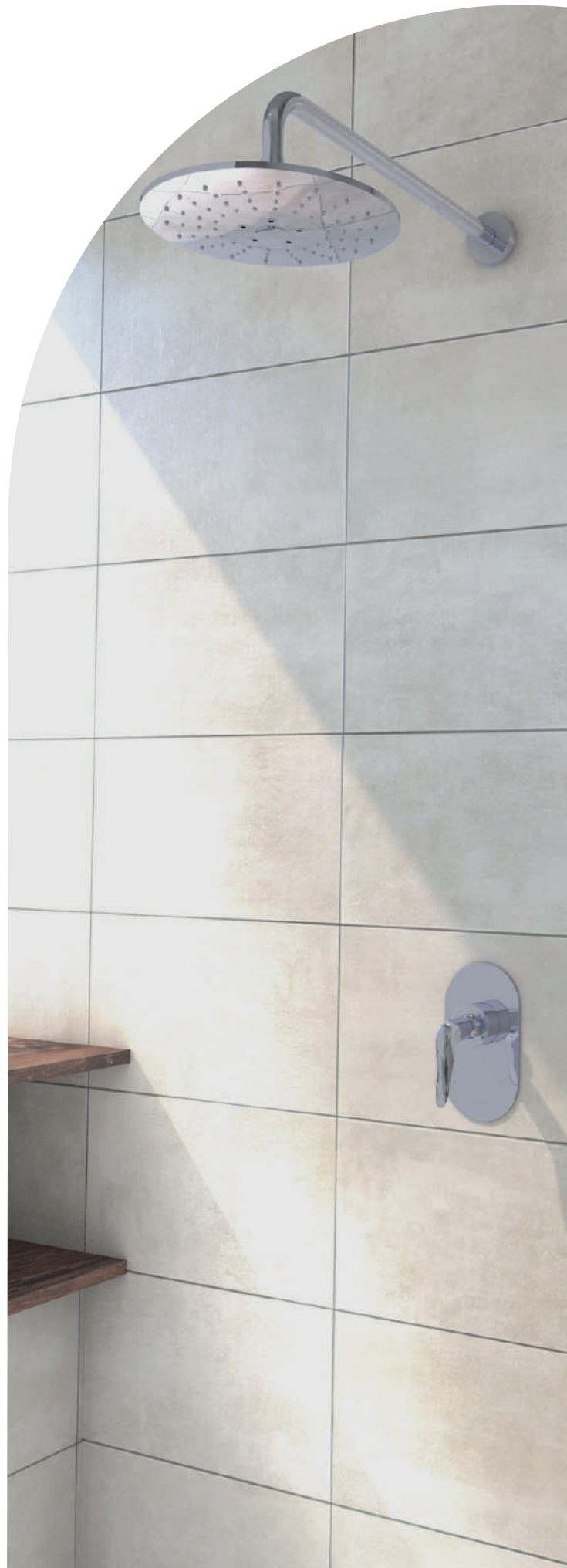

KÚBICA

E-48

Cromo

\$ 6,647.00

Monomando para regadera o tina sin desviador.

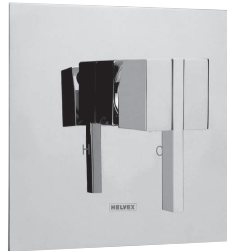

Dimensiones:
vista frontal

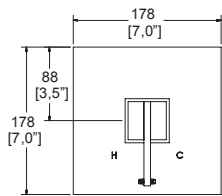

Dimensiones:
vista lateral

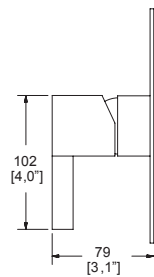

Presión mínima requerida 0.80 kg/cm².

VÉRTIKA

E-700

Cromo

\$ 5,694.00

Monomando para regadera o tina sin desviador.



Dimensiones:
vista frontal

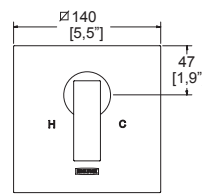

Dimensiones:
vista lateral

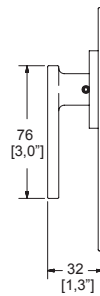

Presión mínima requerida 0.80 kg/cm².

VÉRTIKA

E-701

Cromo

\$ 6,267.00

Monomando para regadera, tina o regadera manual con desviador.



Dimensiones:
vista frontal

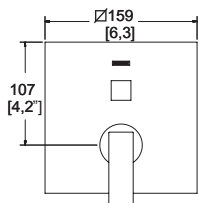

Dimensiones:
vista lateral

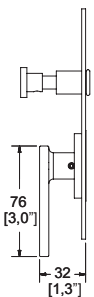

Presión mínima requerida 1.00 kg/cm².

LUSITANIA

LUS-200

Cromo

\$ 2,123.00

Monomando para regadera o tina sin desviador.



Dimensiones:
vista frontal

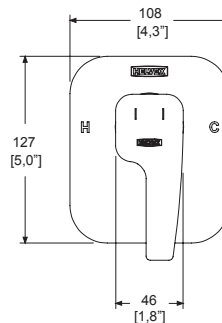

Dimensiones:
vista lateral

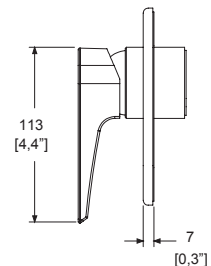

Maneral marcado con indicador de temperatura fría o caliente.

Presión mínima requerida 0.80 kg/cm².

MONOMANDOS PARA REGADERA O TINA

PIAZZA

PIA-200

Cromo

\$ 2,123.00

Monomando para regadera sin desviador.



Maneral marcado con indicador de temperatura fría o caliente.
Presión mínima requerida 0.80 kg/cm².



PIAZZA

PIA-200-EB

Ébano

\$ 2,441.00

Monomando para regadera sin desviador.



Presión mínima requerida 0.80 kg/cm².



Dimensiones:
vista frontal

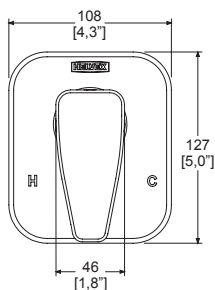

Dimensiones:
vista lateral

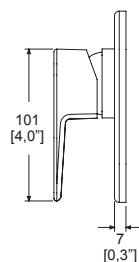



MONOMANDOS PARA REGADERA O TINA

SQUADRA

E-710

Cromo

\$ 4,208.00

Monomando para regadera o tina sin desviador.



Presión mínima requerida 0.80 kg/cm².

SQUADRA

E-710-EB

Ébano

\$ 4,839.00

Monomando para regadera o tina sin desviador.



Presión mínima requerida 0.80 kg/cm².

Dimensiones:
vista frontal

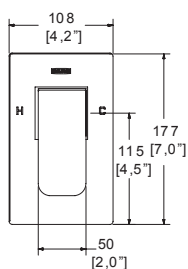

Dimensiones:
vista lateral

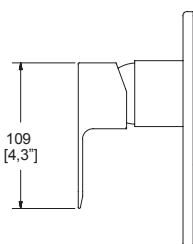

SQUADRA

E-711

Cromo

\$ 5,067.00

Monomando para regadera, tina o regadera manual con desviador.



Dimensiones:
vista frontal

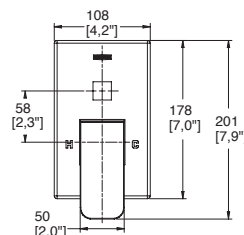

Dimensiones:
vista lateral

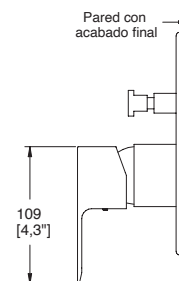

Presión mínima requerida 1.00 kg/cm².



MONOMANDO DE BALANCEO DE PRESIÓN PARA REGADERA O TINA

SQUADRA

E-793

Cromo

\$ 6,466.00

Monomando de balanceo de presión para regadera, tina o regadera manual con desviador.



Dimensiones:
vista frontal

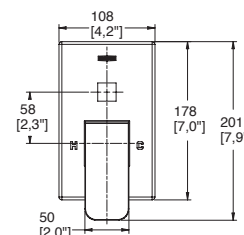

Dimensiones:
vista lateral

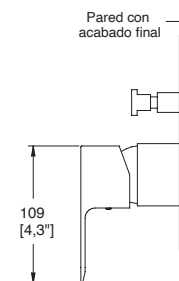

**Producto especial, solo sobre pedido.
30 días de entrega a partir del pedido.**

Presión mínima requerida 1.20 kg/cm².



MÁXIMA

E-712

Cromo

\$ 4,182.00

Monomando para regadera o tina, sin desviador.



CR

Presión mínima requerida 0.80 kg/cm².

MÁXIMA

E-712-EB

Ébano

\$ 4,809.00

Monomando para regadera o tina, sin desviador.



EB

Presión mínima requerida 0.80 kg/cm².

Dimensiones:
vista frontal

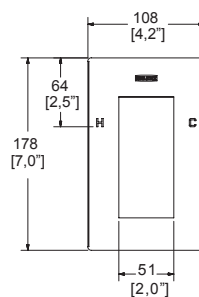

Dimensiones:
vista lateral

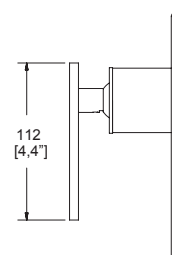

MONOMANDOS PARA REGADERA O TINA

MÁXIMA E-712-DN

Duna



\$ 4,809.00

Monomando para regadera o tina, sin desviador.



Presión mínima requerida 0.80 kg/cm².

DN

MÁXIMA E-712-TN

Titanium



\$ 4,809.00

Monomando para regadera o tina, sin desviador.



Presión mínima requerida 0.80 kg/cm².

TN

Dimensiones:
vista frontal

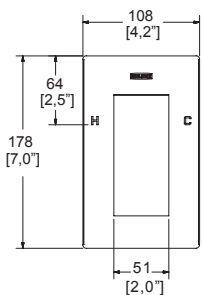

Dimensiones:
vista lateral

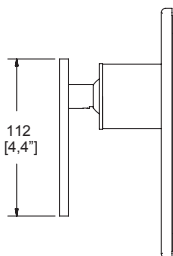

MÁXIMA

E-713

Cromo

\$ 5,067.00

Monomando para regadera, tina o regadera manual, con desviador.



Presión mínima requerida 1.00 kg/cm².

CR

MÁXIMA

E-713-EB

Ébano

\$ 5,827.00

Monomando para regadera, tina o regadera manual, con desviador.



Presión mínima requerida 1.00 kg/cm².

EB

Dimensiones:
vista frontal

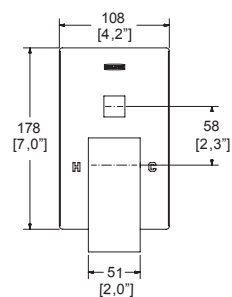

Dimensiones:
vista lateral

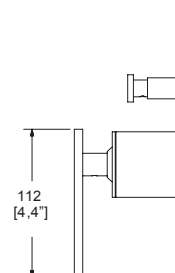

MONOMANDOS PARA REGADERA O TINA

MÁXIMA E-713-DN

Duna



\$ 5,827.00

Monomando para regadera, tina o regadera manual, con desviador.



Presión mínima requerida 1.00 kg/cm².

DN

MÁXIMA E-713-TN

Titanium



\$ 5,827.00

Monomando para regadera, tina o regadera manual, con desviador.



Presión mínima requerida 1.00 kg/cm².

TN

Dimensiones:
vista frontal

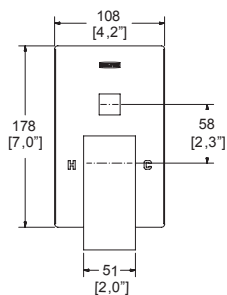

Dimensiones:
vista lateral

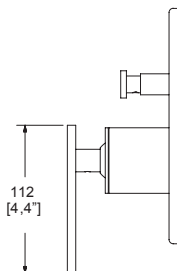

PIURA PIU-200

Cromo

\$ 7,040.00

Monomando para regadera o tina sin desviador.



Dimensiones:
vista frontal

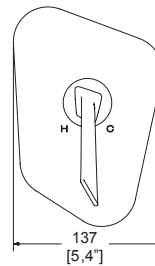

Dimensiones:
vista lateral

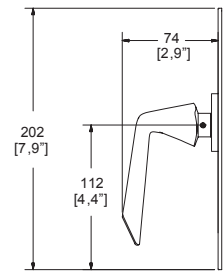

Presión mínima requerida 0.80 kg/cm².

CR

PIURA PIU-201

Cromo

\$ 8,014.00

Monomando para regadera, tina o regadera manual con desviador.



Dimensiones:
vista frontal

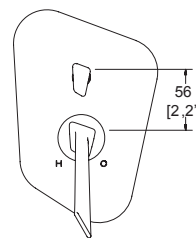

Dimensiones:
vista lateral

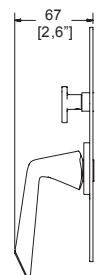

Presión mínima requerida 1.00 kg/cm².

CR

ACABADOS

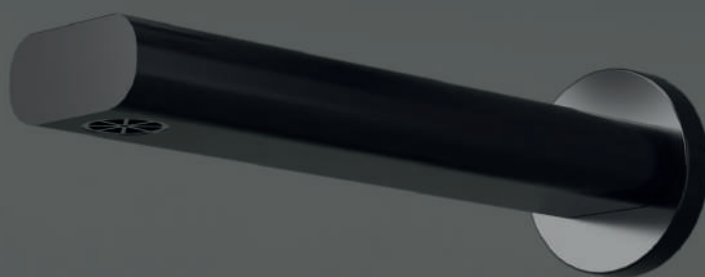

CR
Cromo



EB
Ébano

SALIDAS PARA TINA



Salidas de piso.



Salidas a pared.



Visite nuestra página web para consultar y descargar fichas técnicas e instructivos de instalación.
helvex.com     

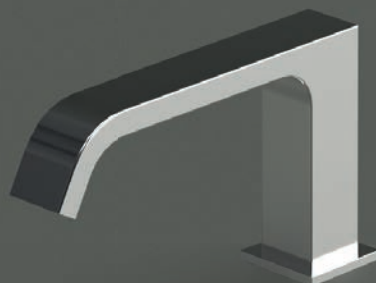
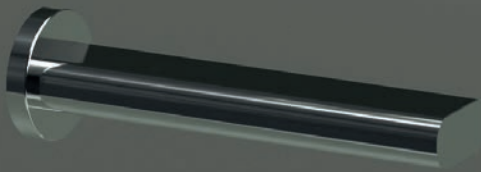
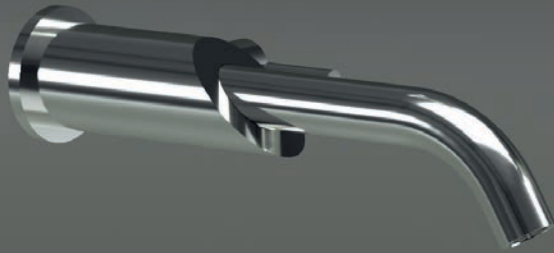
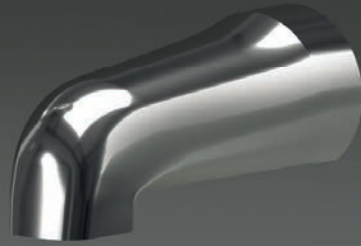

HELVEX[®]
Garantía de Calidad



Garantía Helvex en acabado cromo de 10 años y resto de acabados 2 años.

SALIDAS PARA TINA DE PARED

ELITE

TH-148

Cromo

\$ 2,471.00

Salida para tina a pared con desviador.



Dimensiones:
vista frontal

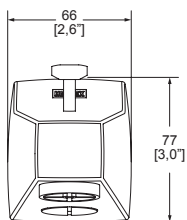

Dimensiones:
vista lateral

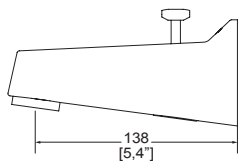

Presión mínima requerida 0.70 kg/cm².

CR

NUVA

TV-060

Cromo

\$ 3,537.00

Salida para tina a pared sin desviador.



Dimensiones:
vista frontal

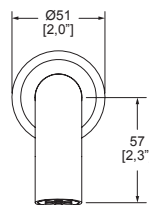

Dimensiones:
vista lateral

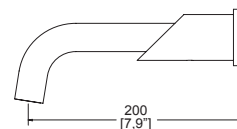

Presión mínima requerida 0.20 kg/cm².

CR

NUVA

TV-061

Cromo

\$ 3,829.00

Salida para tina a pared con desviador.



Dimensiones:
vista frontal

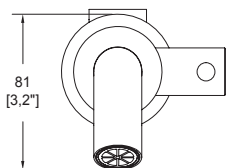

Dimensiones:
vista lateral

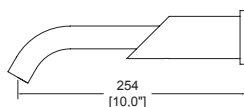

Presión mínima requerida 0.20 kg/cm².

CR

PREMIER

TV-062

Cromo

\$ 2,621.00

Salida para tina a pared sin desviador.



Dimensiones:
vista frontal

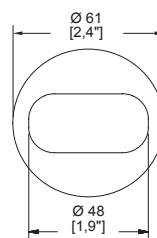

Dimensiones:
vista lateral

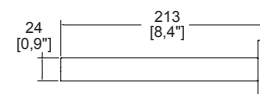

Presión mínima requerida 0.20 kg/cm².

CR

SALIDAS PARA TINA DE PARED

PREMIER

TV-062-EB

Ébano

\$ 3,015.00

Salida para tina a pared sin desviador.



Dimensiones:
vista frontal

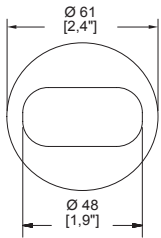

Dimensiones:
vista lateral

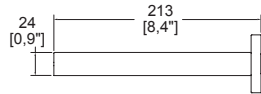

Presión mínima requerida 0.20 kg/cm².

EB

OLIMPO

TV-064

Cromo

\$ 2,187.00

Salida para tina a pared sin desviador.



Dimensiones:
vista frontal

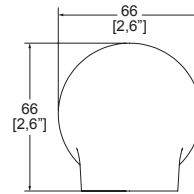

Dimensiones:
vista lateral

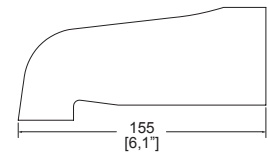

Presión mínima requerida 0.20 kg/cm².

CR

SALIDA PARA TINA DE PISO

VÉRTIKA

TV-069

Cromo

\$ 3,940.00

Salida para tina a pared con desviador.



Dimensiones:
vista frontal

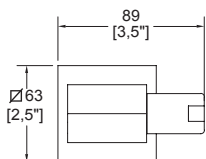

Dimensiones:
vista lateral

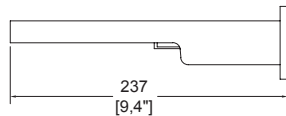

Presión mínima requerida 0.20 kg/cm².

CR

VÉRTIKA

TV-081

Cromo

\$ 7,016.00

Salida para tina a piso sin desviador.



Dimensiones:
vista frontal

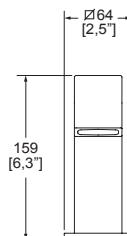

Dimensiones:
vista lateral

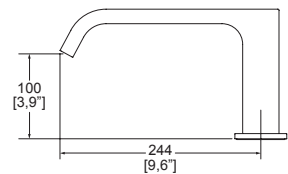

Presión mínima requerida 0.20 kg/cm².

CR

DESAGÜE PARA TINA

H-7190

Cromo

\$ 3,376.00

Desagüe para tina con sistema de push.



Dimensiones:
vista frontal

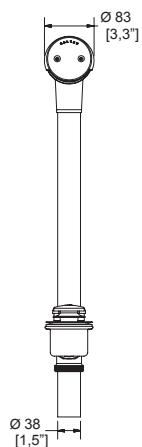

Dimensiones:
vista lateral

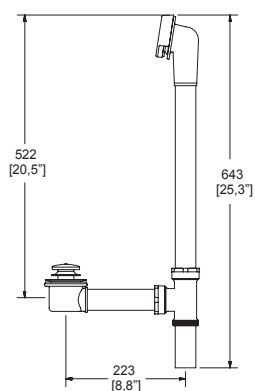

Acabado.



CR

COLADERAS



COLADERAS



Coladeras para piso en interiores.



- Cuerpo de hierro fundido.
- Plato de doble drenaje para evitar la humedad en el piso inferior de la construcción.
- Contras ajustables para colocarlas a diferentes alturas según el nivel del piso.
- Rejillas y casquillos removibles para mejor limpieza y mantenimiento.
- Césped integral que produce un sello hidráulico y evita malos olores.
- Recomendable para baños, regaderas, vestíbulos u otras áreas interiores.



Coladeras para piso en exteriores.



- Sello hidráulico de campana para evitar el paso de gases de las líneas de drenaje a la coladera.
- Recomendables para patios, terrazas, fábricas, plantas industriales, garages, cubos de elevador y lavanderías.



Coladeras para azotea.



- Rejillas removibles.
- Aditamento para colocación del impermeabilizante.
- Para colocarse en las bajadas pluviales situadas en el pretil de las azoteas.



Rebosaderos.



- Cuerpo de latón fundido y rejilla removible.
- Rejillas con gran capacidad de drenado (Redondos, cuadrados y rectangulares).
- Recomendable para pasillos y corredores.



Válvulas para drenaje.



- Tapa de registro removible.
- Conexiones de campana y espiga para que pueda instalarse en tubería de drenaje.
- Compuerta de latón que cierra a la menor presión en sentido contrario e impide el regreso de aguas negras.



Interceptores de Grasa.



- Construidos en placa cold rolled.
- Gran resistencia a la corrosión y oxidación por su capa de galvanizado.
- Tapa de registro corrugada antiderrapante para evitar accidentes.
- Para usarse en restaurantes o comedores industriales.
- Pueden ser expuestos o soterrados.

Visite nuestra página web para consultar y descargar fichas técnicas e instructivos de instalación.
helvex.com    



COLADERAS



Con rejillas redondas, cuadradas y rectangulares.

Coladeras decorativas, con desagües de contorno para incertos cerámicos.

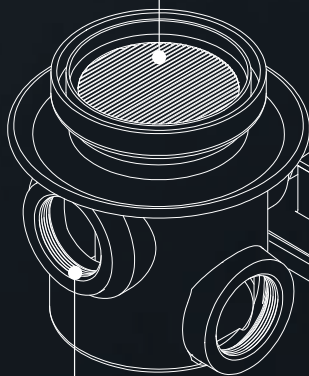

Coladeras de una, dos y tres bocas.



Sello hidráulico que evita el paso de malos olores.

COLADERAS ADAPTABLES
SEGÚN LAS NECESIDADES.

INTERIORES Y EXTERIORES PARA AZOTEAS,
PATIOS Y ZONAS DE GRAN AFLUENCIA

HELVEX

Garantía de Calidad

COLADERAS CORTAS

PARA ENTREPISOS MÁS DELGADOS

FABRICADAS
DE HIERRO FUNDIDO,
LATÓN Y ACERO
INOXIDABLE

Boca lateral

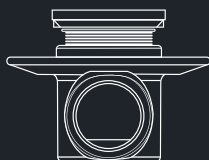

Boca vertical

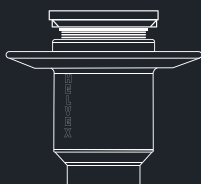

Césped de polietileno de alta densidad

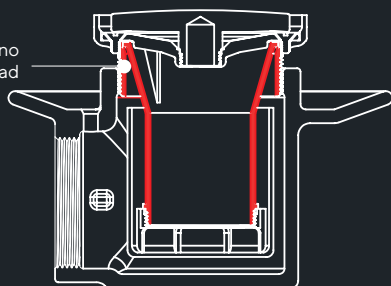

Entrepisos más delgados

Contra ajustable para colocar a diferentes alturas según el nivel del piso

Plato de drenado antifiltraciones

Sello hidráulico que impide el paso de malos olores

COLADERAS PARA PISO EN INTERIORES DE UNA BOCA

22

\$ 1,772.00

Coladera corta de una boca lateral, de rejilla redonda removible.



Dimensiones:
vista cenital

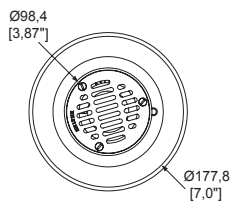

Dimensiones:
vista lateral

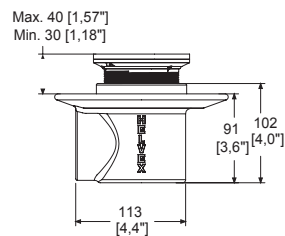

Ideal para las nuevas tendencias de la construcción, donde los **entrepisos son más delgados**.
Cuerpo de hierro fundido.

22-CH

\$ 1,939.00

Coladera corta de una boca lateral, de rejilla cuadrada removible.



Dimensiones:
vista cenital

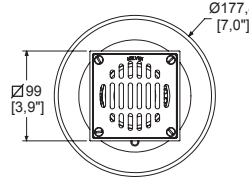

Dimensiones:
vista lateral

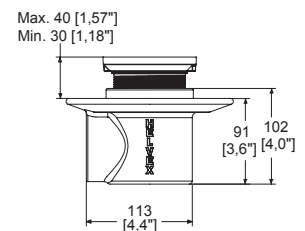

Ideal para las nuevas tendencias de la construcción, donde los **entrepisos son más delgados**.
Cuerpo de hierro fundido.

22-CHL

\$ 2,248.00

Coladera corta de una boca lateral, desagüe de contorno cuadrado, tapa removible.



Dimensiones:
vista cenital

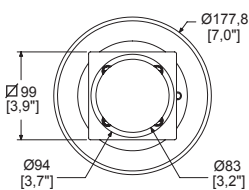

Dimensiones:
vista lateral

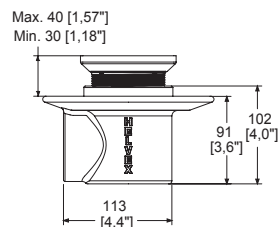

Ideal para las nuevas tendencias de la construcción, donde los **entrepisos son más delgados**.
Cuerpo de hierro fundido.

22-CHLI

\$ 2,248.00

Coladera corta de una boca lateral, desagüe de contorno cuadrado, portainsero removible.



Dimensiones:
vista cenital

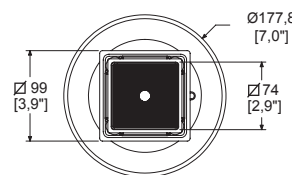

Dimensiones:
vista lateral

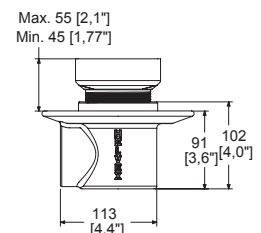

Ideal para las nuevas tendencias de la construcción, donde los **entrepisos son más delgados**.
Cuerpo de hierro fundido.

COLADERAS PARA PISO EN INTERIORES DE UNA BOCA

22-HL

\$ 2,087.00

Coladera corta de una boca lateral, desagüe de contorno redondo, tapa removible.



Dimensiones:
vista cenital

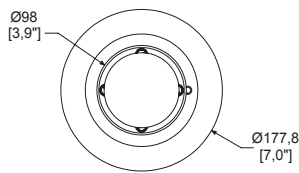

Dimensiones:
vista lateral

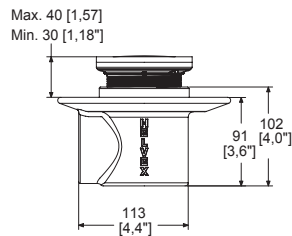

Ideal para las nuevas tendencias de la construcción, donde los **entrepisos son más delgados**. Cuerpo de hierro fundido.

22-HLI

\$ 2,087.00

Coladera corta de una boca lateral, desagüe de contorno redondo, portainsero removible.



Dimensiones:
vista cenital

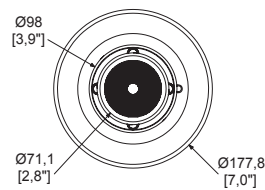

Dimensiones:
vista lateral

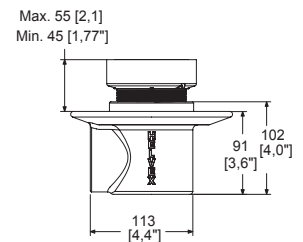

Ideal para las nuevas tendencias de la construcción, donde los **entrepisos son más delgados**. Cuerpo de hierro fundido.

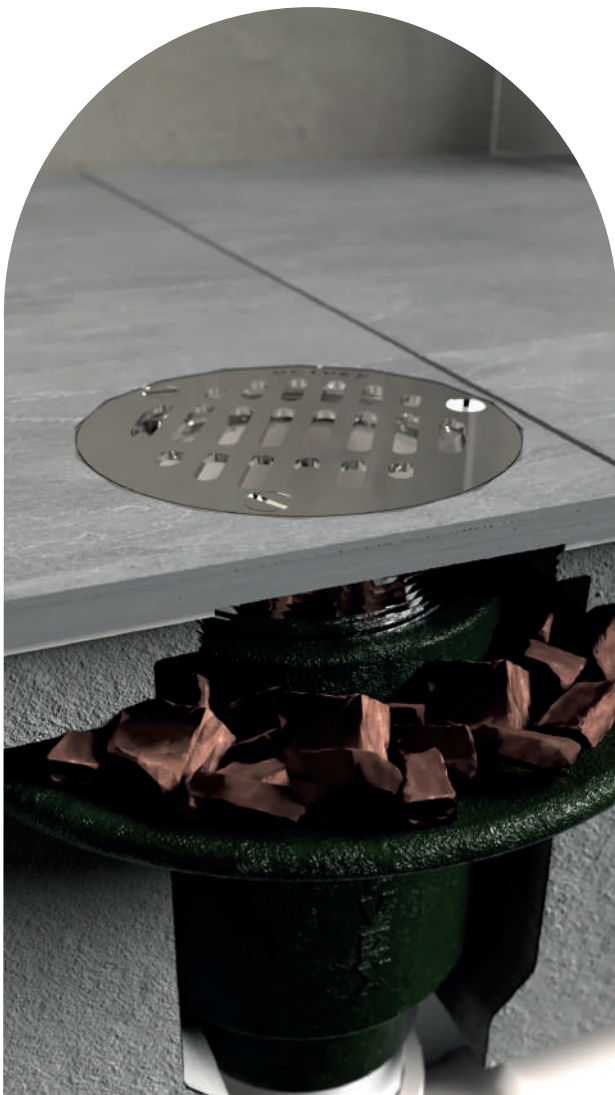

22V

\$ 1,772.00

Coladera corta de una boca vertical, de rejilla redonda removible.



Dimensiones:
vista cenital

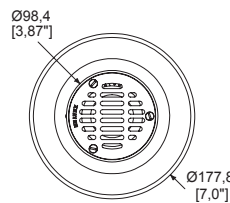

Dimensiones:
vista lateral

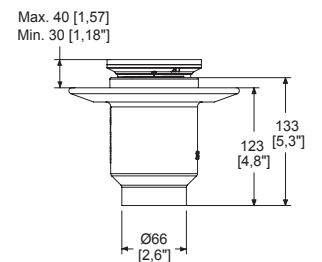

Por la ubicación de su conexión reduce tiempos y costos de instalación, conexiones adicionales y se adapta a cualquier espesor de losa. **Para entrecios más delgados**. Cuerpo de hierro fundido.

COLADERAS PARA PISO EN INTERIORES DE UNA BOCA

22V-CH

\$ 1,939.00

Coladera corta de una boca vertical, de rejilla cuadrada removible.



Dimensiones:
vista cenital

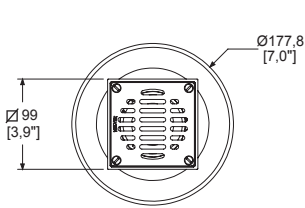

Dimensiones:
vista lateral

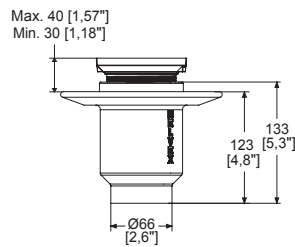

Por la ubicación de su conexión reduce tiempos y costos de instalación, conexiones adicionales y se adapta a cualquier espesor de losa. **Para entrepisos más delgados.**
Cuerpo de hierro fundido.

22V-CHL

\$ 2,248.00

Coladera corta de una boca vertical, desagüe de contorno cuadrado, tapa removible.



Dimensiones:
vista cenital

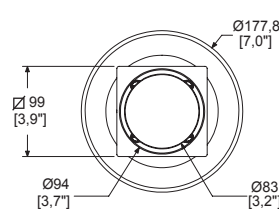

Dimensiones:
vista cenital

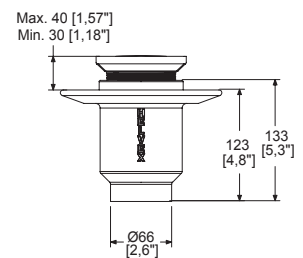

Por la ubicación de su conexión reduce tiempos y costos de instalación, conexiones adicionales y se adapta a cualquier espesor de losa. **Para entrepisos más delgados.**
Cuerpo de hierro fundido.

22V-CHLI

\$ 2,248.00

Coladera corta de una boca vertical, desagüe de contorno cuadrado, portainsero removible



Dimensiones:
vista cenital

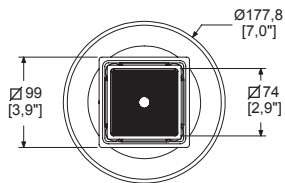

Dimensiones:
vista lateral

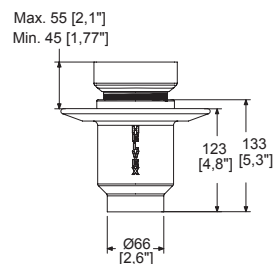

Por la ubicación de su conexión reduce tiempos y costos de instalación, conexiones adicionales y se adapta a cualquier espesor de losa. **Para entrepisos más delgados.**
Cuerpo de hierro fundido.



COLADERAS PARA PISO EN INTERIORES DE UNA BOCA

22V-HL

\$ 2,087.00

Coladera corta de una boca vertical, desagüe de contorno redondo, tapa removible.



Dimensiones:
vista cenital

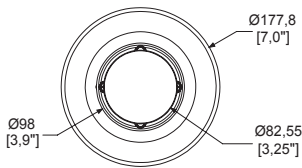

Dimensiones:
vista lateral

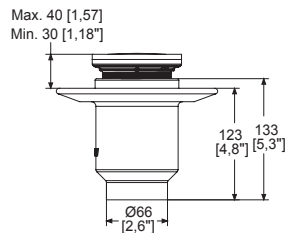

Por la ubicación de su conexión reduce tiempos y costos de instalación, conexiones adicionales y se adapta a cualquier espesor de losa. **Para entrepisos más delgados.** Cuerpo de hierro fundido.

22V-HLI

\$ 2,087.00

Coladera corta de una boca vertical, desagüe de contorno redondo, portainsero removible.



Dimensiones:
vista cenital

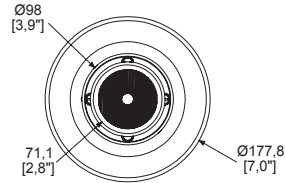

Dimensiones:
vista lateral

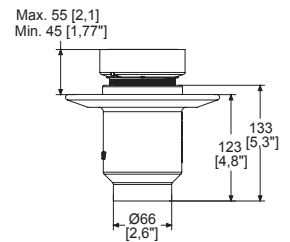

Por la ubicación de su conexión reduce tiempos y costos de instalación, conexiones adicionales y se adapta a cualquier espesor de losa. **Para entrepisos más delgados.** Cuerpo de hierro fundido.



24

\$ 1,772.00

Coladera de una boca, de rejilla redonda.



Dimensiones:
vista cenital

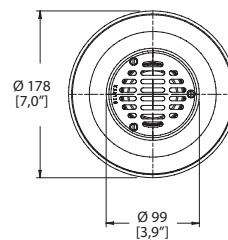

Dimensiones:
vista lateral

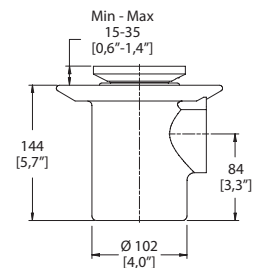

Sello hidráulico.
No permite el paso de malos olores.
Cuerpo de hierro fundido.

24-CH

\$ 1,939.00

Coladera de una boca, de rejilla cuadrada.



Dimensiones: vista cenital

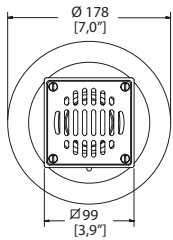

Dimensiones: vista lateral

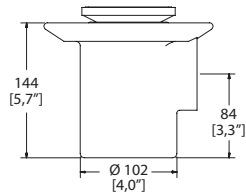

Sello hidráulico.
No permite el paso de malos olores.
Cuerpo de hierro fundido.

24-CHL

\$ 2,248.00

Coladera de una boca, tapa redonda desagüe de contorno cuadrado.



Dimensiones: vista cenital

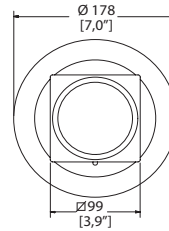

Dimensiones: vista lateral

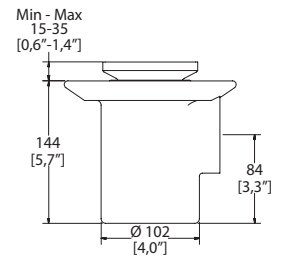

Sello hidráulico.
No permite el paso de malos olores.
Cuerpo de hierro fundido.

24-CHLI

\$ 2,248.00

Coladera de una boca, desagüe de contorno cuadrado para inserto cerámico máximo de 10 mm.



Dimensiones: vista cenital

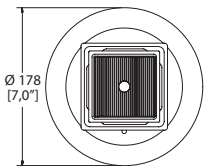

Dimensiones: vista lateral

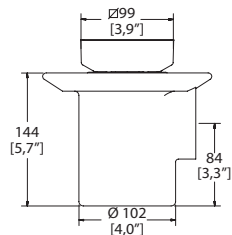

Sello hidráulico.
No permite el paso de malos olores.
Cuerpo de hierro fundido.



COLADERAS PARA PISO EN INTERIORES DE UNA BOCA

24-HL

\$ 2,087.00

Coladera de una boca, desagüe de contorno tapa redonda.



Dimensiones:
vista cenital

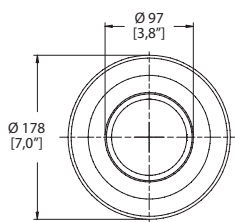

Dimensiones:
vista lateral

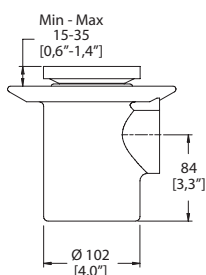

Sello hidráulico.
No permite el paso de malos olores.
Cuerpo de hierro fundido.

24-HLI

\$ 2,087.00

Coladera de una boca, desagüe de contorno redondo para inserto cerámico máximo de 10 mm.



Dimensiones:
vista cenital

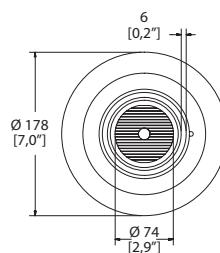

Dimensiones:
vista lateral

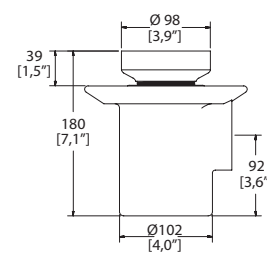

Sello hidráulico.
No permite el paso de malos olores.
Cuerpo de hierro fundido.

24-RHLI

\$ 5,139.00

Coladera rectangular de una boca, desagüe de contorno rectangular para inserto cerámico máximo de 10 mm.



Dimensiones:
vista cenital

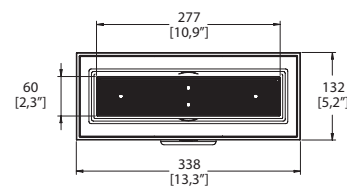

Dimensiones:
vista lateral

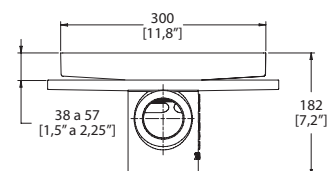

Sello hidráulico.
No permite el paso de malos olores.
Cuerpo de hierro fundido.



24-RHLI-60

\$ 7,829.00

Coladera decorativa alargada de **60 cm**, perfil de latón con charola de acero inoxidable y base de hierro gris.



Dimensiones:
vista cenital

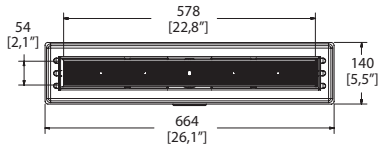

Dimensiones:
vista lateral

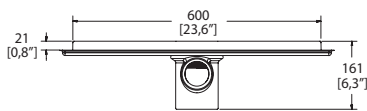

Sello hidráulico.
No permite el paso de malos olores.
Cuerpo de hierro fundido.

24-RHLI-90

\$ 10,277.00

Coladera decorativa alargada de **90 cm**, perfil de latón con charola de acero inoxidable y base de hierro gris.



Dimensiones:
vista cenital

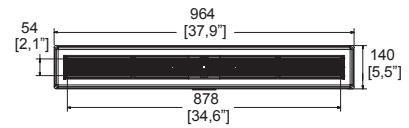

Dimensiones:
vista lateral

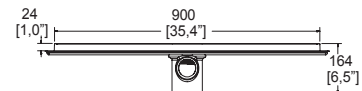

Sello hidráulico.
No permite el paso de malos olores.
Cuerpo de hierro fundido.

27

\$ 2,314.00

Coladera alta de una boca, rejilla redonda de 25 cm.



Dimensiones:
vista cenital

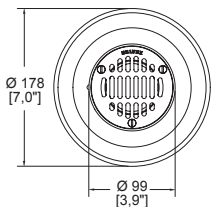

Dimensiones:
vista lateral

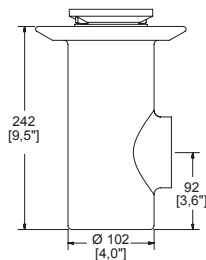

Sello hidráulico.
No permite el paso de malos olores.
Cuerpo de hierro fundido.



COLADERAS PARA PISO EN INTERIORES DE UNA BOCA

282-35-CHL

\$ 5,139.00

Coladera de una boca, desagüe de contorno cuadrado.



Dimensiones:
vista cenital

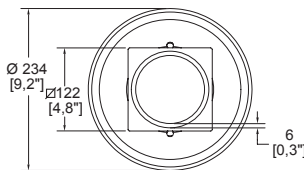

Dimensiones:
vista lateral

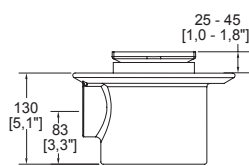

Sello hidráulico.
No permite el paso de malos olores.
Cuerpo de hierro fundido.

282-35-CHLI

\$ 5,139.00

Coladera de una boca, desagüe de contorno cuadrado para inserto cerámico máximo de 10 mm.



Dimensiones:
vista cenital

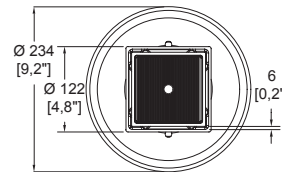

Dimensiones:
vista lateral

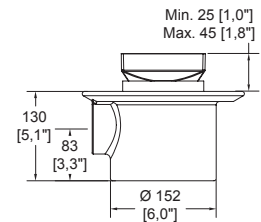

Sello hidráulico.
No permite el paso de malos olores.
Cuerpo de hierro fundido.

282-35CH

\$ 4,515.00

Coladera de una boca, rejilla cuadrada.



Dimensiones:
vista cenital

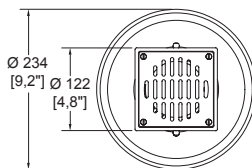

Dimensiones:
vista lateral

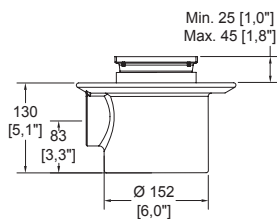

Sello hidráulico.
No permite el paso de malos olores.
Cuerpo de hierro fundido.

282-H

\$ 3,315.00

Coladera de una boca, rejilla redonda.



Dimensiones:
vista cenital

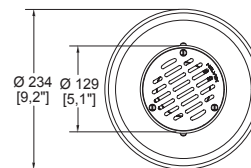

Dimensiones:
vista lateral

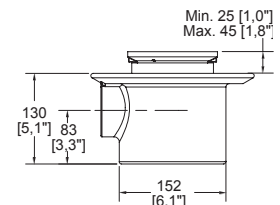

Sello hidráulico.
No permite el paso de malos olores.
Cuerpo de hierro fundido.

COLADERAS PARA PISO EN INTERIORES DE UNA Y TRES BOCAS

282-HL

\$ 3,908.00

Coladera redonda de una boca, desagüe de contorno de contorno.



Dimensiones: vista cenital

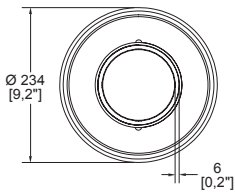

Dimensiones: vista lateral

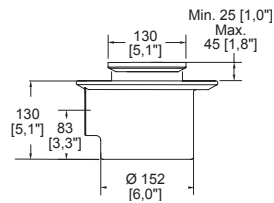

Sello hidráulico.
No permite el paso de malos olores.
Cuerpo de hierro fundido.

282-HLI

\$ 3,908.00

Coladera de una boca, desagüe de contorno redondo para inserto cerámico máximo de 10 mm.



Dimensiones: vista cenital

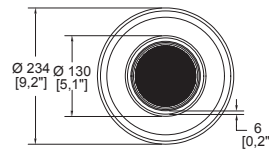

Dimensiones: vista lateral

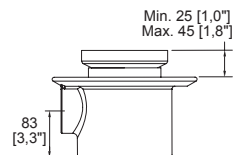

Sello hidráulico.
No permite el paso de malos olores.
Cuerpo de hierro fundido.

25

\$ 1,972.00

Coladera de tres bocas, rejilla redonda.



Dimensiones: vista cenital

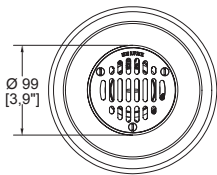

Dimensiones: vista lateral

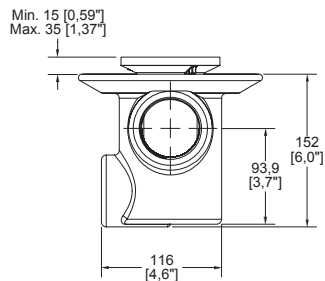

Sello hidráulico.
No permite el paso de malos olores.
Cuerpo de hierro fundido.

25-CH

\$ 2,128.00

Coladera de tres bocas, rejilla cuadrada.



Dimensiones: vista cenital

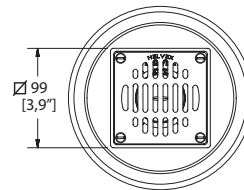

Dimensiones: vista lateral

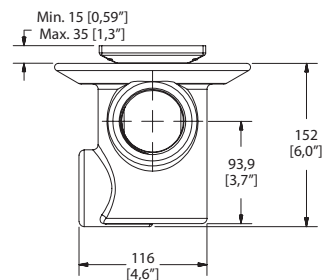

Sello hidráulico.
No permite el paso de malos olores.
Cuerpo de hierro fundido.

COLADERAS PARA PISO EN INTERIORES DE TRES BOCAS

25-CHL

\$ 2,442.00

Coladera de tres bocas, desagüe de contorno cuadrado.



Dimensiones:
vista cenital

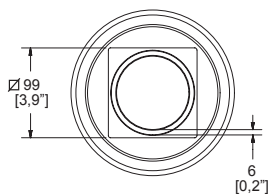

Dimensiones:
vista lateral

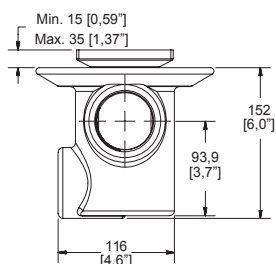

Sello hidráulico.
No permite el paso de malos olores.
Cuerpo de hierro fundido.

25-CHLI

\$ 2,442.00

Coladera cuadrada de tres bocas, desagüe de contorno para inserto cerámico máximo de 10 mm.



Dimensiones:
vista cenital

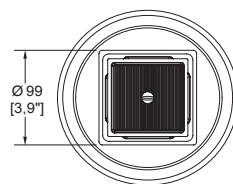

Dimensiones:
vista lateral

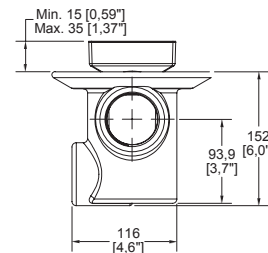

Sello hidráulico.
No permite el paso de malos olores.
Cuerpo de hierro fundido.

25-HL

\$ 2,282.00

Coladera de tres bocas, desagüe de contorno rejilla redonda.



Dimensiones:
vista cenital

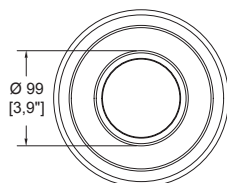

Dimensiones:
vista lateral

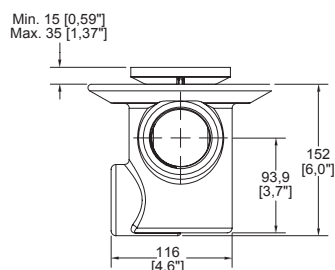

Sello hidráulico.
No permite el paso de malos olores.
Cuerpo de hierro fundido.

25-HLI

\$ 2,282.00

Coladera de tres bocas, desagüe de contorno redondo para inserto cerámico máximo de 10 mm.



Dimensiones:
vista cenital

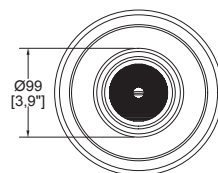

Dimensiones:
vista lateral

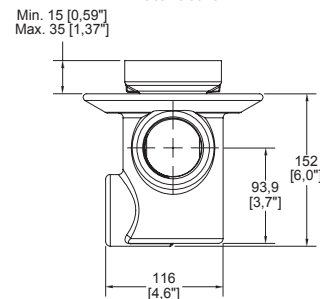

Sello hidráulico.
No permite el paso de malos olores.
Cuerpo de hierro fundido.

COLADERAS PARA PISO EN INTERIORES DE TRES BOCAS

26

\$ 2,032.00

Coladera de tres bocas, con tapa ciega redonda.



Dimensiones:
vista cenital

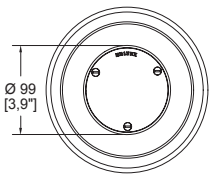

Dimensiones:
vista lateral

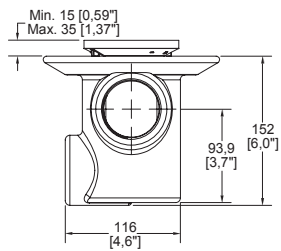

Sello hidráulico.
No permite el paso de malos olores.
Cuerpo de hierro fundido.

28

\$ 2,472.00

Coladera alta de tres bocas, rejilla redonda de 25 cm.



Dimensiones:
vista cenital

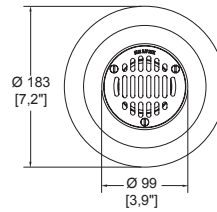

Dimensiones:
vista lateral

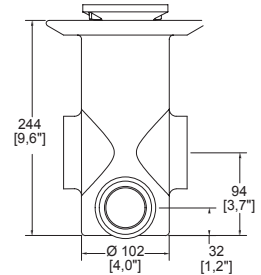

Sello hidráulico.
No permite el paso de malos olores.
Cuerpo de hierro fundido.

1342-35-CHL

\$ 4,408.00

Coladera de tres bocas, desagüe de contorno cuadrado.



Dimensiones:
vista cenital

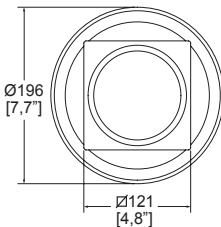

Dimensiones:
vista lateral

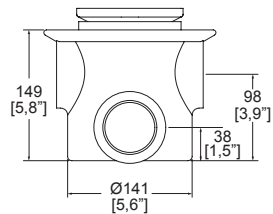

Sello hidráulico.
No permite el paso de malos olores.
Cuerpo de hierro fundido.

1342-35-CHLI

\$ 4,408.00

Coladera de tres bocas, desagüe de contorno cuadrado para inserto cerámico máximo de 10 mm.



Dimensiones:
vista cenital

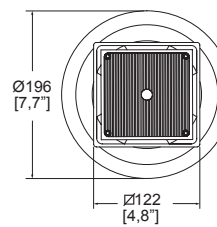

Dimensiones:
vista lateral

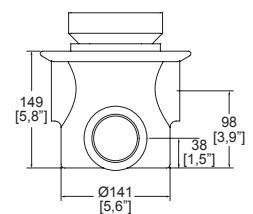

Sello hidráulico.
No permite el paso de malos olores.
Cuerpo de hierro fundido.

COLADERAS PARA PISO EN INTERIORES DE TRES BOCAS

1342-35CH

\$ 3,800.00

Coladera de tres bocas, rejilla cuadrada.



Dimensiones:
vista cenital

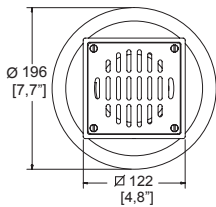

Dimensiones:
vista lateral

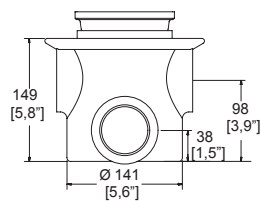

Sello hidráulico.
No permite el paso de malos olores.
Cuerpo de hierro fundido.

1342-H

\$ 2,822.00

Coladera de tres bocas, rejilla redonda.



Dimensiones:
vista cenital

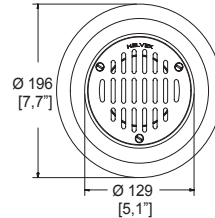

Dimensiones:
vista lateral

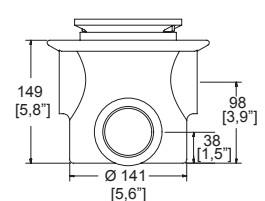

Sello hidráulico.
No permite el paso de malos olores.
Cuerpo de hierro fundido.

1342-HL

\$ 3,409.00

Coladera de tres bocas, desagüe de contorno redondo.



Dimensiones:
vista cenital

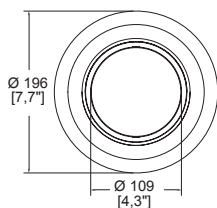

Dimensiones:
vista lateral

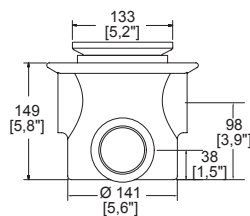

Sello hidráulico.
No permite el paso de malos olores.
Cuerpo de hierro fundido.

1342-HLI

\$ 3,409.00

Coladera de tres bocas, desagüe de contorno redondo para inserto cerámico máximo de 10 mm.



Dimensiones:
vista cenital

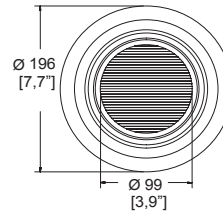

Dimensiones:
vista lateral

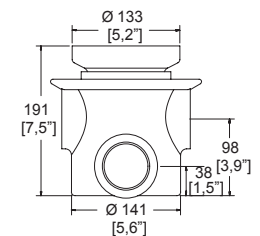

Sello hidráulico.
No permite el paso de malos olores.
Cuerpo de hierro fundido.

2514

\$ 2,902.00

Coladera de rejilla redonda con campana. Conexión para tubo de 102 mm (4") de roscar. Con gran capacidad de drenado. Tránsito pesado. Sello hidráulico.



Dimensiones:
vista cenital

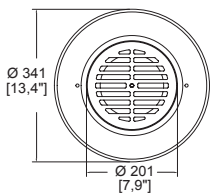

Dimensiones:
vista lateral

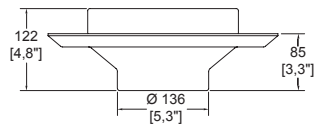

Para patios, garages, terrazas, etc.
Cuerpo de hierro fundido.

2584

\$ 8,436.00

Coladera de rejilla cuadrada, de acero inoxidable con campana. Conexión para tubo de 102 mm (4") de roscar. Sello hidráulico.



Dimensiones:
vista cenital

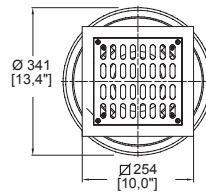

Dimensiones:
vista lateral

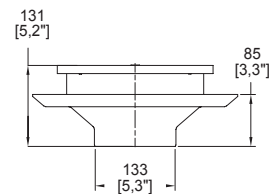

Exteriores y/o interiores.
Cuerpo de hierro fundido.

2714

\$ 6,959.00

Coladera de rejilla rectangular con campana. Conexión para tubo de 102 mm (4") de roscar. Con gran capacidad de drenado. Sello hidráulico.



Dimensiones:
vista cenital

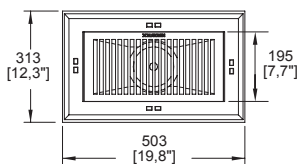

Dimensiones:
vista lateral

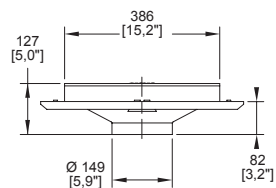

Para patios, garages, terrazas, etc.
Cuerpo de hierro fundido.

5424

\$ 3,195.00

Coladera de rejilla redonda, con canastilla para sedimentos. Conexión para tubo de 102 mm (4") de roscar. Para terrazas, plantas industriales, fábricas, tránsito pesado.



Dimensiones:
vista cenital

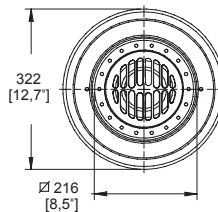

Dimensiones:
vista lateral

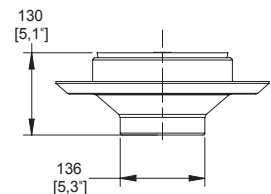

Usos: Para jardines o terrazas con plantas.
Cuerpo de hierro fundido.

COLADERAS PARA AZOTEA

4954

\$ 2,850.00

Coladera de pretil para azotea.
Conexión para tubo 102 mm (4") de roscar.



Dimensiones:
vista frontal

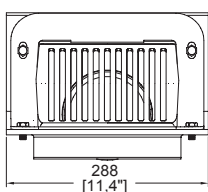

Dimensiones:
vista lateral

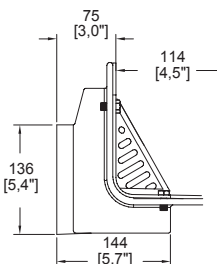

Cuerpo de hierro fundido.

444

\$ 1,888.00

Coladera de cúpula para azotea.
Conexión para tubo 102 mm (4") de roscar.



Dimensiones:
vista cenital

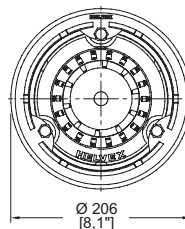

Dimensiones:
vista lateral

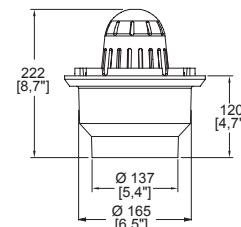

Cuerpo de hierro fundido.

444-X

\$ 1,888.00

Coladera de cúpula para azotea.
Conexión para tubo 102 mm (4") de retacar.



Dimensiones:
vista cenital

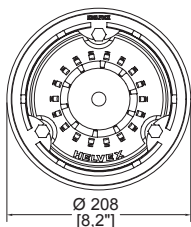

Dimensiones:
vista lateral

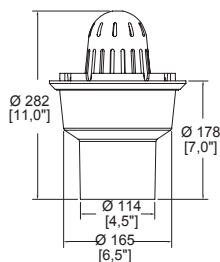

Cuerpo de hierro fundido.

446-X

\$ 3,837.00

Coladera de cúpula para azotea.
Conexión para tubo 153 mm (6") de retacar.



Dimensiones:
vista cenital

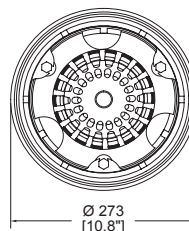

Dimensiones:
vista lateral

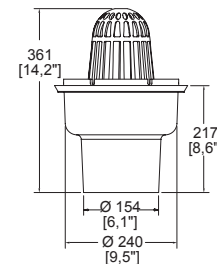

Cuerpo de hierro fundido.

342-C

Acero inoxidable

\$ 1,168.00

Rebosadero de rejilla cuadrada. Conexión para tubo 51 mm (2") de retacar.



Dimensiones:
vista cenital

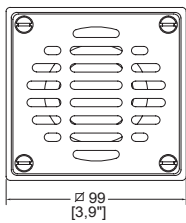

Dimensiones:
vista lateral

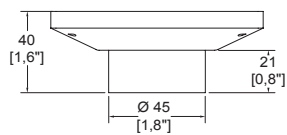

Cuerpo de latón forjado y rejilla de acero inoxidable.



AI

342-CL

\$ 1,340.00

Rebosadero con desagüe de contorno cuadrado. Conexión para tubo 51 mm (2") de retacar.



Dimensiones:
vista cenital

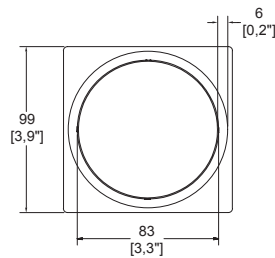

Dimensiones:
vista lateral

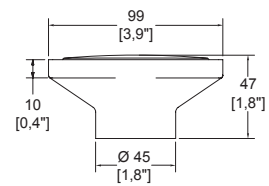

Contra de latón forjado y cúpula de latón.

342-R

Acero inoxidable

\$ 997.00

Rebosadero de rejilla redonda. Conexión para tubo 51 mm (2") de retacar.



Dimensiones:
vista cenital

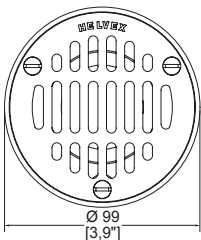

Dimensiones:
vista lateral

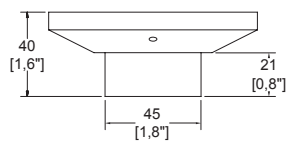

Cuerpo de latón forjado y rejilla de acero inoxidable.



AI



REBOSADEROS

342-RL

\$ 1,139.00

Rebosadero con desagüe de contorno redondo. Conexión para tubo 51 mm (2") de retacar.



Dimensiones:
vista cenital

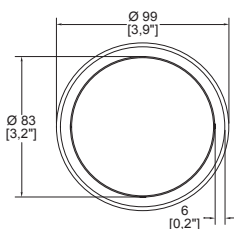

Dimensiones:
vista lateral

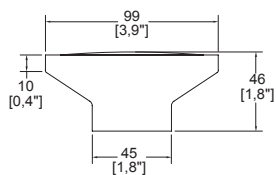

Contra de latón forjado y cúpula de latón.

632-H

Acero inoxidable

\$ 2,625.00

Rebosadero de rejilla rectangular de acero inoxidable. Conexión para tubo 51 mm (2") de roscar.



Dimensiones:
vista cenital

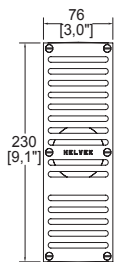

Dimensiones:
vista lateral

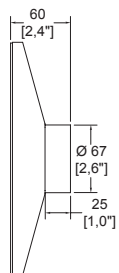

Usos: Para pasillos o alberca.
Cuerpo de latón y rejilla de acero inoxidable.



AI



IG-20

\$ 20,701.00

Interceptor de grasa con canastilla para sedimentos sólidos de 45 L/min y 18 kg de capacidad. Conexión para tubo de 2" de roscar.



Dimensiones:
vista cenital

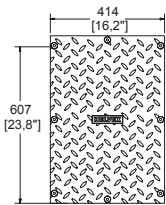

Dimensiones:
vista lateral

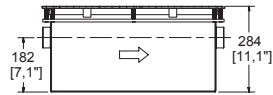

Puede colocarse de manera expuesta o soterrada.

IG-40

\$ 35,863.00

Interceptor de grasa con canastilla para sedimentos sólidos de 90 L/min y 36 kg de capacidad. Conexión para tubo de 4" de roscar.



Dimensiones:
vista cenital

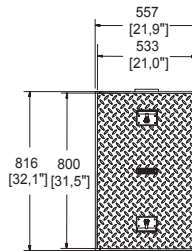

Dimensiones:
vista lateral

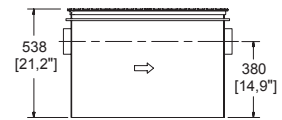

Puede colocarse de manera expuesta o soterrada.

IG-20-PTM

\$ 16,325.00

Interceptor de grasa de polietileno con tapa metálica y canastilla para sedimentos sólidos de 45 L/min y 18 kg de capacidad. Conexión para tubo de 2" de roscar.



Dimensiones:
vista cenital

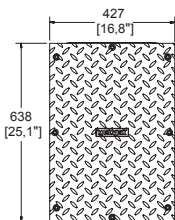

Dimensiones:
vista lateral

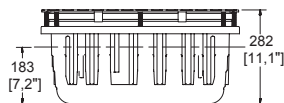

VÁLVULAS PARA DRENAJE

V.D.1176

\$ 9,143.00

Válvula de drenaje antirretorno.
Para tubo de albañal.
Compuerta de latón.



Dimensiones:
vista cenital

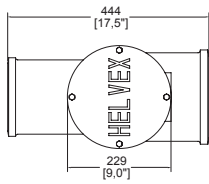

Dimensiones:
vista lateral

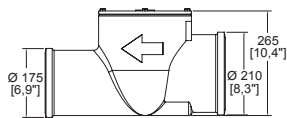

Se instala con una inclinación de 1 cm por metro lineal.

V.D.1176-6

\$ 9,143.00

Válvula de drenaje antirretorno.
Para tubo de PVC sanitario de 6".
Compuerta de latón.



Dimensiones:
vista cenital

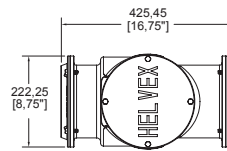

Dimensiones:
vista lateral

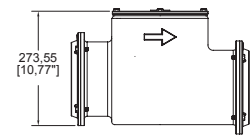

Se instala con una inclinación de 1 cm por metro lineal.

ACABADOS



CR
Cromo

LLAVES PARA HOSPITAL



Mezcladoras con cuello de ganso.



Llaves electrónicas a pared.*



Llaves unitarias con cuello de ganso.

Hospitales importantes en donde se han especificado nuestros productos:

- Hospital Ángeles Acoxta
- Hospital Ángeles Interlomas
- Hospital Dalinde San Ángel
- Hospital Ángeles Pedregal
- Hospital Dalinde Tuxpan
- Hospital ISSEMYM Toluca
- Hospital ISSEMYM Tlalnepantla
- Hospital ISSEMYM Zumpango
- Hospital Médica Sur
- Clínica ISSSTE Zona 1 Marina Nacional
- Clínica ISSSTE Zona 1 San Antonio Abad

* NOM-001-SCFI-2018

"Aparatos electrónicos – Requisitos de seguridad y Métodos de Prueba".

Visite nuestra página web para consultar y descargar fichas técnicas e instructivos de instalación.
helvex.com     



LLAVES PARA HOSPITAL



MODELOS AHORRADORES DISPONIBLES



ECOLVEX

Productos con uso
eficiente de agua.

NMX

NMX-C-415-ONNCCF-2015 "Industria de la
Construcción - Válvulas y Grifos para
Agua - Especificaciones y Métodos de ensayo".

*Sólo aplica con productos Ecolvex:
H13341G-1.9 y VCG2-1.9

Llaves con sensor electrónico
de baterías o corriente a pared.



Llaves con cuello
de ganso giratorio.



Mezcladora de manijas largas.

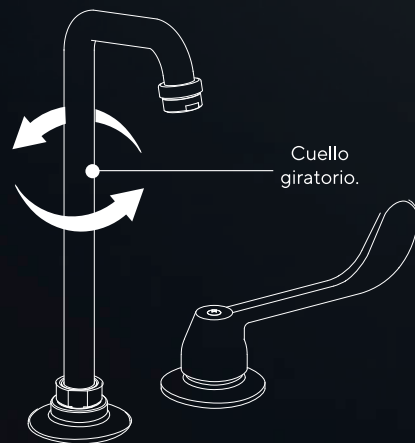

Cuello
giratorio.

HELVEX

Garantía de Calidad



Garantía Helvex en acabado cromo de 10 años
y resto de acabados 2 años.

LLAVES DE LAVABO ELECTRÓNICAS DE SENSOR A PARED

TV-201

Cromo

 **De baterías**
alcalinas AA

\$ 15,545.00

 **Modelo ahorrador**
TV201-1.9



TV-201-C

Cromo

 **De corriente**

\$ 16,379.00

 **Modelo ahorrador**
TV201-C-1.9



Cuello giratorio.
Presión mínima requerida 0.40 kg/cm².

CR

Dimensiones:
vista frontal

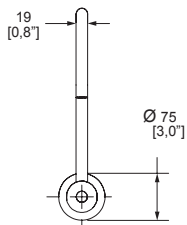

Dimensiones:
vista lateral

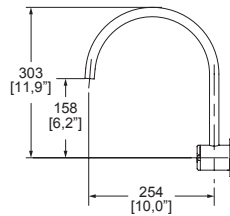

NOM NOM-001-SCFI-2018



TV-203

Cromo

 **De baterías**
alcalinas AA

\$ 15,545.00

 **Modelo ahorrador**
TV203-1.9

TV-203-C

Cromo

 **De corriente**

\$ 16,379.00

 **Modelo ahorrador**
TV203-C-1.9

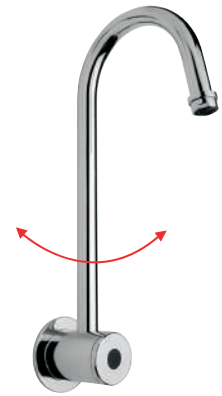

Cuello giratorio.
Presión mínima requerida 0.40 kg/cm².

CR

Dimensiones:
vista frontal

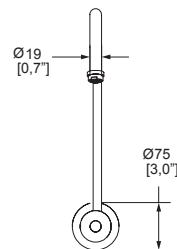

Dimensiones:
vista lateral

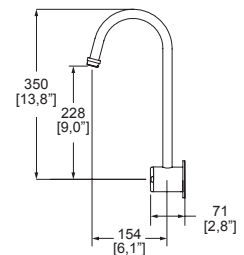

NOM NOM-001-SCFI-2018

LLAVES DE HOSPITAL

VCG-2

Cromo

\$ 4,040.00

Llave de hospital con cuello de ganso giratorio manija corta.



Modelo ahorrador VCG2-1.9

Dimensiones: vista frontal

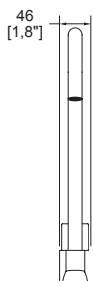

Dimensiones: vista lateral

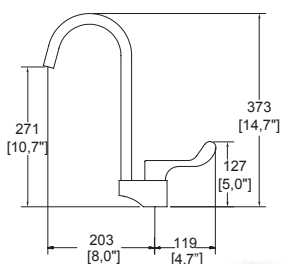

Cuello giratorio.

Presión mínima requerida 0.25 kg/cm².

NMX NMX-C-415-ONNCCE-2015

CR

VCG-2T

Cromo

\$ 4,040.00

Llave de hospital con cuello de ganso giratorio. Maneral **Tritón**.

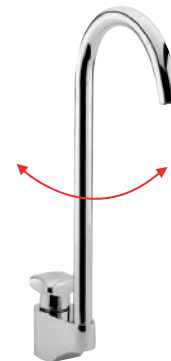

Dimensiones: vista frontal

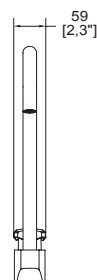

Dimensiones: vista lateral

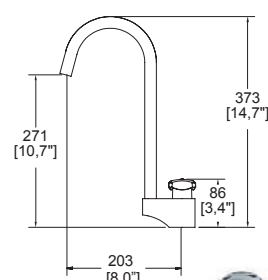

Cuello giratorio.

Presión mínima requerida 0.25 kg/cm².

CR



H-13341G

Cromo

\$ 7,225.00

Mezcladora de hospital 8" a 12" con cuello de ganso giratorio y manijas largas. No incluye contra.



Modelo ahorrador H13341G-1.9

Dimensiones: vista frontal

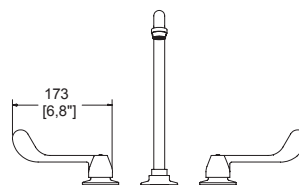

Dimensiones: vista lateral

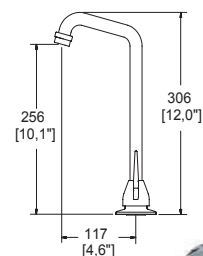

Incluye manerales.

Cuello giratorio.

Presión mínima requerida 0.25 kg/cm².

NMX NMX-C-415-ONNCCE-2015

CR

ACABADOS



CR
Cromo

LLAVES ECONOMIZADORAS



Llaves economizadoras de válvula.



Llaves temporizadoras con botón de push.



A piso y a pared.

Todas nuestras llaves economizadoras son productos ahorradores con los que Helvex favorece la edificación sustentable, optimizando y midiendo las acciones para salvaguardar los recursos naturales con un consumo máximo desde 1.9 hasta 5 litros por minuto.

Tecnología innovadora

- Llaves economizadoras que por su mecanismo evitan el desperdicio de agua.
- Las llaves temporizadoras, cuentan con un mecanismo de tiempo de activación programado, que evita el desperdicio de agua.

Visite nuestra página web para consultar y descargar fichas técnicas e instructivos de instalación.
helvex.com     



LLAVES ECONOMIZADORAS

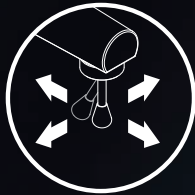

FÁCIL
ACCIONAMIENTO

LLAVES A PARED

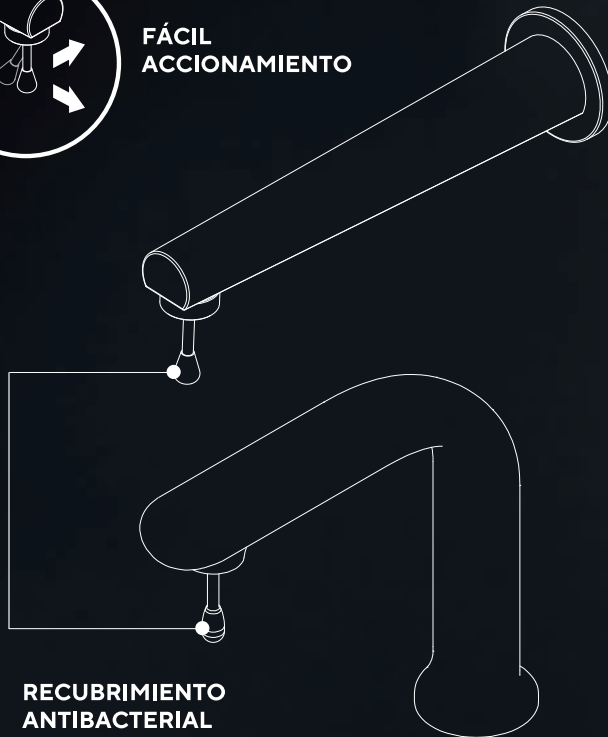

RECUBRIMIENTO
ANTIBACTERIAL
EN SISTEMA PUSH



RECUBRIMIENTO
ANTIBACTERIAL
EN LA PERILLA



Productos con uso
eficiente de agua.

NMX

NMX-C-415-ONNCC-2015 "Industria de la
Construcción - Válvulas y Grifos para
Agua - Especificaciones y Métodos de ensayo".

*Sólo aplica con productos Ecolvex:
TV105-2, TV122-1.9 y TV121-1.9



Garantía Helvex en
acabado cromo de 10 años
y resto de acabados 2 años.

HELVEX

Garantía de Calidad

**AHORRA EN PROMEDIO 5,986 LITROS
DE AGUA AL AÑO POR LLAVE**

Los datos son comparados con el flujo máximo permitido por la NOM.

LLAVES ECONOMIZADORAS Y TEMPORIZADORAS

TV-100

Cromo

\$ 3,874.00

Llave de lavabo economizadora a pared.



Dimensiones:
vista frontal

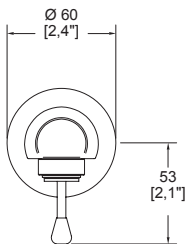

Dimensiones:
vista lateral

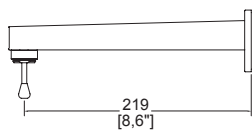

Seguro antirrobo.
Presión mínima requerida 0.25 kg/cm².
Consumo de agua: 5 L/min.

Perilla con recubrimiento antibacterial.



CR

TV-105

Cromo

\$ 3,692.00

Llave de lavabo economizadora.



Dimensiones:
vista frontal

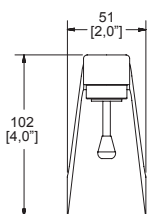

Dimensiones:
vista lateral

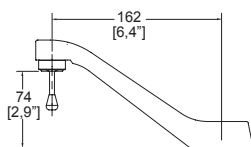

Seguro antirrobo.
Presión mínima requerida 0.20 kg/cm².
Consumo de agua: 5 L/min.

Perilla con recubrimiento antibacterial.



CR

NMX NMX-C-415-ONNCCE-2015



STALA

TV-106

Cromo

\$ 3,479.00

Llave de lavabo
economizadora.



Dimensiones:
vista frontal

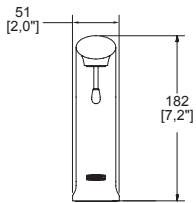

Dimensiones:
vista lateral

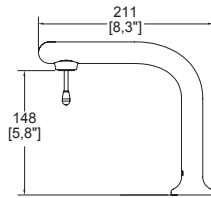

Presión mínima requerida 0.25 kg/cm².
Consumo de agua: 3 L/min.

Perilla con recubrimiento antibacterial.



CR

TV-121

Cromo

\$ 4,452.00

Llave de lavabo
temporizadora a pared.

**Modelo ahorrador
TV121-1.9**



Dimensiones:
vista frontal

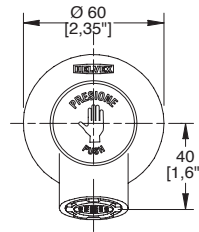

Dimensiones:
vista lateral

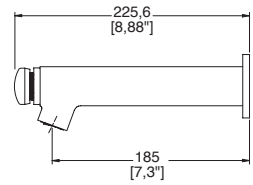

Cierre automático.

Presión mínima requerida 0.25 kg/cm².

Consumo de agua: 8.3 L/min.

Botón con recubrimiento antibacterial.



CR

TV-122

Cromo

\$ 4,245.00

Llave de lavabo
temporizadora a piso.

**Modelo ahorrador
TV122-1.9**



Dimensiones:
vista frontal

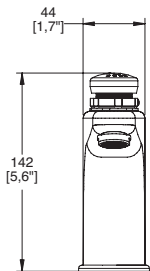

Dimensiones:
vista lateral

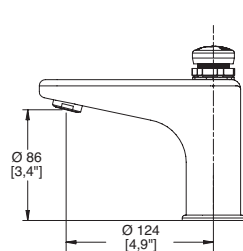

Cierre automático.

Presión mínima requerida 0.25 kg/cm².

Consumo de agua: 8.3 L/min

Botón con recubrimiento antibacterial.



CR

NMX NMX-C-415-ONNCCE-2015





ACABADOS

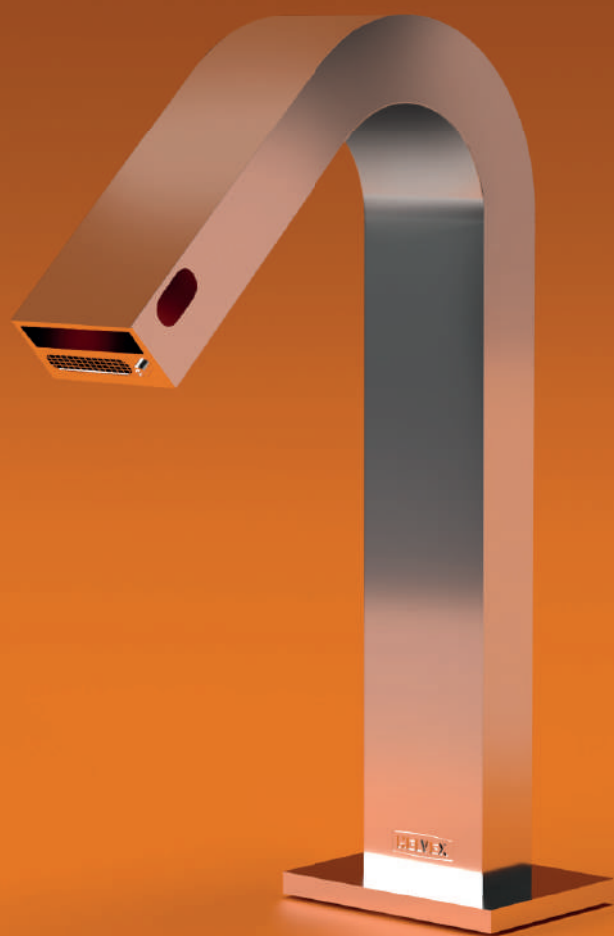

CR
Cromo

LLAVES ELECTRÓNICAS



Llaves electrónicas de sensor.

- Máxima higiene (sistema electrónico que detecta la presencia del usuario).
- Ahorro significativo de agua (proporciona la cantidad necesaria para una limpieza completa).



Llaves electrónicas de proximidad.

- Sin sensores aparentes (la presencia del usuario cierra el circuito electrónico de la llave).
- Garantizan un óptimo consumo de agua.
- Mayor eficiencia energética.



Llaves electrónicas de proximidad a pared.

Tecnologías innovadoras y certificaciones:

Llaves electrónicas que cuentan con un tiempo de activación programado para evitar el desperdicio de agua.



Llaves electrónicas de proximidad que se activan al acercar las manos alrededor de la llave y se cierra al retirar las manos.

NOM

Todas nuestras llaves electrónicas cumplen con la Norma Oficial Mexicana NOM-001-SCFI-2018 "Aparatos electrónicos - Requisitos de seguridad y Métodos de Prueba".

Visite nuestra página web para consultar y descargar fichas técnicas e instructivos de instalación.
helvex.com     



LLAVES ELECTRÓNICAS



LLAVES ELECTRÓNICAS DE SENSOR A PARED

- Sensor infrarrojo.
- Distancia de detección 12 cm.
- Cuentan con un tiempo de activación programado para evitar el desperdicio de agua.

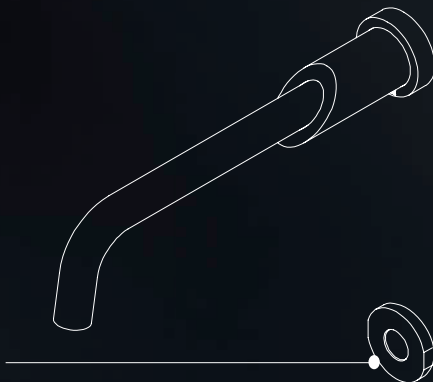

LLAVES ELECTRÓNICAS DE PROXIMIDAD

- Sin sensores aparentes.
- Se activan al acercar las manos alrededor de la llave y se cierra al retirar las manos.

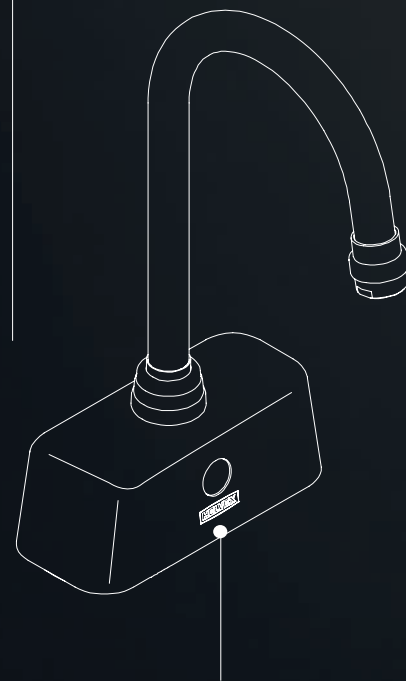

LLAVES ELECTRÓNICAS DE SENSOR

- Máxima higiene (sistema electrónico que detecta la presencia del usuario).
- Ahorro significativo de agua (proporciona la cantidad necesaria para una limpieza completa).

HELVEX

Garantía de Calidad



ECOLVEX

Productos con uso
eficiente de agua.



Garantía Helvex en acabado cromo de 10 años
y resto de acabados 2 años.

LLAVE DE LAVABO ELECTRÓNICA DE SENSOR

FUSIÓN TV-002

Cromo

\$ 16,334.00



Salida electrónica con dosificador de jabón.

Dimensiones:
vista frontal

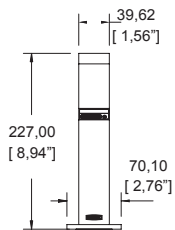

Dimensiones:
vista cenital

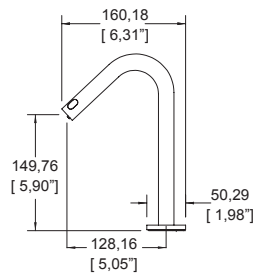

Opera con un sensor infrarrojo de baterías o corriente.



CR

Sensor infrarrojo lateral para salida de jabón líquido



Sensor infrarrojo frontal para la salida del agua



LLAVES DE LAVABO ELECTRÓNICAS

NIMBUS

TV-190

Cromo



Modelo ahorrador
TV190-1.9

\$ 16,145.00

Llave de lavabo electrónica de proximidad.



De baterías de litio 6V



Dimensiones:
vista frontal

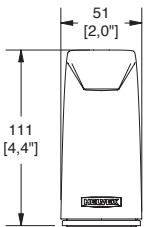

Dimensiones:
vista lateral

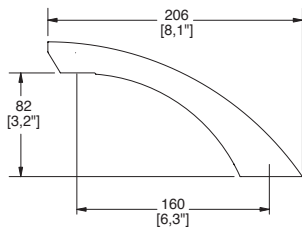

Tecnología de proximidad.
Presión mínima requerida 0.60 kg/cm².



CR

LLAVE DE LAVABO ELECTRÓNICA DE SENSOR A PARED

NUVA

TV-200

Cromo



De baterías alcalinas AA

\$ 15,545.00



NUVA

TV-200-C

Cromo



De corriente

\$ 16,379.00



Presión mínima requerida 0.40 kg/cm².



CR

Dimensiones:
vista frontal

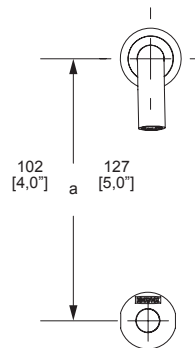

Dimensiones:
vista lateral

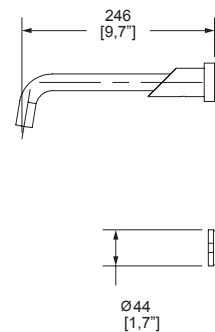

NOM NOM-001-SCFI-2018

LLAVES DE LAVABO ELECTRÓNICAS DE SENSOR

ARGOS

TV-296

Cromo

 De baterías alcalinas AA

\$ 14,221.00

 Modelo ahorrador TV296-1.9



ARGOS

TV-296-C

Cromo

 De corriente

\$ 14,982.00

 Modelo ahorrador TV296-C-1.9



Presión mínima requerida 0.40 kg/cm².

CR

Dimensiones:
vista frontal

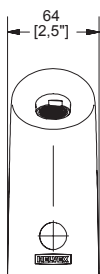

Dimensiones:
vista lateral

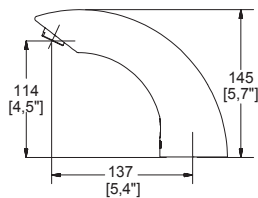

ALFA

TV-297

Cromo

 De baterías alcalinas AA

\$ 15,545.00

 Modelo ahorrador TV297-1.9



ALFA

TV-297-C

Cromo

 De corriente

\$ 16,379.00

 Modelo ahorrador TV297-C-1.9



Presión mínima requerida 0.40 kg/cm².

CR

Dimensiones:
vista frontal

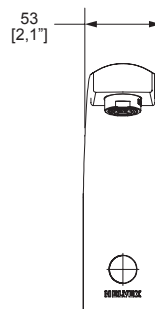

Dimensiones:
vista lateral

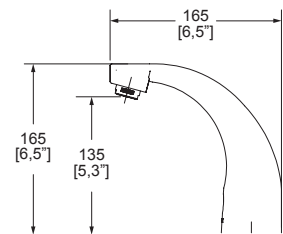

NOM NOM-001-SCFI-2018

OMEGA
TV-298

Cromo

 De baterías
de litio 6V

\$ 15,545.00

 Modelo ahorrador
TV298-1.9

OMEGA
TV-298-C

Cromo

 De corriente

\$ 16,379.00

 Modelo ahorrador
TV298-C-1.9



Presión mínima requerida 0.40 kg/cm².



CR

Dimensiones:
vista frontal

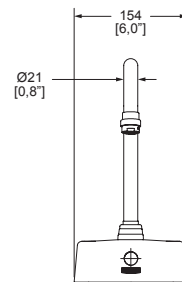

Dimensiones:
vista lateral

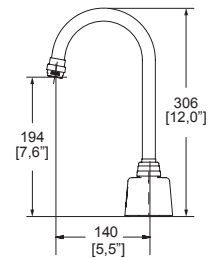

NOM NOM-001-SCFI-2018

LLAVE ELECTRÓNICA DE SENSOR CON AIREADOR OCULTO

LÍQUIDA TV-302

Cromo

 **De baterías**
alcalinas AA

\$ 15,545.00

 **Modelo ahorrador**
TV302-1.5

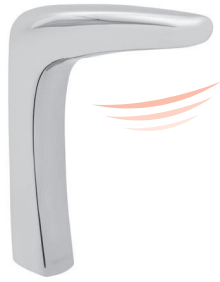

LÍQUIDA TV-302-C

Cromo

 **De corriente**

\$ 16,379.00

 **Modelo ahorrador**
TV302-C-1.5



Presión mínima requerida 0.80 kg/cm².

CR

Dimensiones:
vista frontal

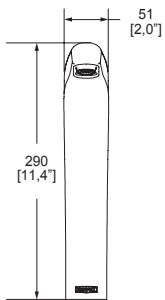

Dimensiones:
vista lateral

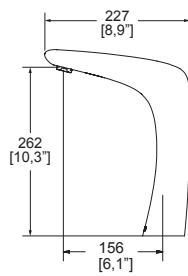

NOM NOM-001-SCFI-2018

FORZA

TV-304

Cromo

 **De baterías**
alcalinas AA

\$ 14,221.00

 **Modelo ahorrador**
TV304-1.5



FORZA

TV-304-C

Cromo

 **De corriente**

\$ 14,982.00

 **Modelo ahorrador**
TV304-C-1.5



Presión mínima requerida 0.80 kg/cm².

CR

Dimensiones:
vista frontal

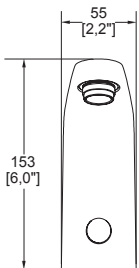

Dimensiones:
vista lateral

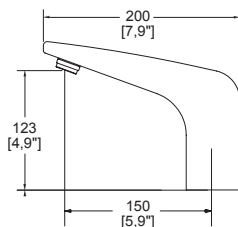

TV-305

Cromo

 **De baterías**
alcalinas AA

\$ 12,087.00



Dimensiones:
vista frontal

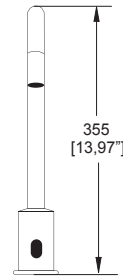

Dimensiones:
vista lateral

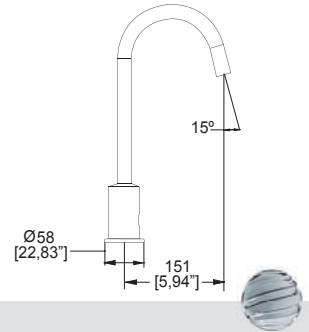

Cuello de gancho giratorio.
Presión mínima requerida 0.50 kg/cm².

CR







NOM NOM-001-SCFI-2018

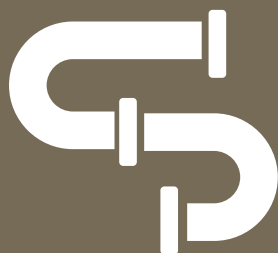

ACONDICIONADOR DE **AGUAS DURAS**



Visite nuestra página web para consultar y descargar
fichas técnicas e instructivos de instalación.
helvex.com     

ACONDICIONADOR DE AGUAS DURAS

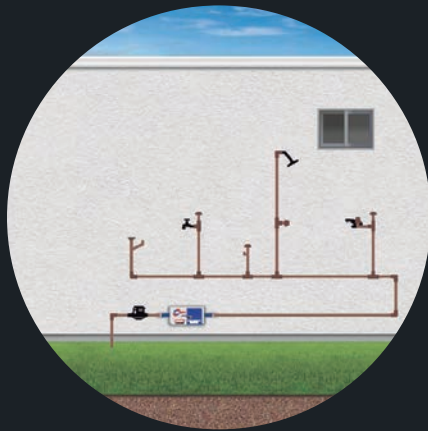

En un sistema directo sin sarro se coloca saliendo del medidor.

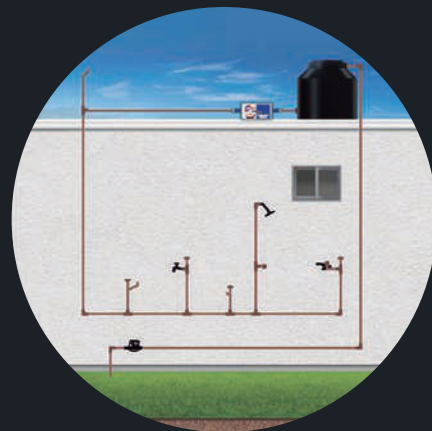

En un sistema de gravedad con tinaco, el sistema se coloca a la salida del tinaco.

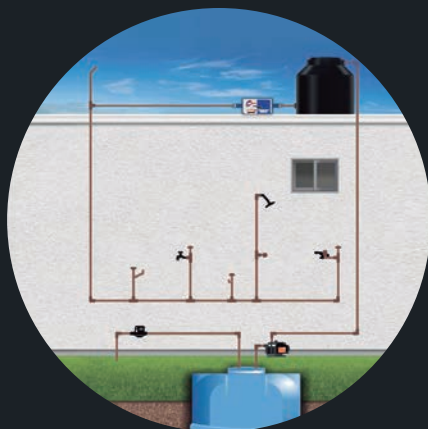

En un sistema de gravedad con tinaco y sistema se coloca a la salida del tinaco.

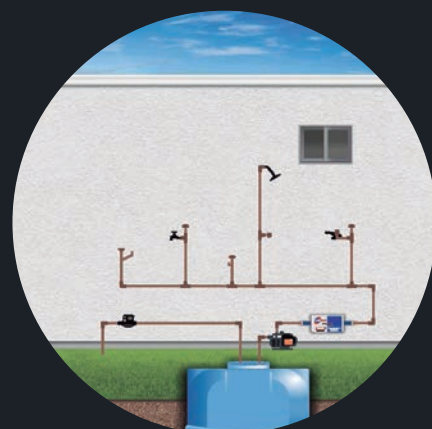

En un sistema asistido con hidroneumático o presurizador es conveniente colocar el sinSarro a la salida de la bomba presurizadora.

HELVEX

Garantía de Calidad



SS-1
Blanco

\$ 7,781.00



Acondicionador de aguas duras. De corriente **Sinsarro**.

Dimensiones:
vista frontal

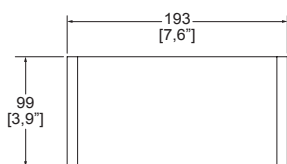

Dimensiones:
vista lateral



¿COMO FUNCIONA NUESTRO SISTEMA DE TRATAMIENTO DEL AGUA HELVEX?

A base de impulsos electrónicos que remueven, protegen e impiden la acumulación de cal y óxido en las tuberías.

BENEFICIOS

- **IMPIDE** nuevas acumulaciones.
- **NO** altera la **CALIDAD DEL AGUA**.
- **AHORRO** de hasta un 50% en el consumo de jabones, detergentes y shampoos.
- Evita la **ACUMULACIÓN DE MANCHAS DE SARRO** en llaves, muebles de baño, tinas, cortinas y cancelos.
- Se instala **DIRECTAMENTE EN LA TUBERÍA** de alimentación de agua, después del contador y antes de que se ramifique la tubería en el calentador u otra instalación hidráulica.
- Para uso **RESIDENCIAL y COMERCIAL**.

NOM NOM-001-SCFI-2018

Los precios incluyen IVA

205

HELVEX
Garantía de Calidad

ACABADOS



CR
Cromo



AC
Acero
Pulido



B
Blanco



AL
Aluminio



AI
Acero
Inoxidable



S/AI
Satin/ Acero
inoxidable

ACCESORIOS INSTITUCIONALES



Secadores de manos.

- Ahorro en el consumo de papel toalla.
- Nivel de ruido de 65 decibeles equivalente al sonido de un restaurant (ningún daño auditivo), muy bajo comparado con otros (90 decibeles, equivalente al ruido de una máquina para cortar césped, posible daño auditivo con exposición prolongada).
- Menor consumo de energía (tiempo de secado de 10 a 15 segundos).
- Sistema de apagado automático que evita quemaduras.
- Certificados de conformidad con la NOM-003-SCFI-2014 "Productos eléctricos – Especificaciones de seguridad".



Barras de seguridad.

- Diámetro para una adecuada sujeción del usuario.
- Distancia a la pared que evita el deslizamiento de la mano hacia adentro.
- Acero Inoxidable tipo 304 calibre 18.
- Soportan un peso estático de hasta 136 kg. por un periodo de 5 minutos con una recuperación total.
- Utilizadas en el **80% de los hoteles en México.**



Dosificadores de jabón.

- Producto higiénico operado por un sensor electrónico.
- Contenedor rellenable que evita la compra de consumibles como cartuchos.
- Funciona con cualquier tipo y densidad de jabón líquido o gel antibacterial.
- Certificados de conformidad con la NOM-001-SCFI-2018 "Aparatos electrónicos – Requisitos de seguridad y Métodos de Prueba".



Diversidad de accesorios para baños Institucionales.

- Agarradera para tina.
- Portapapel antirrobo.
- Repisa.
- Destapador.
- Tendedero retráctil.
- Gancho portamuletas.

Visite nuestra página web para consultar y descargar
fichas técnicas e instructivos de instalación.
helvex.com     



ACCESORIOS INSTITUCIONALES



SECADORES DE MANOS

- Ahorro en el consumo de papel toalla.
- Nivel de ruido de 65 decibeles.
- Menor consumo de energía.
(tiempo de secado de 10 a 15 segundos).
- Sistema de apagado automático.

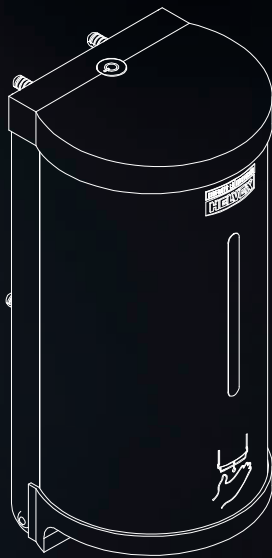

DOSIFICADORES DE JABÓN

- Producto higiénico operado por un sensor electrónico.
- Contenedor rellenable.
- Funciona con cualquier tipo de jabón líquido.

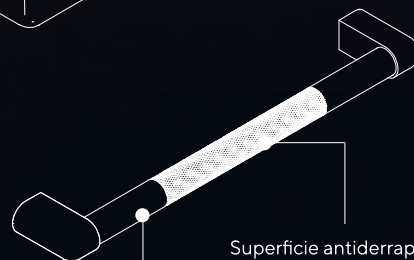
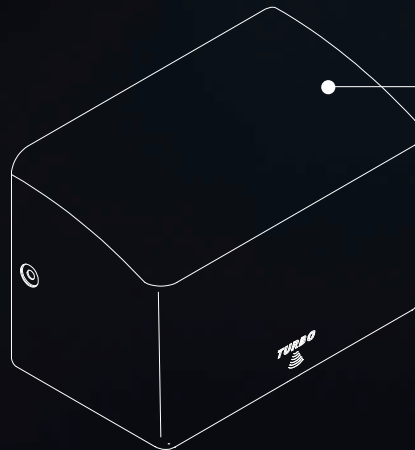

Superficie antiderrapante.
(BR-470)

BARRAS DE SEGURIDAD

- Diámetro para una adecuada sujeción del usuario.
- Soportan un peso estático de hasta 136 kg. por un período de 5 minutos con una recuperación total.
- **FABRICADAS DE ACERO INOXIDABLE.**

HELVEX®

Garantía de Calidad

17

Cromo

\$ 1,486.00

Portapapel con repisa para celular.



Dimensiones:
vista frontal

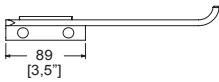

Dimensiones:
vista cenital

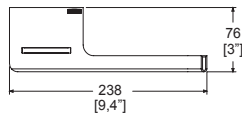

Acabado.



CR



B-305-S

Acero inoxidable

\$ 1,860.00

Barra recta de seguridad
305 mm Al.



Dimensiones:
vista frontal

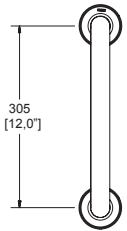

Dimensiones:
vista lateral

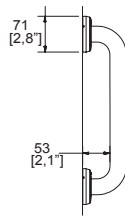

Carga máxima aplicada 136 kg máximo,
por un periodo de 5 minutos.



B-470-S

Acero inoxidable

\$ 1,860.00

Barra recta de seguridad
470 mm Al.



Dimensiones:
vista frontal

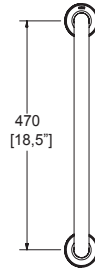

Dimensiones:
vista lateral



Carga máxima aplicada 136 kg máximo,
por un periodo de 5 minutos.



B-610-S

Acero inoxidable

\$ 1,971.00

Barra recta de seguridad
610 mm Al.



Dimensiones:
vista frontal

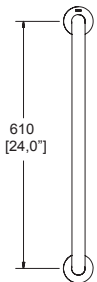

Dimensiones:
vista lateral



Carga máxima aplicada 136 kg máximo,
por un periodo de 5 minutos.



B-700-S

Acero inoxidable

\$ 2,021.00

Barra recta de seguridad
700 mm Al.



Dimensiones:
vista frontal

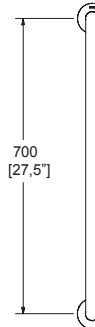

Dimensiones:
vista lateral

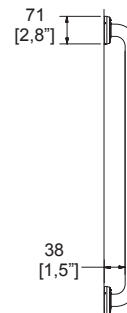

Carga máxima aplicada 136 kg máximo,
por un periodo de 5 minutos.



B-062-S

Acero inoxidable

\$ 4,223.00

Barra angular Hockey
810 mm x 350 mm
derecha AI.



Dimensiones:
vista frontal

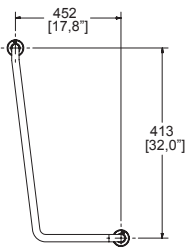

Dimensiones:
vista lateral

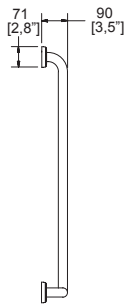

Carga máxima aplicada 136 kg máximo,
por un periodo de 5 minutos.

AI

B-064-S

Acero inoxidable

\$ 4,223.00

Barra angular Hockey
810 mm x 350 mm
izquierda AI.



Dimensiones:
vista frontal

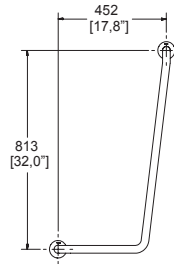

Dimensiones:
vista lateral

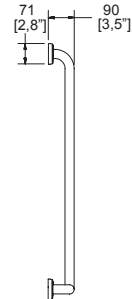

Carga máxima aplicada 136 kg máximo,
por un periodo de 5 minutos.

AI

B-066-S

Acero inoxidable

\$ 3,167.00

Barra angular Boomerang
305 mm x 305 mm
izquierda AI.



Dimensiones:
vista frontal

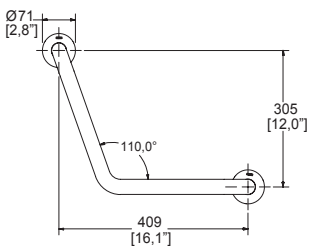

Dimensiones:
vista lateral



Carga máxima aplicada 136 kg máximo,
por un periodo de 5 minutos.

AI

BR-470

Cromo

\$ 3,099.00

Barra de seguridad
residencial
antiderrapante.



Dimensiones:
vista frontal

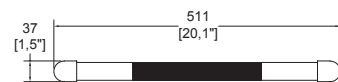

Dimensiones:
vista cenital

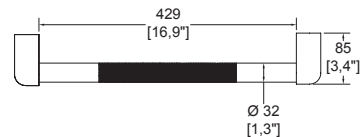

Resistencia de carga: 100 kg en muro de concreto.

CR

SECADORES DE MANOS

MB-1011

Blanco

\$ 9,142.00

Secador de Manos.
Con botón accionador.



Dimensiones:
vista frontal

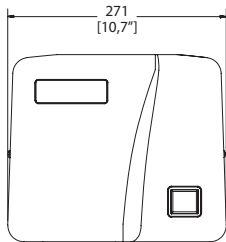

Dimensiones:
vista lateral

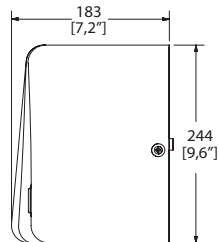

De corriente. 

Tiempo de secado de 30 a 35 segundos.

Blanco

MB-1012

Blanco

\$ 14,631.00

Secador de Manos
TURBO.
Con sensor.



Dimensiones:
vista frontal

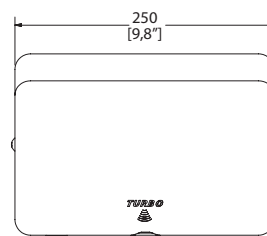

Dimensiones:
vista lateral

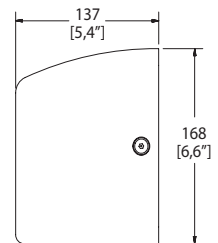

De corriente. 

Tiempo de secado de 10 a 15 segundos.

Blanco

MB-1012-AI

Acero inoxidable

\$ 18,106.00

Secador de Manos
TURBO.
Con sensor.



Dimensiones:
vista frontal

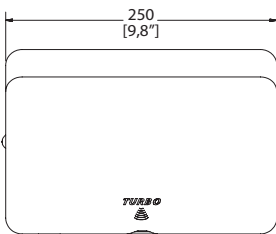

Dimensiones:
vista lateral

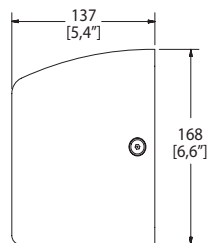

De corriente. 

Tiempo de secado de 10 a 15 segundos.

AI

MB-1012-AIB

Acero inoxidable pulido

\$ 18,106.00

Secador de Manos
TURBO.
Con sensor.



Dimensiones:
vista frontal

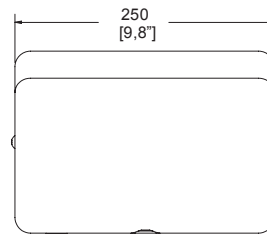

Dimensiones:
vista lateral

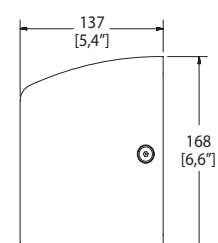

De corriente. 

Tiempo de secado menor a 15 segundos.

AI

NOM NOM-003-SCFI-2014

MB-1100

Aluminio

\$ 6,636.00

Dosificador electrónico con sensor para jabón líquido.



Dimensiones: vista frontal

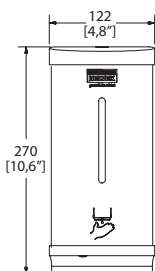

Dimensiones: vista lateral

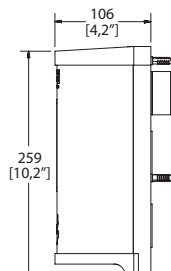

Requiere baterías alcalinas AA.



AL

MB-1101

Aluminio

\$ 7,773.00

Dosificador electrónico con sensor para jabón de espuma.



Dimensiones: vista frontal

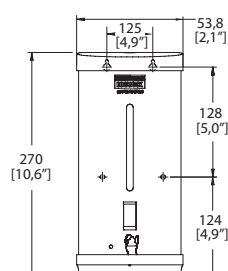

Dimensiones: vista lateral

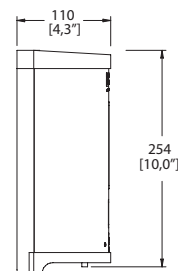

Requiere baterías alcalinas AA.



AL

MB-1102-AIB

Acero pulido de alto brillo

\$ 6,636.00

Dosificador electrónico con sensor para jabón líquido.



Dimensiones: vista frontal

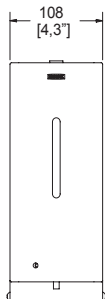

Dimensiones: vista lateral

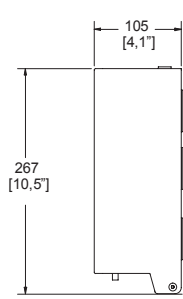

Requiere baterías alcalinas AA.



AP

MB-1103-AIB

Acero pulido de alto brillo

\$ 7,773.00

Dosificador electrónico con sensor para jabón de espuma.



Dimensiones: vista frontal

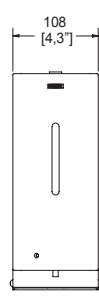

Dimensiones: vista lateral

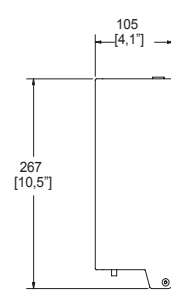

Requiere baterías alcalinas AA.



AP

NOM NOM-001-SCFI-2018

PEDESTAL PARA DOSIFICADORES DE JABÓN O GEL

PD-01-AI

Satín, acero inoxidable

\$ 3,918.00



Dimensiones:
vista frontal

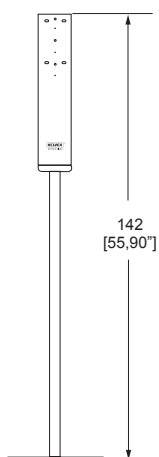

Dimensiones:
vista lateral

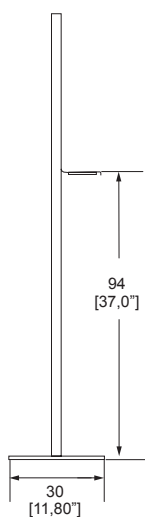

Compatibilidad con dosificadores:
MB-1100, MB-1101, MB-1102-AIB y MB-1103-AIB.



S/AI



ACABADOS



CR
Cromo

FLUXÓMETROS



Fluxómetros para W.C. y mingitorio de manija.



Fluxómetros para W.C. y mingitorio de pedal.



Fluxómetros para W.C. de cuerpo oculto de pedal.



Fluxómetros electrónicos para W.C. y mingitorio.

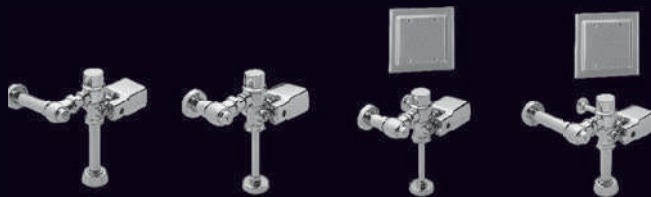

Tecnologías innovadoras y certificaciones:

Contamos con Fluxómetros de 6, 4.8, 3, 1 y 0.5 litros de agua por descarga.

Y ahora con 3.5 litros para tazas para fluxómetros NAO, NAO17 y NAO a pared.



NOM

Todos nuestros fluxómetros cumplen con la Norma Oficial Mexicana NOM-002-CONAGUA-2021 "Aparatos y accesorios de uso sanitario".

Visite nuestra página web para consultar y descargar fichas técnicas e instructivos de instalación.
helvex.com     



FLUXÓMETROS



FLUXÓMETROS ELECTRÓNICOS PARA WC Y MINGITORIOS

- Con sensor electrónico de corriente o de batería.



- Descarga de 3,5, 4,8 y 6 L en Taza flux. Descarga de 0,5, 1 y 3 L para mingitorio.

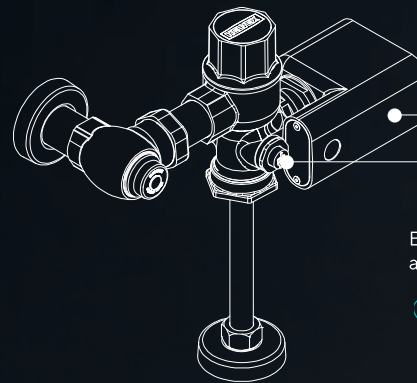

Botón con recubrimiento antibacterial.



FLUXÓMETRO DE CUERPO OCULTO DE PEDAL PARA WC

- Spud de 38 mm.
- 4.8 LPD.

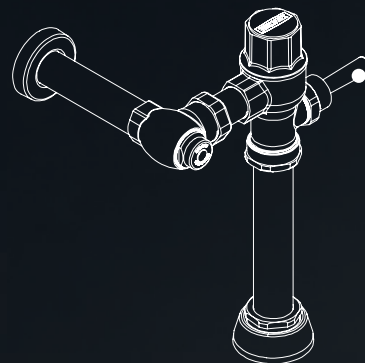
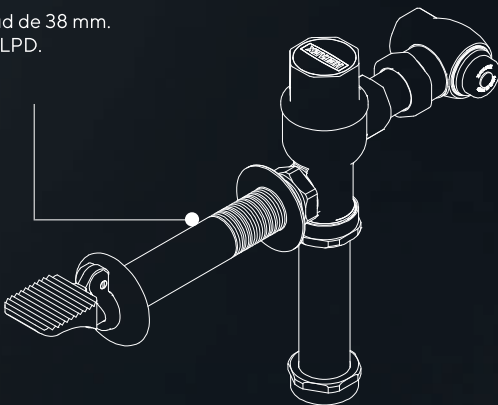

FLUXÓMETROS PARA WC Y MINGITORIO DE PALANCA

- Palanca con recubrimiento antibacterial.



- Descarga de 3,5, 4,8 y 6 L en Taza flux. Descarga de 0,5, 1 y 3 L para mingitorio.

HELVEX
Garantía de Calidad



Productos con uso eficiente de agua.



Garantía Helvex en acabado cromo de 10 años y resto de acabados 2 años.



110-WC-4.8

Cromo

\$ 7,604.00



Modelo ahorrador

Fluxómetro de manija para taza flux, **spud de 38 mm** **4.8 L** por descarga.

Presión mínima requerida 1.00 kg/cm²

110-38

Cromo

\$ 7,604.00

Fluxómetro de manija para taza flux, **spud de 38 mm** **6 L** por descarga.

Presión mínima requerida 1.00 kg/cm².



110-38-3.5

Cromo

\$ 7,604.00



Modelo ahorrador

Fluxómetro de manija para taza flux Nao, Nao17 y Nao a pared, **spud de 38 mm** **3.5 L** por descarga.

Presión mínima requerida 2.00 kg/cm².

Manija con recubrimiento antibacterial.



CR

Dimensiones:
vista frontal

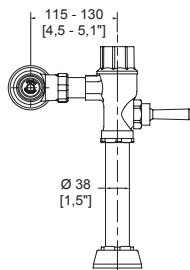

Dimensiones:
vista lateral

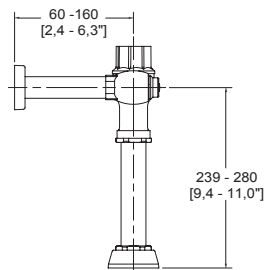

NOM NOM-002-CONAGUA-2021

117-38

Cromo

\$ 8,008.00

Fluxómetro de manija para taza flux, **spud de 38 mm** **6 L** por descarga, niple recto de 60 cm.

Presión mínima requerida 1.00 kg/cm².



Dimensiones:
vista frontal

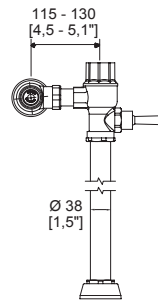

Dimensiones:
vista lateral

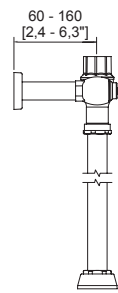

Manija con recubrimiento antibacterial.



CR



FLUXÓMETROS MECÁNICOS DE PEDAL EXPUESTO PARA INODORO

310-WC-4.8

Cromo

\$ 9,146.00



Flujómetro de pedal expuesto para taza flux, **spud de 38 mm** **4.8 L** por descarga.

Presión mínima requerida 1.00 kg/cm².

310-38

Cromo

\$ 9,146.00

Flujómetro de pedal expuesto para taza flux, **spud de 38 mm** **6 L** por descarga.

Presión mínima requerida 1.00 kg/cm².



310-38-3.5

Cromo

\$ 9,146.00



Flujómetro de pedal expuesto para taza flux Nao, Nao17 y Nao a pared, **spud de 38 mm** **3.5 L** por descarga

Presión mínima requerida 2.00 kg/cm²



Acabado.

CR

Dimensiones:
vista frontal

Dimensiones:
vista lateral

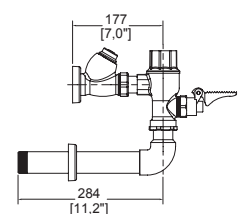
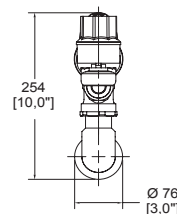

NOM NOM-002-CONAGUA-2021

FLUXÓMETROS MECÁNICOS DE PEDAL EXPUESTO PARA MINGITORIO

310-19-0.5

Cromo

\$ 9,146.00



Flujómetro de pedal expuesto para mingitorio, **spud de 19 mm** **0.5 L** por descarga.

Presión mínima requerida 1.00 kg/cm².

310-19-1

Cromo

\$ 9,146.00

Flujómetro de pedal expuesto para mingitorio, **spud de 19 mm** **1 L** por descarga.

Presión mínima requerida 1.00 kg/cm².



310-19

Cromo

\$ 9,146.00

Flujómetro de pedal expuesto para mingitorio, **spud de 19 mm** **3 L** por descarga.

Presión mínima requerida 1.00 kg/cm².



Acabado.

CR

Dimensiones:
vista frontal

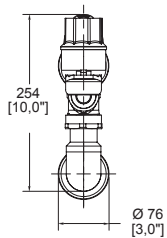

Dimensiones:
vista lateral

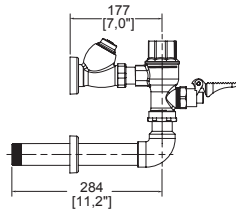

NOM NOM-002-CONAGUA-2021



FLUXÓMETROS MECÁNICOS DE MANIJA PARA MINGITORIO

185-19-0.5

Cromo

\$7,604.00



Flujómetro de manija para mingitorio, **spud de 19 mm** **0.5 L** por descarga.

Presión mínima requerida 1.00 kg/cm²

185-19-1

Cromo

\$7,604.00

Flujómetro de manija para mingitorio, **spud de 19 mm** **1 L** por descarga.

Presión mínima requerida 1.00 kg/cm²



185-19

Cromo

\$7,604.00

Flujómetro de manija para mingitorio, **spud de 19 mm** **3 L** por descarga.

Presión mínima requerida 1.00 kg/cm²

Manija con recubrimiento antibacterial.



CR

Dimensiones:
vista frontal

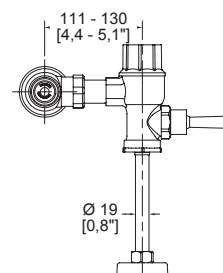

Dimensiones:
vista lateral

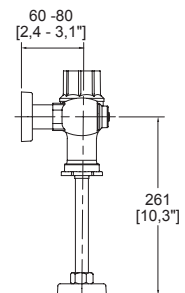

NOM NOM-002-CONAGUA-2021

FLUXÓMETRO MECÁNICO DE PEDAL PARA INODORO DE CUERPO OCULTO

312-WC-4.8

Cromo

\$ 9,127.00



Modelo ahorrador

Fluxómetro de pedal expuesto para taza flux cuerpo oculto, **spud de 38 mm** **4.8 L** por descarga.



Dimensiones:
vista frontal

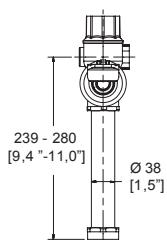

Dimensiones:
vista lateral

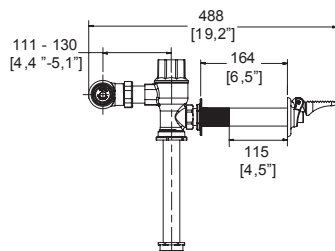

Presión mínima requerida 1.00 kg/cm².



CR



NOM NOM-002-CONAGUA-2021

FLUXÓMETROS ELECTRÓNICOS DE CORRIENTE PARA INODOROS

FC-110-WC-4.8

Cromo

\$ 20,435.00



Flujómetro de sensor electrónico de corriente para taza flux, **spud de 38 mm.**
4.8 L por descarga.

Presión mínima requerida
1.00 kg/cm².



FC-110-38-3.5

Cromo

\$ 20,435.00



Flujómetro de sensor electrónico para taza flux Nao, Nao17 y Nao a pared, **spud de 38 mm**
3.5 L por descarga.

Presión mínima requerida
2.00 kg/cm².



Botón con recubrimiento antibacterial.



CR

De corriente.



Dimensiones:
vista frontal

Dimensiones:
vista lateral

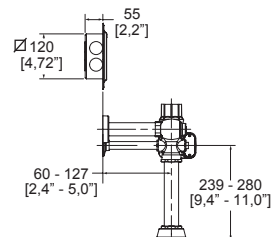
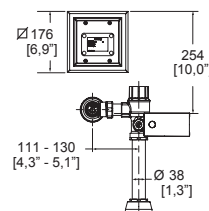

NOM NOM-002-CONAGUA-2021

FLUXÓMETROS ELECTRÓNICOS DE CORRIENTE PARA MINGITORIOS

FC-185-19-0.5

Cromo

\$ 20,435.00



Modelo ahorrador

Fluxómetro de sensor electrónico de corriente para mingitorio, **spud de 19 mm.** **0.5 L** por descarga.



FC-185-19-1

Cromo

\$ 20,435.00

Fluxómetro de sensor electrónico para mingitorio, **spud de 19 mm** **1 L** por descarga



FC-185-19

Cromo

\$ 20,435.00

Fluxómetro de sensor electrónico para mingitorio, **spud de 19 mm.** **3 L** por descarga.

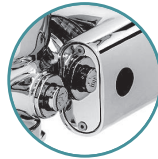

Botón con recubrimiento antibacterial.



CR

Presión mínima requerida 1.00 kg/cm².

De corriente.



Dimensiones:
vista frontal

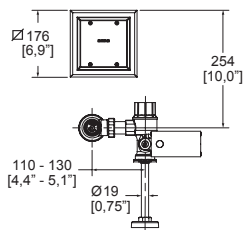

Dimensiones:
vista lateral

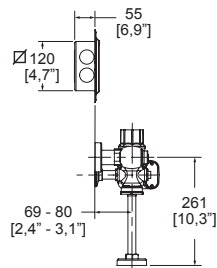

NOM NOM-002-CONAGUA-2021



FLUXÓMETROS ELECTRÓNICOS DE BATERÍA PARA INODOROS

FB-110-WC-4.8

Cromo

\$ 20,435.00



Flujómetro de sensor electrónico de baterías para taza flux, **spud de 38 mm.** **4.8 L** por descarga.

Presión mínima requerida 1.00 kg/cm².



FB-110-38

Cromo

\$ 20,435.00

Flujómetro de sensor electrónico de baterías para taza flux, **spud de 38 mm.** **6 L** por descarga.

Presión mínima requerida 1.00 kg/cm².



FB-110-38-3.5

Cromo

\$ 20,435.00



Flujómetro de sensor electrónico de baterías para taza flux Nao, Nao17 y Nao a pared, **spud de 38 mm.** **3.5 L** por descarga.

Presión mínima requerida 2.00 kg/cm².

Botón con recubrimiento antibacterial.



CR

Requiere baterías alcalinas AA.



Dimensiones:
vista frontal

Dimensiones:
vista lateral

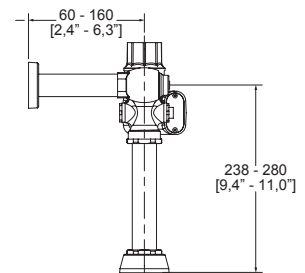
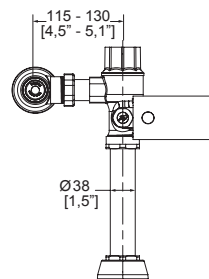

NOM NOM-002-CONAGUA-2021

FLUXÓMETROS ELECTRÓNICOS DE BATERÍA PARA MINGITORIOS

FB-185-19-0.5

Cromo

\$ 20,435.00



Modelo ahorrador

Fluxómetro de sensor electrónico de baterías para mingitorio **spud de 19 mm.**
0.5 L por descarga.

Presión mínima requerida 1.00 kg/cm².



FB-185-19-1

Cromo

\$ 20,435.00

Fluxómetro de sensor electrónico de baterías para mingitorio **spud de 19 mm.**
1 L por descarga.

Presión mínima requerida 1.00 kg/cm².



FB-185-19

Cromo

\$ 20,435.00

Fluxómetro de sensor electrónico de baterías para mingitorio **spud de 19 mm.**
3 L por descarga.

Presión mínima requerida 1.00 kg/cm².



Botón con recubrimiento antibacterial.



CR

Requiere baterías alcalinas AA.



Dimensiones:
vista frontal

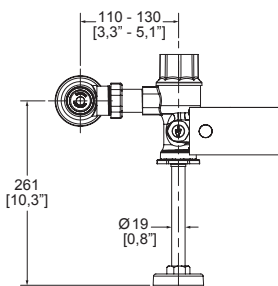

Dimensiones:
vista lateral

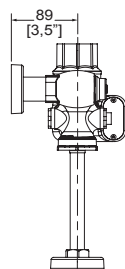

NOM NOM-002-CONAGUA-2021

ACABADOS



Ébano



Marfil



Blanco

MUEBLES SANITARIOS Y LAVABOS

Más allá de su excelente funcionalidad, garantizada por la histórica calidad que nos acompaña, nuestros muebles sanitarios son reflejo de elegancia, estilo y confort expresado a través de texturas suaves, líneas curvas y delgadas, cuerpos sólidos y fuertes y un acabado tan brillante que te deslumbrará.

La labor de madurar una línea de producción y generar diseños más eficientes y atractivos, han sido retos que hoy rinden frutos, te invitamos a conocer nuestros nuevos modelos de muebles sanitarios, diseñados para brindarte el mayor confort y una mejor experiencia.



WC.



One Piece.



Tazas flux.



Asientos.





Mingitorios.



Lavabos.



Visite nuestra página web para consultar y descargar
fichas técnicas e instructivos de instalación.
helvex.com     



MUEBLES SANITARIOS Y LAVABOS



Cerámica al alto brillo

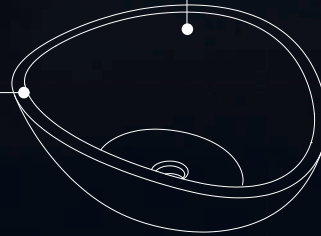

Diversidad de diseños, adaptables a las necesidades: Sobreponer, bajocubierta y sobrecubierta.

GRUESO
ESPESOR



ECOLVEX

Descargas de 3.8 y 4.8 L

Sistemas de descarga:
LIMPIEZA TOTAL
¡NO SE TAPAN!



VÓRTICE



TURVEX

Modelos disponibles de altura tradicional y altura confortable.



Trampa esmaltada
cero residuos, cero
proliferación de bacterias.



Mingitorios sin consumo de agua, con sistema **TDS2** QUE EVITA LOS MALOS OLORES

HELVEX

Garantía de Calidad

65
años de
garantía en
cerámica

OP RIVOLI PLUS 4.8 LPD

- Inodoro ONE PIECE RIVOLI PLUS elongado.
- Una sola pieza.
- Taza de altura comfortable con trampa **oculta**.
- **Descarga de 4.8 LPD.**
- Botón accionador.
- **Sistema Turvex.**
Cuenta con **3 jets** para una limpieza total.
- **Incluye asiento de cierre lento con antibacterial.** 

OP RIVOLI PLUS



Color Blanco

\$ 11,919.00

Dimensiones:
vista frontal

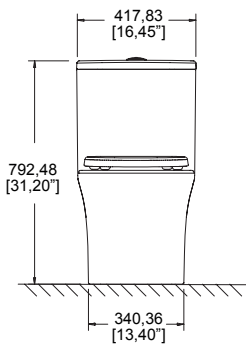

Dimensiones:
vista lateral

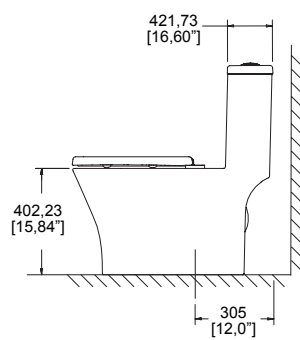

Efecto Turvex



Taza alargada



Trampa oculta



Grado ecológico



Antibacterial



Cierre lento



Mayor altura

NOM NOM-005-CONAGUA-1996

Los precios incluyen IVA

225

HELVEX
Garantía de Calidad





65
Años de garantía
en cerámica

PREMIO
NACIONAL DE DISEÑO
MX
DISEÑAMÉXICO
2019

OP CAPRI PLUS 4.8 LPD

- Inodoro **ONE PIECE CAPRI PLUS** cuadrado.
- Una sola pieza.
- Taza de altura confortable con trampa **oculta**.
- **Descarga de 4.8 LPD.**
- **Sistema Turvex.**
Cuenta con **3 jets** para una limpieza total.
- Botón accionador.
- **Incluye asiento de cierre lento con antibacterial.** 

OP CAPRI PLUS



Color Blanco

\$ 11,919.00

Dimensiones:
vista frontal

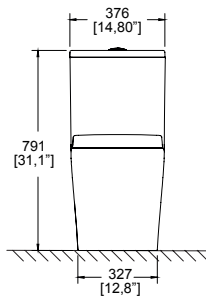

Dimensiones:
vista lateral

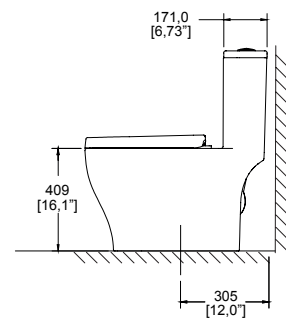

Efecto Turvex



Trampa oculta



Antibacterial



Cierre lento



Mayor altura



Grado
ecológico

NOM NOM-005-CONAGUA-1996

HELVEX
Garantía de Calidad

226

Los precios incluyen IVA

65

Años de garantía en cerámica



WC MURANO 4.8 LPD

- Inodoro, taza y tanque **MURANO** elongado.
- Taza elongada de altura confortable con trampa **oculta**.
- **Descarga de 4.8 LPD.**
- Botón accionador.
- **Sistema Turvex.** Cuenta con **3 jets** para una limpieza total.
- **Incluye asiento de cierre lento con antibacterial.**



WC MURANO



Color Blanco

\$ 10,662.00

Dimensiones:
vista frontal

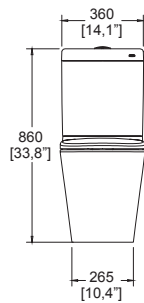

Dimensiones:
vista lateral

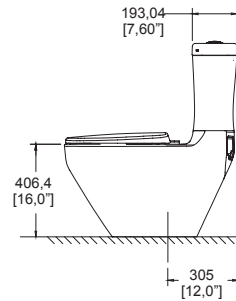

TANQUE MURANO

\$ 4,264.00



Color Blanco

TAZA MURANO

\$ 6,398.00



Color Blanco

NOM NOM-005-CONAGUA-1996



Efecto Turvex



Taza alargada



Trampa oculta



Mayor altura



Cierre lento



Antibacterial



Grado ecológico

WC MIURA16 TCC

TECNOLOGÍA CERO CONTACTO



EVITA EL CONTACTO, PREVIENE INFECCIONES

- Mayor higiene.
- Rango de detección ajustable.
- Instalación versátil, elija la posición de instalación a su gusto.

Sirve como apoyo para adultos mayores, niños o personas con capacidades diferentes que necesitan ayuda.



Sensor de baterías. Independiente, se puede instalar dentro de un rango de 5 m.

Incluye botón para descargas manuales.



Incluye asiento AT-5 de cierre lento con antibacterial.



Desaloja 1 Kg.

Altura mayor 16.6".





65
Años de garantía
en cerámica

WC MIURA16 TCC

- Inodoro, taza y tanque **MIURA16 TCC** elongado.
- Taza elongada de altura comfortable con trampa **oculta**.
- **Descarga de 4.8 LPD.**
- **Desaloja 1 Kg.**
- Botón de sensor de baterías independiente.
- Incluye botón lateral para descargas manuales.
- **Sistema Turvex.**
Cuenta con **4 jets** para una limpieza total.
- Incluye asiento **AT-5 de cierre lento con antibacterial.** 
- También compatible con ATE y ATM.

WC MIURA16 TCC



Color Blanco

\$ 13,357.00

Dimensiones:
vista frontal

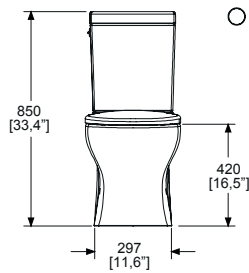

Dimensiones:
vista lateral

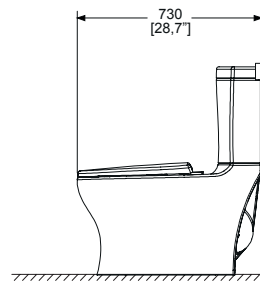

TANQUE MIURA16 TCC

Incluye botón de sensor independiente y botón manual lateral.

\$ 7,802.00



Color Blanco

TAZA MIURA16

\$ 5,555.00



Color Blanco



Efecto Turvex



Taza alargada



Trampa oculta



Mayor altura



Cierre lento



Antibacterial



Grado ecológico

NOM NOM-009-CONAGUA-2001

WC MIURA16 4.8 LPD

- Inodoro, taza y tanque **MIURA16** elongado.
- Taza elongada de altura confortable con trampa **oculta**.
- **Descarga de 4.8 LPD.**
- **Desaloja 1 kg.**
- **Sistema Turvex.**
Cuenta con **4 jets** para una limpieza total.
- Botón accionador.
- **Incluye asiento AT-5 de cierre lento con antibacterial.** 
- **También compatible con ATE Y ATM.**



WC MIURA16



\$ 9,258.00

Dimensiones:
vista frontal

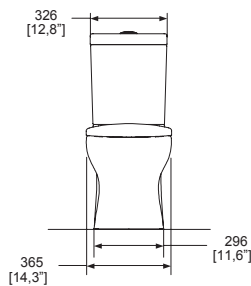

Dimensiones:
vista lateral

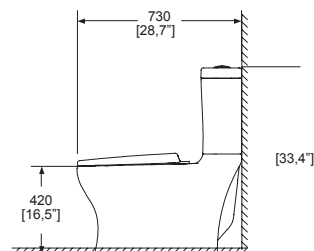

TANQUE MIURA16

\$ 3,703.00



TAZA MIURA16

\$ 5,555.00



Efecto Turvex



Taza alargada



Trampa oculta



Mayor altura



Cierre lento



Antibacterial



Grado ecológico

NOM NOM-009-CONAGUA-2001

65

Años de garantía en cerámica



WC AUSTRAL CON BOTÓN 3.8 LPD

- Ideal para espacios reducidos.
- Inodoro, taza y tanque **AUSTRAL** elongado compacto.
- Taza elongada compacta, de altura comfortable con trampa **expuesta**.
- **Descarga de 3.8 LPD.**
- **Sistema Turvex.** Para una limpieza total.
- Botón accionador.
- **No incluye asiento**, se recomiendan asientos **AT-1, AT-2 y AT-5.**

WC AUSTRAL



Color Blanco

\$ 3,969.00

Dimensiones: vista frontal

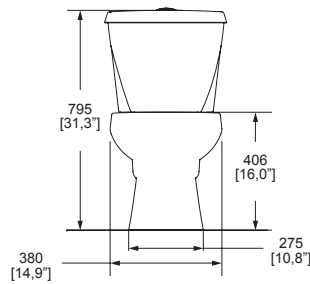

Dimensiones: vista lateral

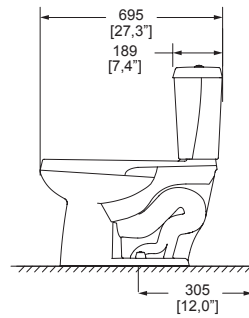

TANQUE AUSTRAL

\$ 1,825.00



Color Blanco

TAZA AUSTRAL

\$ 2,144.00



Color Blanco



Efecto Turvex



Taza alargada



Trampa expuesta



Mayor altura



Grado ecológico

NOM NOM-009-CONAGUA-2001

WC AUSTRAL CON PALANCA 3.8 LPD

- Ideal para espacios reducidos.
- Inodoro, taza y tanque **AUSTRAL** elongado compacto.
- Taza elongada compacta, de altura comfortable con trampa **expuesta**.
- **Descarga de 3.8 LPD.**
- **Sistema Turvex.**
Para una limpieza total.
- Palanca accionadora.
- **No incluye asiento**, se recomiendan asientos **AT-1, AT-2 y AT-5.**



WC AUSTRAL P



\$ 3,969.00

Dimensiones:
vista frontal

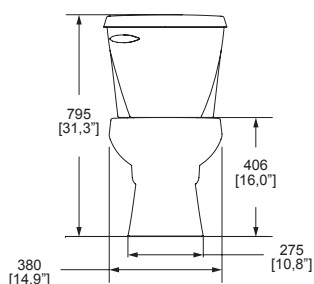

Dimensiones:
vista lateral

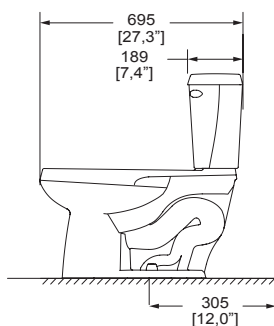

TANQUE AUSTRAL P

\$ 1,825.00



TAZA AUSTRAL

\$ 2,144.00



NOM NOM-009-CONAGUA-2001



Efecto Turvex



Taza alargada



Trampa expuesta



Mayor altura

HELVEX
Garantía de Calidad

65

Años de garantía en cerámica



WC BOLMEN16 4.8 LPD

- Inodoro, taza y tanque **BOLMEN16** elongado.
- Taza elongada de altura comfortable. con trampa **expuesta**.
- **Descarga de 4.8 LPD.**
- **Sistema Turvex.** Para una limpieza total.
- Botón accionador.
- **No incluye asiento**, se recomiendan asientos **AT-1, AT-2, ATE y ATM.**

WC BOLMEN16



Color Blanco

\$ 5,555.00

WC BOLMEN16 M



Color Marfil

\$ 5,555.00

Dimensiones:
vista frontal

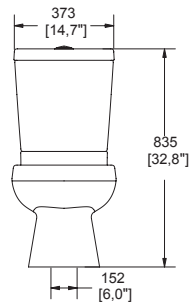

Dimensiones:
vista lateral

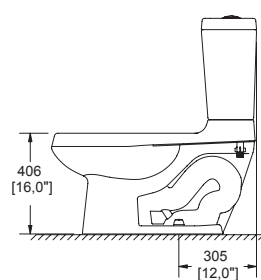

TANQUE BOLMEN16

\$ 2,221.00



Color Blanco

TANQUE BOLMEN16 M

\$ 2,221.00



Color Marfil

TAZA BOLMEN16

\$ 3,334.00



Color Blanco

TAZA BOLMEN16 M

\$ 3,334.00



Color Marfil



Efecto Turvex



Taza alargada



Trampa expuesta



Mayor altura



Grado ecológico

NOM NOM-009-CONAGUA-2001

65

Años de garantía en cerámica

WC DRAKAR16 4.8 LPD

- Inodoro, taza y tanque **DRAKAR16** elongado.
- Taza elongada de altura confortable con trampa **expuesta**.
- **Descarga de 4.8 LPD.**
- **Sistema Turvex.**
Para una limpieza total.
- Botón accionador.
- **No incluye asiento**, se recomiendan asientos **AT-1, AT-2, ATE y ATM.**



WC DRAKAR16



Color Blanco

\$ 4,545.00

Dimensiones:
vista frontal

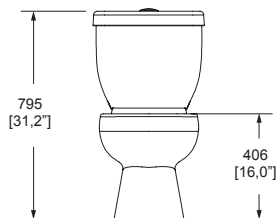

Dimensiones:
vista lateral

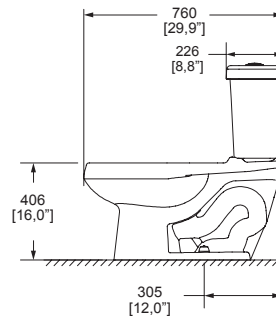

TANQUE DRAKAR16

\$ 1,820.00



Color Blanco

TAZA DRAKAR16

\$ 2,725.00



Color Blanco

NOM NOM-009-CONAGUA-2001



Grado ecológico



Efecto Turvex



Taza alargada



Trampa expuesta



Mayor altura

HELVEX
Garantía de Calidad

65

Años de garantía en cerámica



WC OLIMPIA 3.8 LPD

- Inodoro, taza y tanque **OLIMPIA** redondo.
- Taza redonda de altura tradicional con trampa **expuesta**.
- **Descarga de 3.8 LPD.**
- **Sistema Vórtice.** Limpieza total, no se tapa.
- Botón accionador.
- **No incluye asiento**, se recomiendan asientos **ATR-1 y ATR-1-M.**

WC OLIMPIA



Color Blanco

\$ 4,055.00

WC OLIMPIA M



Color Marfil

\$ 4,055.00

Dimensiones:
vista frontal

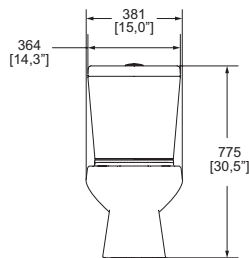

Dimensiones:
vista lateral

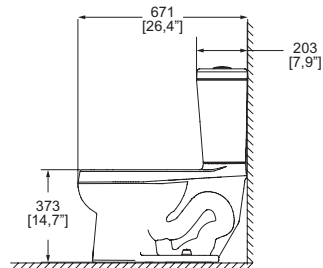

TANQUE OLIMPIA

\$ 1,620.00



Color Blanco

TANQUE OLIMPIA M

\$ 1,620.00



Color Marfil

TAZA OLIMPIA

\$ 2,435.00



Color Blanco

TAZA OLIMPIA M

\$ 2,435.00



Color Marfil



Efecto Turvex



Taza alargada



Trampa expuesta



Mayor altura



Grado ecológico

NOM NOM-009-CONAGUA-2001

WC OPTION 4.8 LPD

- Ideal para espacios reducidos.
- Inodoro, taza y tanque **OPTION** elongado compacto.
- Taza elongada compacta, de altura comfortable con trampa **expuesta**.
- **Descarga de 4.8 LPD.**
- **Sistema Turvex.**
Cuenta con **4 jets** para una limpieza total.
- Botón accionador.
- **No incluye asiento**, se recomiendan asientos **AT-1, AT-2 y AT-5.**



WC OPTION



Color Blanco

\$ 3,879.00

Dimensiones:
vista frontal

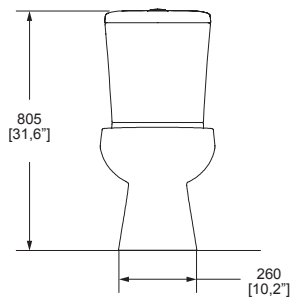

Dimensiones:
vista lateral

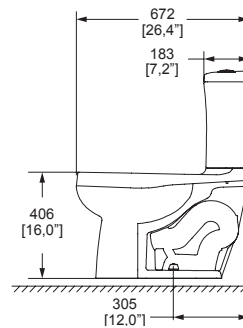

TANQUE OPTION

\$ 1,550.00



Color Blanco

TAZA OPTION

\$ 2,329.00



Color Blanco



Efecto Turvex



Taza alargada



Trampa expuesta



Mayor altura



Grado ecológico

NOM NOM-009-CONAGUA-2001

NUEVO
PRODUCTO

65

Años de garantía
en cerámica



WC OPTION P 4.8 LPD

- Ideal para espacios reducidos.
- Inodoro, taza y tanque **OPTION** elongado compacto.
- Taza elongada compacta, de altura comfortable con trampa **expuesta**.
- Descarga de **4.8 LPD**.
- **Sistema Turvex.**
Cuenta con **4 jets** para una limpieza total.
- Palanca accionadora.
- **No incluye asiento**, se recomiendan asientos **AT-1, AT-2 y AT-5**.

WC OPTION P



Color Blanco

\$ 3,879.00

Dimensiones:
vista frontal

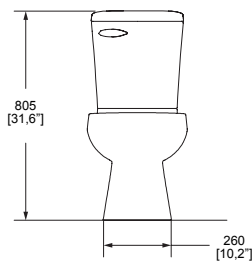

Dimensiones:
vista lateral

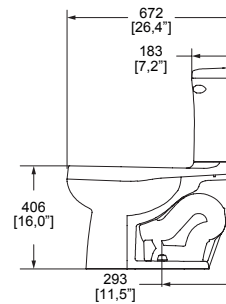

TANQUE OPTION P

\$ 1,550.00



Color Blanco

TAZA OPTION

\$ 2,329.00



Color Blanco

NOM NOM-009-CONAGUA-2001



Efecto Turvex



Taza alargada



Trampa expuesta



Mayor altura

Los precios incluyen IVA

237

HELVEX
Garantía de Calidad

WC RÓDANO16 4.8 LPD

- Inodoro, taza y tanque **RÓDANO16** elongado.
- Taza elongada de altura comfortable con trampa **expuesta**.
- **Descarga de 4.8 LPD.**
- **Sistema Turvex.**
Para una limpieza total.
- Botón accionador.
- **No incluye asiento**, se recomiendan asientos **AT-1, AT-2, ATE y ATM.**



WC RÓDANO16



Color Blanco

\$ 5,555.00

WC RÓDANO16 M



Color Marfil

\$ 5,555.00

Dimensiones:
vista frontal

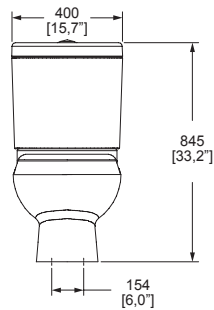

Dimensiones:
vista lateral

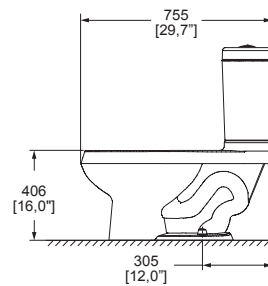

TANQUE RÓDANO16

\$ 2,221.00



Color Blanco

TANQUE RÓDANO16 M

\$ 2,221.00



Color Marfil

TAZA RÓDANO16

\$ 3,334.00



Color Blanco

TAZA RÓDANO16 M

\$ 3,334.00



Color Marfil

NOM NOM-009-CONAGUA-2001



Grado ecológico



Efecto Turvex



Taza alargada



Trampa expuesta



Mayor altura

HELVEX
Garantía de Calidad

NUEVO
PRODUCTO

65

Años de garantía
en cerámica



Utiliza 58% menos agua
que un WC estándar.

WC SUSTENTA 2.5 LPD

- Ideal para espacios reducidos.
- Inodoro, taza y tanque **SUSTENTA** elongado compacto.
- Taza elongada compacta, de altura confortable con trampa **expuesta**.
- **Descarga de 2.5 LPD.**
- **Sistema Vórtice.**
- Botón accionador.
- **No incluye asiento**, se recomiendan asientos **AT-1, AT-2, AT-4 y AT-5.**

WC SUSTENTA



Color Blanco

\$ 4,439.00

Dimensiones:
vista frontal

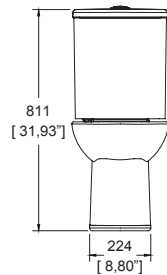

Dimensiones:
vista lateral

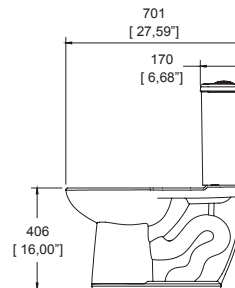

TANQUE SUSTENTA

\$ 1,776.00



Color Blanco

TAZA SUSTENTA

\$ 2,663.00



Color Blanco



Efecto Vórtice



Taza alargada



Trampa expuesta



Mayor altura



Grado
ecológico

NOM NOM-009-CONAGUA-2001

ASIENTOS CON SISTEMA DE SUJECIÓN REFORZADO



AT-1

Blanco

\$ 1,160.00

AT-1-M

Marfil

\$ 1,160.00

Asiento para WC **elongado**, frente abierto, cierre lento con antibacterial.



Dimensiones:
vista cenital

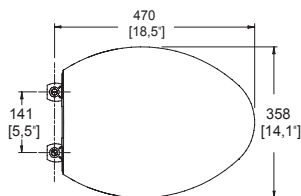

Dimensiones:
vista lateral

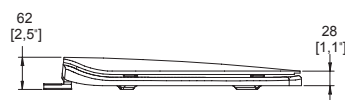

Colores.



AT-2

Blanco

\$ 736.00

Asiento para WC **elongado**, frente abierto, cierre estándar con antibacterial.



Dimensiones:
vista cenital

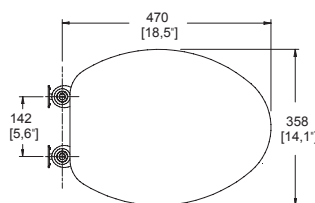

Dimensiones:
vista lateral



Color.



ASIENTOS CON SISTEMA DE SUJECIÓN REFORZADO

ATR-1

Blanco

\$ 723.00

ATR-1-M

Marfil

\$ 723.00

Asiento para WC **redondo**, frente abierto, cierre estándar con antibacterial.



Dimensiones: vista cenital

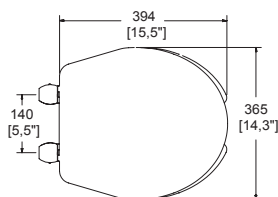

Dimensiones: vista lateral

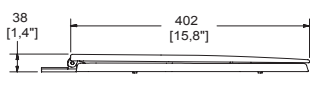

Colores.

Blanco Marfil

AT-4

Blanco

\$ 1,433.00

Asiento para WC **elongado**, con tapa envolvente, frente abierto, cierre lento con antibacterial.



Dimensiones: vista cenital

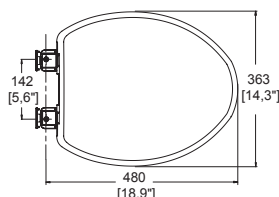

Dimensiones: vista lateral



Color.

Blanco

AT-5

Blanco

\$ 1,160.00

Asiento para WC **elongado**, con tapa envolvente, frente abierto, cierre lento con antibacterial.



Dimensiones: vista cenital

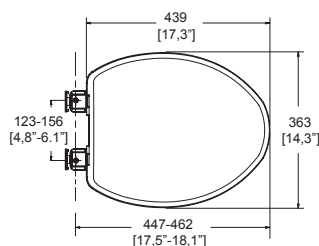

Dimensiones: vista lateral



Color.

Blanco



ATE ASIENTO ELECTRÓNICO

ATE



Color Blanco

\$ 24,936.00



De corriente



- **Compatible con WC's elongados:**

- OP Rivoli Plus.
- WC Miura16.
- WC Miura16 TCC.
- WC Ródano16.
- WC Bolmen16.
- WC Drakar.
- WC Drakar16.

- **No compatible con WC's redondos o elongados compactos.**

- **Con funciones de limpieza, secado y calefacción**
Incluye control remoto.

Dimensiones:
vista cenital

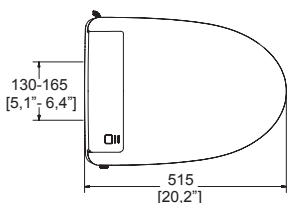

Dimensiones:
vista frontal

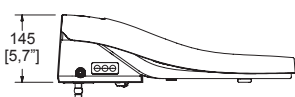

Taza alargada



No baterías



Antibacterial



Cierre lento



CARACTERÍSTICAS

- Para **WC's** elongados.
- Labio cerrado.
- Asiento **antibacterial**.
- Utiliza **corriente**.
- **Luz** nocturna.
- Memoria para **2 perfiles de usuario**.
- **Secado** con aire tibio a **6 niveles**.
- Distancia de **chorro** de agua de **5 niveles**.

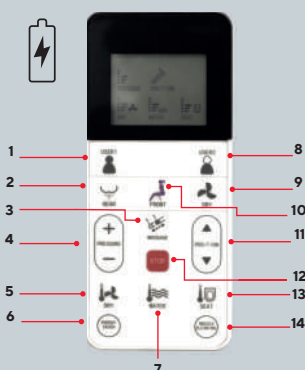

- 1 Usuario 1.
- 2 Limpieza trasera.
- 3 Masaje.
- 4 Presión del agua.
- 5 Temperatura de secado.
- 6 Ahorro de energía.
- 7 Temperatura del agua.
- 8 Usuario 2.
- 9 Secado.
- 10 Limpieza delantera.
- 11 Posición de la boquilla de rociado.
- 12 Parar.
- 13 Temperatura del asiento.
- 14 Limpieza de la boquilla de rociado.



ASIENTO ATM TIPO BIDET MECÁNICO

ATM



Color Blanco

\$ 4,110.00



Limpieza alternativa al papel higiénico, ya que incluye un dispositivo tipo bidet, que arroja agua para limpieza frontal y rectal, generando ahorros sustanciales.

Es el sustituto ideal de papel higiénico, ya que ofrece mayor limpieza y suavidad.

Ideal para personas con problemas de hemorroides, movilidad o con operaciones recientes.

- **Asiento mecánico**, con funciones tipo Bidet;

Compatible con :

- WC's elongados:
- OP Rivoli Plus.
- WC Miura16.
- WC Miura16 TCC.
- WC Ródano16.
- WC Bolmen16.
- WC Drakar.
- WC Drakar16.

- **No compatible con WC's redondos o elongados compactos.**

- **Incluye antibacterial.**

- **Presión de agua mínima requerida 0.40 kg/cm².**

Dimensiones:
vista cenital

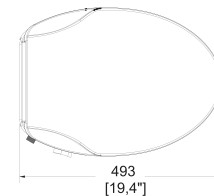

Dimensiones:
vista frontal



De cierre lento
Evita que el asiento
se maltrate.

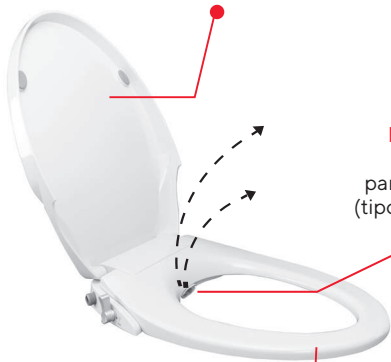

Dispositivo que
arroja agua
para limpieza frontal
(tipo bidet) y posterior.

Labio cerrado.



Taza alargada



No baterías



Antibacterial



Cierre lento



3 niveles de
intensidad

TZF NAO

Blanco

\$ 5,165.00

Taza Nao para fluxómetro, **elongada**, trampa expuesta 3.5 LPD / 4.8 LPD.



Dimensiones:
vista frontal

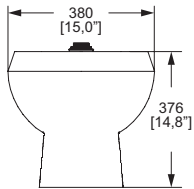

Dimensiones:
vista lateral

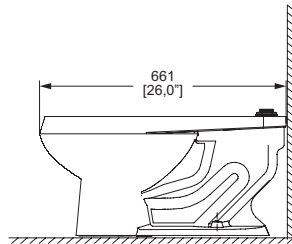

Cerámica al alto brillo, grado de calidad "A", grueso espesor en la cerámica para mayor resistencia, trampa esmaltada, base rectificada, descarga rápida, desalojo perfecto, no se tapa, sistema de sujeción reforzado, amplio espejo de agua que favorece la limpieza de la taza. **No incluye asiento.**

Blanco

TZF NAO17

Blanco

\$ 5,165.00

Taza Nao17 para fluxómetro, **elongada**, trampa expuesta. Altura confortable 3.5 LPD / 4.8 LPD.



Dimensiones:
vista frontal

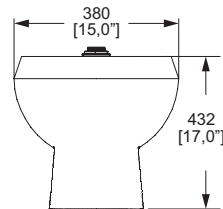

Dimensiones:
vista lateral

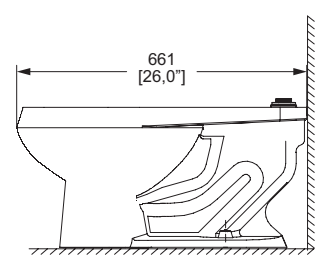

Cerámica al alto brillo, grado de calidad "A", grueso espesor en la cerámica para mayor resistencia, trampa esmaltada, base rectificada, descarga rápida, desalojo perfecto, no se tapa, sistema de sujeción reforzado, amplio espejo de agua que favorece la limpieza de la taza. **No incluye asiento.**

Blanco

Para las tazas NAO y NAO17 se recomienda el uso de los fluxómetros de 3.5, 4.8 y 6 Litros

DESALOJA 1 kg

Altura confortable
NAO17



NOM NOM-009-CONAGUA-2001



Sistema Vórtice



Desalojo perfecto



Taza alargada



Grado ecológico



Modelos especiales que le ayudarán a obtener puntos para la certificación LEED



65

Años de garantía en cerámica

ASIENTOS PARA TAZAS CON FLUXÓMETRO

AF-1

Blanco

\$ 637.00

Asiento elongado para taza fluxómetro sin tapa.



Dimensiones:
vista frontal

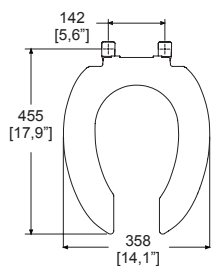

Dimensiones:
vista lateral



Color.

Blanco

AF-2

Blanco

\$ 1,271.00

Asiento plus elongado para taza fluxómetro sin tapa **con antibacterial**



Dimensiones:
vista frontal

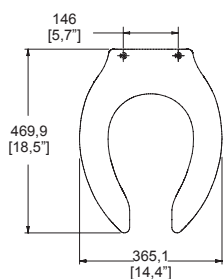

Dimensiones:
vista lateral



Asiento más robusto, con sistema de fijación reforzado. El asiento NO se mueve.

Blanco



TZF NAO P

Blanco

\$ 5,580.00

Taza para fluxómetro a pared.
Trampa semi oculta,
6 LPD.
Ecológico 3.5 LPD / 4.8 LPD.



Dimensiones:
vista cenital

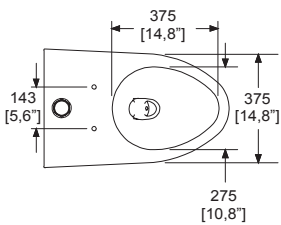

Dimensiones:
vista lateral

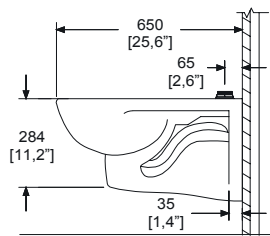

Diseño ergonómico.
Máxima eficiencia en descarga.
Cerámica porcelanizada de alto brillo; Calidad "A".
No Incluye asiento; compatible con los modelos AF-1 y AF-2.

Blanco

S-TZF-P

Hierro fundido

\$ 4,511.00

Soporte para taza
TZF Nao a Pared
ajustable para dos alturas.

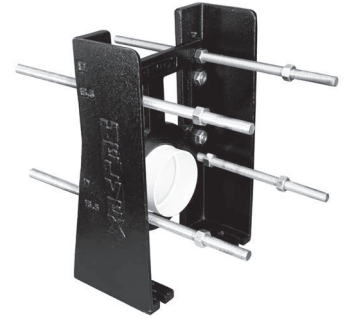

Dimensiones:
vista frontal

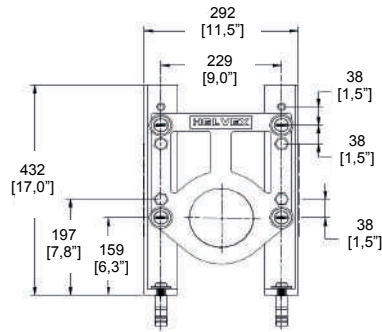

Dimensiones:
vista lateral

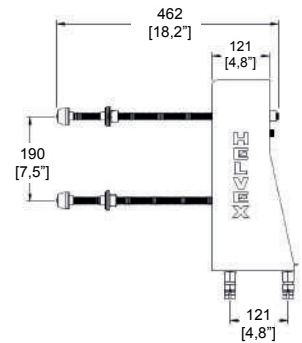

Carga máxima: 300 Kg.

Se recomienda instalar con
sistema de sujeción
S-TZF-P a pared (no incluido)

DESALOJA 1 kg

Altura confortable



NOM NOM-002-CONAGUA-2021



Sistema Vórtice



Desalojo perfecto



Taza alargada



Grado ecológico



Modelos especiales que le
ayudarán a obtener puntos
para la certificación LEED



65

Años de garantía
en cerámica

MINGITORIOS TIPO CASCADA

MG FERRY

Blanco

\$ 8,691.00

Mingitorio Ferry
Flujo tipo cascada.
Se recomienda
su uso con fluxómetro
de **1 LPD ó 0.5 LPD.**

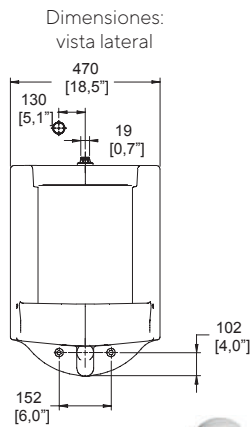
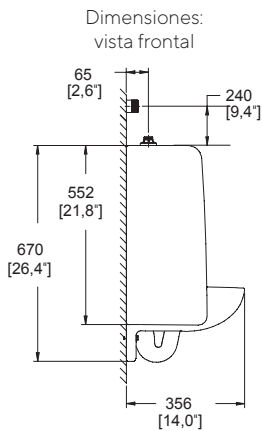

Cerámica al alto brillo, grado de calidad "A", grueso espesor en la cerámica para mayor resistencia, sistema de sujeción reforzado.

Blanco

MG MOJAVE

Blanco

\$ 6,653.00

Mingitorio Mojave
Flujo tipo cascada.
Se recomienda
su uso con fluxómetro
de **1 LPD.**

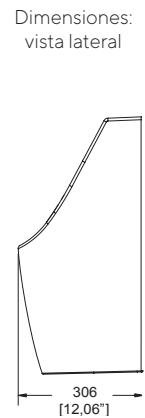
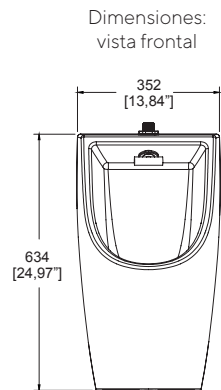

Cerámica al alto brillo, grado de calidad "A", grueso espesor en la cerámica para mayor resistencia, sistema de sujeción reforzado.

Blanco

NOM NOM-002-CONAGUA-2021



Modelos especiales que le ayudarán a obtener puntos para la certificación LEED



Grado ecológico

Los precios incluyen IVA

247

HELVEX
Garantía de Calidad





MINGITORIOS SECOS

MG MOJAVE TDS2

Blanco

\$ 8,965.00

Mingitorio Seco Mojave con sistema **TDS2** (Tecnología Drena y Sella con Doble esfera).



Dimensiones:
vista frontal

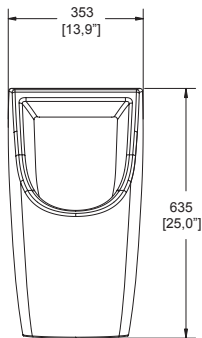

Dimensiones:
vista lateral

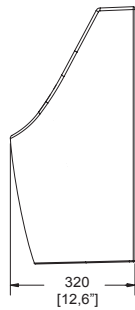

Producto Ahorrador



Blanco

Color.

MG NEGEV TDS2

Blanco

\$ 11,714.00

Mingitorio Seco Negev con sistema **TDS2** (Tecnología Drena y Sella con Doble esfera).



Dimensiones:
vista frontal

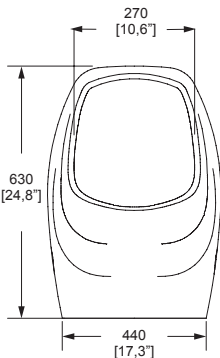

Dimensiones:
vista lateral

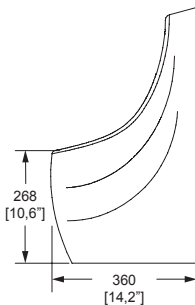

Producto Ahorrador



Blanco

PREMIO **eco**
CIHAC



65
Años de garantía
en cerámica



Modelos especiales que le ayudarán a obtener puntos para la certificación LEED



MG GOBI TDS2

Blanco

\$ 11,714.00

Mingitorio Seco Gobi con sistema **TDS2** (Tecnología Drena y Sella con Doble esfera).



Dimensiones:
vista frontal

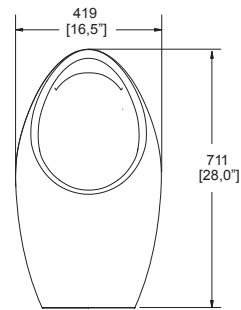

Dimensiones:
vista lateral

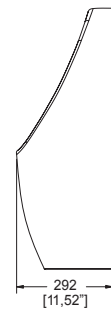

PREMIO **eco**
CIHAC



Producto
Ahorrador



Blanco



Modelos especiales que le ayudarán a obtener puntos para la certificación LEED



Cerámica al alto brillo, grado de calidad "A", grueso espesor en la cerámica para mayor resistencia, sistema de sujeción reforzado. Con sistema **TDS2** (Tecnología Drena y Sella con doble esfera). El sistema TDS2 no permite el paso de malos olores.

Con la Tecnología Drena y Sella de doble esfera,
cada mingitorio seco **PUEDA AHORRAR**
HASTA 164,000 LITROS AL AÑO.



LV ALASKA

Blanco

\$ 3,695.00

Lavabo de **sobreponer** sin rebosadero.



Dimensiones:
vista cenital

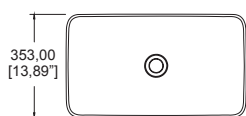

Dimensiones:
vista lateral

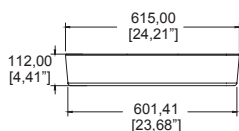

Cerámica al alto brillo, grado de calidad "A" y grueso espesor.

Blanco

LV ANNI

Blanco

\$ 2,091.00

Lavabo de **una perforación** de sobreponer con rebosadero.



Dimensiones:
vista cenital

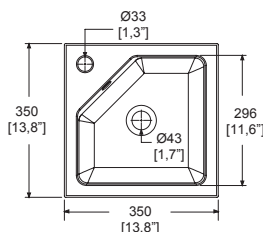

Dimensiones:
vista lateral

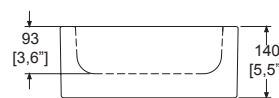

Para espacios reducidos.

Cerámica al alto brillo, grado de calidad "A" y grueso espesor.

Blanco

LV NARI

Blanco

\$ 3,695.00

Lavabo de **sobreponer** sin rebosadero.



Dimensiones:
vista cenital

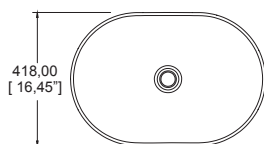

Dimensiones:
vista lateral

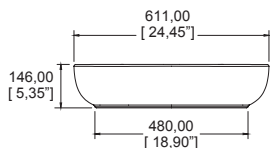

Cerámica al alto brillo, grado de calidad "A" y grueso espesor.

Blanco

LV SIRÁ

Blanco

\$ 3,695.00

Lavabo de **sobreponer** sin rebosadero.



Dimensiones:
vista cenital

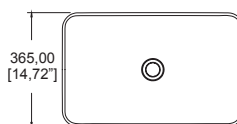

Dimensiones:
vista lateral

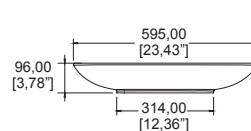

Cerámica al alto brillo, grado de calidad "A" y grueso espesor.

Blanco



LV CASSINI

Blanco

\$ 1,936.00

LV CASSINI M

Marfil

\$ 1,936.00

Lavabo de **sobreponer** sin rebosadero.



Dimensiones:
vista cenital

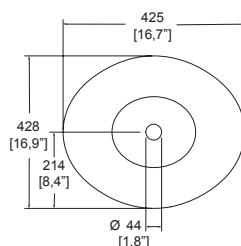

Dimensiones:
vista lateral



Cerámica al alto brillo, grado de calidad "A" y grueso espesor.



LV CLAP

Blanco

\$ 2,103.00

Lavabo de **sobreponer** sin rebosadero.



Dimensiones:
vista cenital

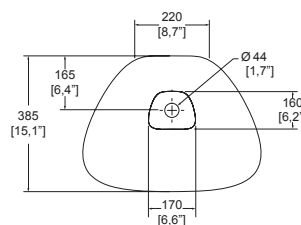

Dimensiones:
vista lateral

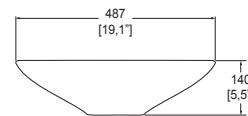

Cerámica al alto brillo, grado de calidad "A" y grueso espesor.



LAVABOS DE SOBREPONER

LV FUTURA1

Blanco

\$ 3,695.00

LV FUTURA1 M

Marfil

\$ 3,695.00

Lavabo de **una perforación** de sobreponer con rebosadero.



Dimensiones:
vista cenital

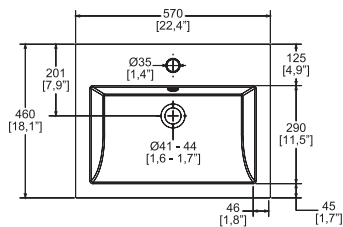

Dimensiones:
vista lateral



Cerámica al alto brillo, grado de calidad "A" y grueso espesor.



Blanco Marfil

LV LUCERNA1

Blanco

\$ 3,695.00

LV LUCERNA1 M

Marfil

\$ 3,695.00

Lavabo de **una perforación** de sobreponer con rebosadero.



Dimensiones:
vista cenital

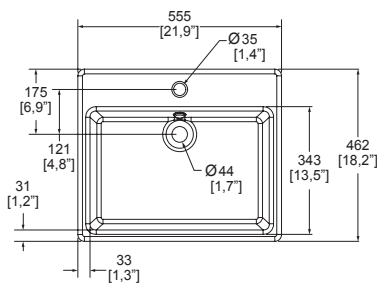

Dimensiones:
vista lateral

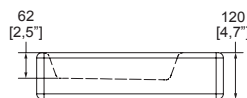

Cerámica al alto brillo, grado de calidad "A" y grueso espesor.



Blanco Marfil



LV LUCERNA3

Blanco

\$ 3,695.00



LV LUCERNA3 M

Marfil

\$ 3,695.00

Lavabo de **tres perforaciones** de sobreponer con rebosadero.

Dimensiones:
vista cenital

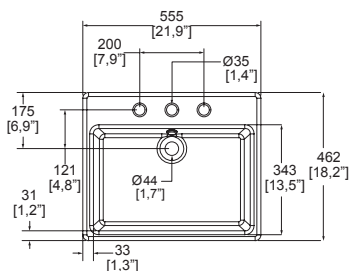

Dimensiones:
vista lateral

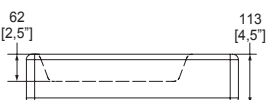

Cerámica al alto brillo, grado de calidad "A" y grueso espesor.



LV MOREA

Blanco

\$ 1,403.00



Lavabo de **sobreponer** sin rebosadero.

Cerámica al alto brillo, grado de calidad "A" y grueso espesor.



LV MOREA EB

Ébano

\$ 1,838.00



Lavabo de **sobreponer** sin rebosadero.

Cerámica grado de calidad "A" y grueso espesor.



LV TRAZZO

Blanco

\$ 2,215.00



LV TRAZZO M

Marfil

\$ 2,215.00

Lavabo de **sobreponer** sin rebosadero

Dimensiones:
vista cenital

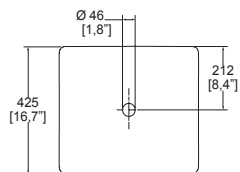

Dimensiones:
vista lateral



Cerámica al alto brillo, grado de calidad "A" y grueso espesor.

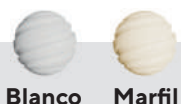

Dimensiones:
vista cenital

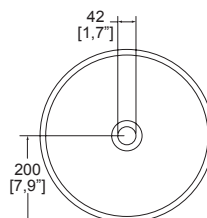

Dimensiones:
vista lateral

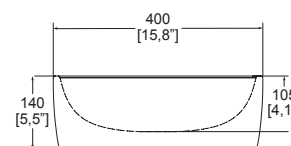

Cerámica grado de calidad "A" y grueso espesor.

LAVABOS DE SOBREPONER

LV MOREA1

Blanco

\$ 1,578.00

Lavabo de **una perforación** de sobreponer con rebosadero con **inserto cromado**.



Dimensiones:
vista cenital

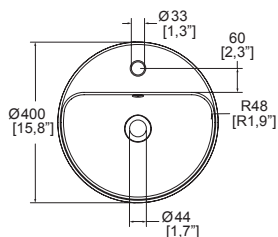

Dimensiones:
vista lateral

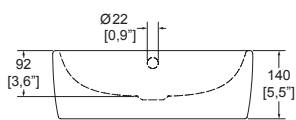

Cerámica al alto brillo, grado de calidad "A" y grueso espesor.

Blanco

LV SANTORINI

Blanco

\$ 1,757.00

Lavabo de **sobreponer** sin rebosadero



Dimensiones:
vista cenital

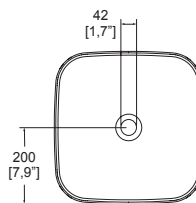

Dimensiones:
vista lateral

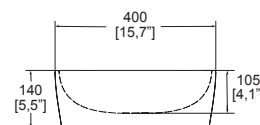

Cerámica al alto brillo, grado de calidad "A" y grueso espesor.

Blanco

LV SANTORINI1

Blanco

\$ 2,091.00

Lavabo de **una perforación** de sobreponer con rebosadero con **inserto cromado**.



Dimensiones:
vista cenital

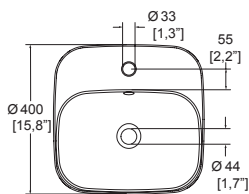

Dimensiones:
vista lateral

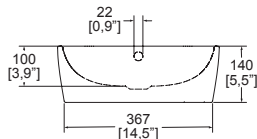

Cerámica al alto brillo, grado de calidad "A" y grueso espesor.

Blanco



LV ELIPSIS

Blanco

\$ 1,403.00



Lavabo de **sobrecubierta** sin rebosadero.



Dimensiones:
vista cenital

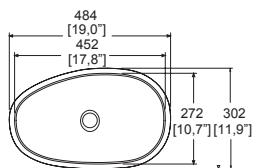

Dimensiones:
vista lateral

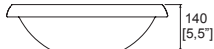

Para espacios reducidos

Cerámica al alto brillo, grado de calidad "A" y grueso espesor.

Blanco

LV STALA

Blanco

\$ 2,260.00

Lavabo de **doble instalación (sobreponer y sobrecubierta)** sin rebosadero.



Dimensiones:
vista cenital

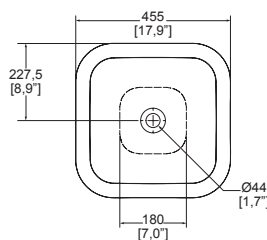

Dimensiones:
vista lateral

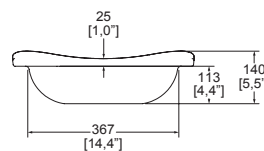

Cerámica al alto brillo, grado de calidad "A" y grueso espesor.

Blanco

LV MARCUS

Blanco

\$ 2,203.00



LV MARCUS M

Marfil

\$ 2,203.00

Lavabo de **sobrecubierta** con rebosadero

Dimensiones:
vista cenital

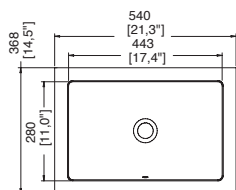

Dimensiones:
vista lateral

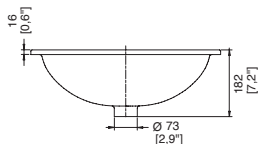

Cerámica al alto brillo, grado de calidad "A" y grueso espesor.

Blanco Marfil



LAVABOS DE BAJOCUBIERTA

LV MARCUS BC

Blanco

\$ 2,385.00

LV MARCUS BC M

Marfil

\$ 2,385.00

Lavabo de **bajocubierta** con rebosadero.



Dimensiones:
vista cenital

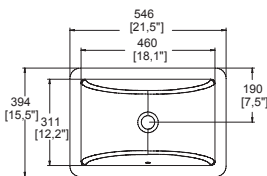

Dimensiones:
vista lateral

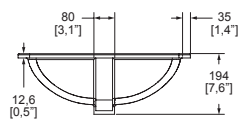

Cerámica al alto brillo, grado de calidad "A" y grueso espesor.



LV LUGANO

Blanco

\$ 1,762.00

Lavabo de **bajocubierta** con rebosadero



Dimensiones:
vista cenital

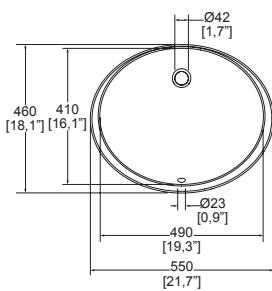

Dimensiones:
vista lateral

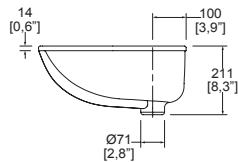

Cerámica al alto brillo, grado de calidad "A" y grueso espesor.





VÁLVULA DE PASO

TV-012

Cromo

\$ 807.00

Válvula de paso roscable.

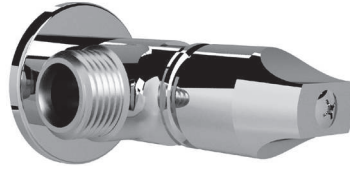

Dimensiones:
vista frontal

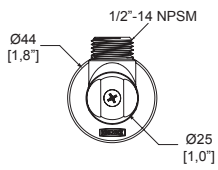

Dimensiones:
vista lateral

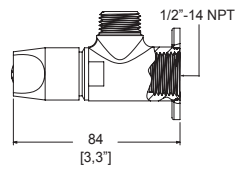

100% latón.
Para instalarse en lavabos, fregaderos y WC.



CR



PAQUETES



INSTITUCIONALES

PAQUETES INSTITUCIONALES



COMBINACIÓN DE
**PRODUCTOS
HELVEX**
LA FÓRMULA PARA UN
**EXCELENTE
DESEMPEÑO**



Visite nuestra página web para consultar y descargar
fichas técnicas e instructivos de instalación.
helvex.com     



PAQUETES INSTITUCIONALES

MÁXIMO AHORRO DE AGUA

3 EN 1

Al adquirir un paquete Helvex puedes obtener hasta TRES PRODUCTOS a precio especial en UNA SOLA CAJA (*en los paquetes 1, 2, 3, 4, 5 y 6 que incluyen fluxómetro, taza y asiento)

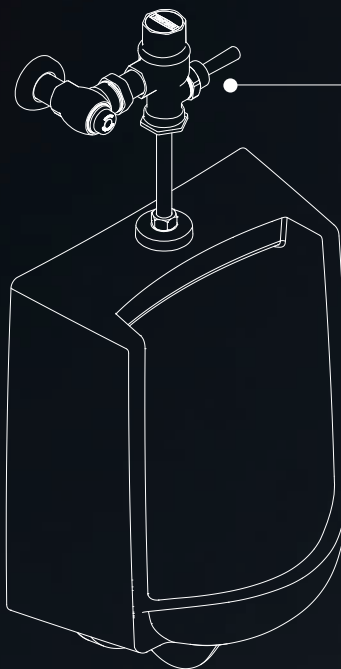

Descarga MÁXIMA de:
1 litro por descarga en mingitorios

3.5 litros por descarga en tazas flux
ÚNICO EN EL MERCADO

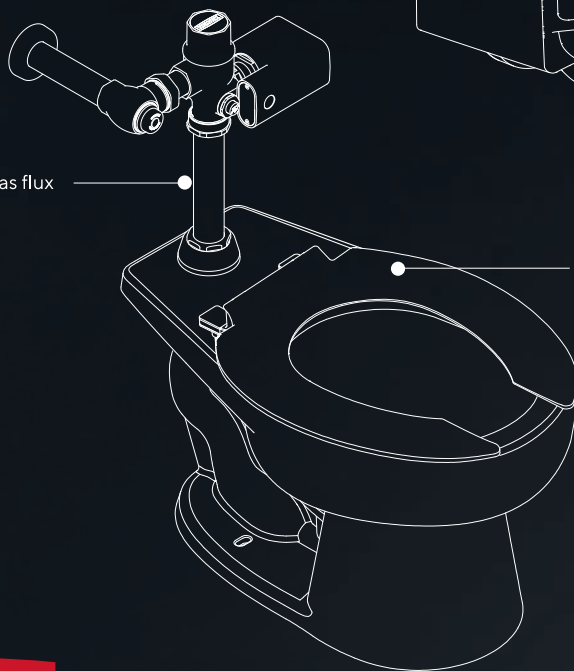

INCLUYE ASIENTO

Los paquetes 1, 2, 3, 4, 5 y 6 que incluyen fluxómetro, taza y asiento



HELVEX

Garantía de Calidad

GASTO:
3.2 L a 3.5 L
por accionamiento.
CUMPLE CON LA NORMA:
NOM-002-CONAGUA-2021
NOM-001-SCFI-2018

FLUXÓMETRO DE MANIJA

1 NAO 1-3.5

PAQUETE

Fluxómetro de manija

110-38-3.5

3.5 litros por descarga

Presión mínima requerida:
2.00 kg/cm²



ASIENTO
AF-1

Taza Nao para fluxómetro
TZF NAO

Incluye asiento. No se aceptan devoluciones de los componentes del paquete por separado. Este producto no entra en otras promociones.

Precio **\$ 8,520.00**



FLUXÓMETRO DE MANIJA

2 NAO17 1-3.5 
PAQUETE

Fluxómetro de manija
110-38-3.5
3.5 litros por descarga
Presión mínima requerida:
2.00 kg/cm²



Taza Nao para fluxómetro
TZF NAO17 

Incluye asiento. No se aceptan devoluciones de los componentes del paquete por separado. Este producto no entra en otras promociones.

Precio **\$ 8,520.00**

FLUXÓMETRO DE SENSOR DE BATERÍAS

3 NAO FB-3.5
PAQUETE

Fluxómetro de sensor 
FB-110-38-3.5
3.5 litros por descarga
Requiere baterías alcalinas AA
Presión mínima requerida:
2.00 kg/cm²



Taza Nao para fluxómetro
TZF NAO

Incluye asiento. No se aceptan devoluciones de los componentes del paquete por separado. Este producto no entra en otras promociones.

Precio **\$ 14,213.00**

FLUXÓMETRO DE SENSOR
DE BATERÍAS

4 NAO17 FB-3.5

PAQUETE

Fluxómetro de sensor 

FB-110-38-3.5

3.5 litros por descarga

Requiere baterías alcalinas AA

Presión mínima requerida:

2.00 kg/cm²



Taza Nao para fluxómetro

TZF NAO17 

Incluye asiento. No se aceptan devoluciones de los componentes del paquete por separado. Este producto no entra en otras promociones.

Precio **\$ 14,213.00**



FLUXÓMETRO DE SENSOR
DE CORRIENTE

5 NAO FC-3.5
PAQUETE

Fluxómetro de sensor 

FC-110-38-3.5

3.5 litros por descarga

Presión mínima requerida:

2.00 kg/cm²



**ASIENTO
AF-1**

Taza Nao para fluxómetro
TZF NAO

Incluye asiento. No se aceptan devoluciones
de los componentes del paquete por separado.
Este producto no entra en otras promociones.

Precio **\$ 14,213.00**

FLUXÓMETRO DE SENSOR DE CORRIENTE

6 NAO17 FC-3.5

PAQUETE

Fluxómetro de sensor 

FC-110-38-3.5

3.5 litros por descarga

Presión mínima requerida:
2.00 kg/cm²



ASIENTO
AF-1



Taza Nao para fluxómetro

TZF NAO17 

Incluye asiento. No se aceptan devoluciones de los componentes del paquete por separado. Este producto no entra en otras promociones.

Precio **\$ 14,213.00**

FLUXÓMETRO CON MINGITORIO

7 FERRY 1-1

PAQUETE

Fluxómetro de manija

185-19-1

1 litro por descarga

Presión mínima requerida:
1.00 kg/cm²



Mingitorio
MG FERRY

No se aceptan devoluciones de los componentes del paquete por separado. Este producto no entra en otras promociones.

Precio **\$ 9,112.00**

FLUXÓMETRO
CON MINGITORIO

FLUXÓMETRO
CON MINGITORIO

8 FERRY FB-1
PAQUETE

9 FERRY FC-1
PAQUETE

Fluxómetro de sensor
FB-185-19-1 
1 litro por descarga
Requiere baterías alcalinas AA
Presión mínima requerida:
1.00 kg/cm²

Fluxómetro de sensor
FC-185-19-1 
1 litro por descarga
Presión mínima requerida:
1.00 kg/cm²



Mingitorio
MG FERRY

Mingitorio
MG FERRY

No se aceptan devoluciones de los componentes del paquete por separado. Este producto no entra en otras promociones.

No se aceptan devoluciones de los componentes del paquete por separado. Este producto no entra en otras promociones.

Precio **\$ 14,746.00**

Precio **\$ 14,746.00**

TARJETA

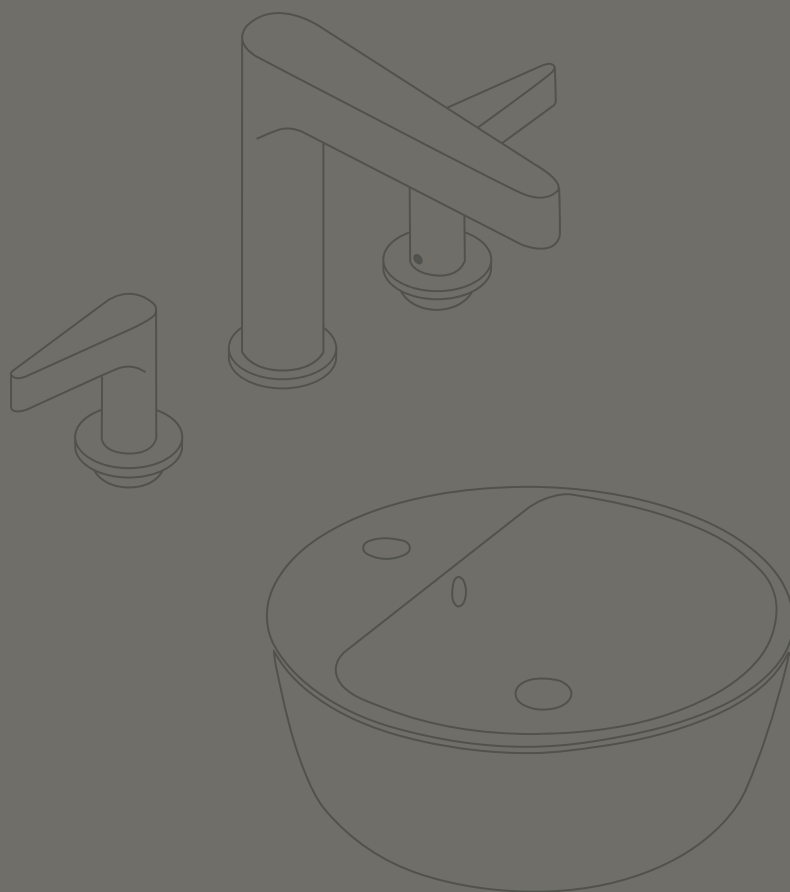

HELVEX[®]

Garantía de **Calidad**

HELVEX, S.A. DE C.V. Calzada Coltongo #293, Colonia Industrial Vallejo C.P. 02300, Alcaldía Azcapotzalco, Ciudad de México, Tel. (55) 5333-9400 y asistencia técnica al (55) 5333-9431

síguenos    helvex.com